

AM · FM · TELEVISION

# BROADCAST

NEWS



Four Versatile TV Station Equipment Plans . . . . Pg. 30



# Put the **3rd dimension** into UHF/VHF station planning—

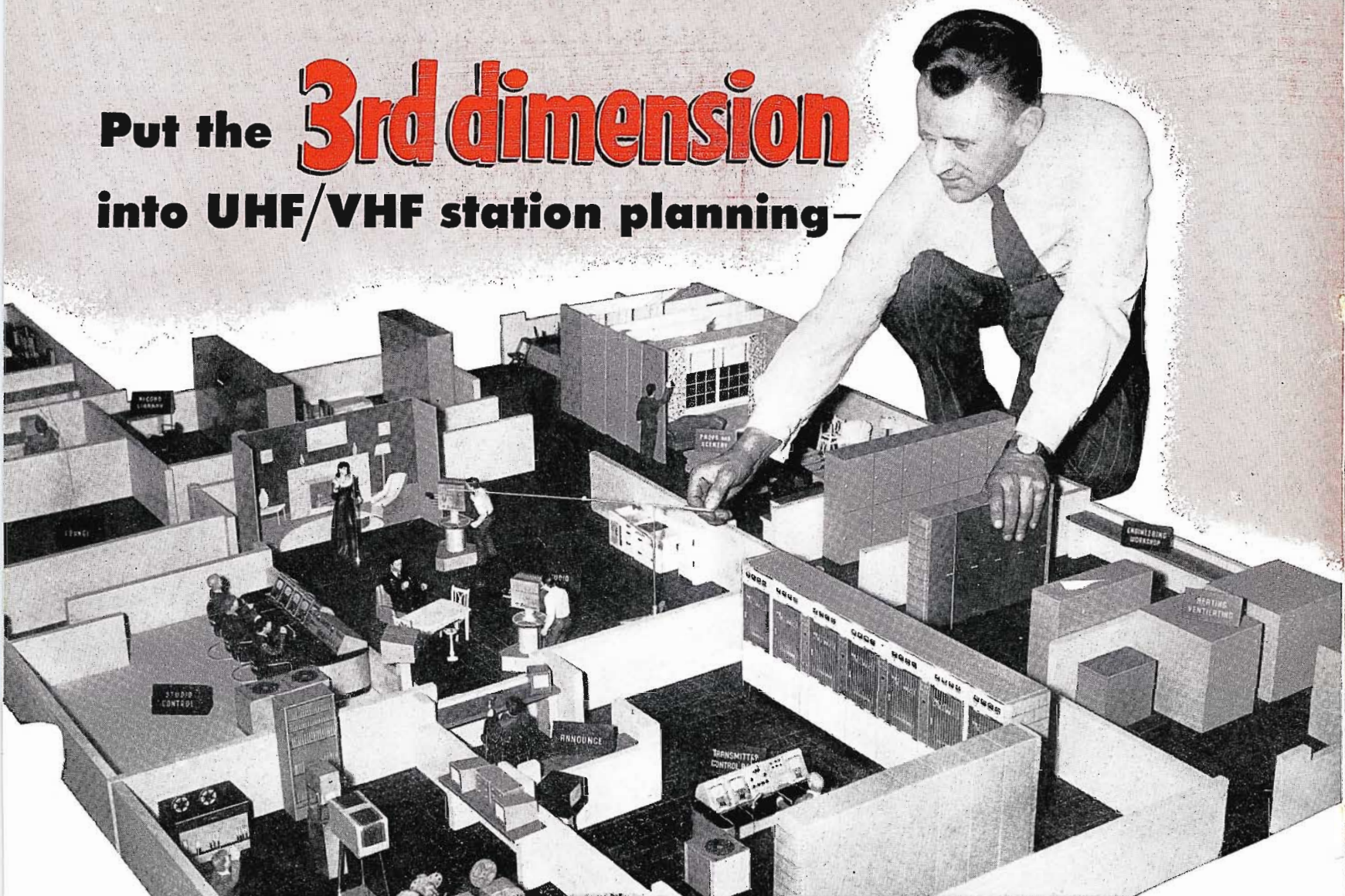

## —with RCA *exact scale* MODELS

- You see the station as it actually will look
- You can work out layouts faithfully and accurately—plan with confidence
- You work with exact replicas of RCA's newest UHF and VHF equipment

### For UHF and VHF transmitter rooms

40 pages of paper cut-outs covering 7 different RCA UHF and VHF transmitters—25/20kw power amplifiers—50kw power amplifiers—input and monitoring equipments—transmitter consoles—power equipment, etc.

### For studio and control rooms

22 pages of paper cut-outs on RCA Studio Cameras—16mm TV film projectors—a 35mm film projector—film cameras—program and audio-video consoles—transcription turntables—studio and film equipment racks, etc.

For copies of these indispensable UHF and VHF station-planning aids, call your RCA Broadcast Sales Representative. Or write on your broadcast station letterhead to Section 15-6, RCA Engineering Products, Camden, N. J.



Price \$2.00 each



**RADIO CORPORATION of AMERICA**  
ENGINEERING PRODUCTS DEPARTMENT  
CAMDEN, N. J.

# Broadcast News

AM • FM • TELEVISION

• • •

Published by the

RADIO CORPORATION OF AMERICA

ENGINEERING PRODUCTS DEPARTMENT . . . CAMDEN, NEW JERSEY

NUMBER 73

MARCH-APRIL, 1953

### Subscription Rates

In continental U. S. A. - \$4.00 for 12 issues  
In other countries . . . - \$5.00 for 12 issues

JOHN P. TAYLOR, Editor

W. O. HADLOCK, Managing Editor

E. C. MASON, Associate Editor

## Contents

WFPG-TV, ATLANTIC CITY, N. J. (UHF CHANNEL 46) . . . . .	by FRED WEBER AND BLAIR THRON	6
WBRE COMPLETES A UHF TELEVISION INSTALLATION (UHF CHANNEL 28) . . . . .	by DAVID M. BALTIMORE	12
WSBA-TV, YORK, PA. (UHF CHANNEL 43) . . . . .	by PHILLIP K. EBERLY	18
WSBT-TV, SOUTH BEND, IND. (UHF CHANNEL 34) . . . . .	by A. R. O'NEIL AND S. N. HAGENAU	22
WKNB-TV, NEW BRITAIN, CONN. (UHF CHANNEL 30) . . . . .	by JOHN SHIPLEY	26
FOUR VERSATILE TV STATION EQUIPMENT PLANS FOR VHF AND UHF . . . . .	by L. E. ANDERSON AND W. O. HADLOCK	30
General Planning Considerations . . . . .		32
TV Station Plan "A" . . . . .		36
TV Station Plan "A-Prime" . . . . .		42
TV Station Plan "B" . . . . .		48
TV Station Plan "C" . . . . .		60
FIELD INTENSITY METERS AND R-F TEST SET FOR TELEVISION . . . . .	by IRL T. NEWTON, JR.	72

Copyright 1953  
Radio Corporation of America  
RCA Victor Division  
Camden, N. J.

**COVER** of this issue shows a part of one of the TV Station Models made up to illustrate the story on TV Equipment Plans (Pg. 30). We are especially proud of this cover because it is, in unusual degree, our own "home talent" production. The models were planned and put together by Bill Hadlock, our managing editor. The color photos were made by Rod Allen of our photographic department. And the girl on the cover is Lucilla Gallagher, whose regular job is supervising the production and distribution of our Engineering Products Catalog pages.

**TV EQUIPMENT PLANS** for stations of various sizes are discussed at length in the article starting on Pg. 30. The general features of these plans represent the careful and considered judgment of TV station experts who have had a large amount of experience with stations now on the air. They told us what facilities were needed. After that, our TV Systems Engineering group under the direction of L. E. Anderson, drew up the detailed lists of equipment necessary to provide those facilities. Thus, these plans represent the best station experience plus the best design engineering experience. They are, without question, the best worked-out plans available today.

**TV STATION COSTS** were discussed at length in BROADCAST NEWS Vol. Nos. 68 and 69 by Joe Herold. The four station sizes which Joe used as a basis for his computations are the same as those used in the article in this issue. Thus station owners considering these equipment plans can get a good idea of corresponding station construction and operating costs by referring to his articles.

**TV STATION PLANS** were described by Adler and Brugnoli in BROADCAST NEWS Vol. No. 72. Here also, the four categories of stations for which they suggested building plans are the same as those referred to in the equipment planning article in this issue, and the articles on station costs by Joe Herold. Thus, by studying the material in this series of articles it is possible to make an overall station plan which will include basic information on (a) equipment, (b) building, (c) construction cost, (d) operating cost. We believe that this is the first time that complete, fully-coordinated information of this type has been available.

**STATION MODELS** shown on cover, and on Pg. 30 to 72, will be exhibited at the NARTB Convention, April 28-May 1. The components of these models are not permanently affixed to the base but rather are loose so that they may be moved around at will. This makes it possible to try different variations of the several layouts. We invite present and prospective TV planners to come in and play with these models to their hearts' content. And, of course, incidentally, you can take advantage of the opportunity to inspect most of the equipment units "in the flesh".

**STATION EQUIPMENT** we will include in our NARTB equipment includes a complete 1 kw UHF TV Station "package", our brand new 10 kw VHF TV transmitter, UHF and VHF antenna sections, TV cameras and film equipment, and a large assortment of TV accessory equipment. Also the 5/10G AM transmitter with sliding door construction, the BC-2B control console and other audio gear.

**COME SEE US** at the NARTB in our exhibit space in the Renaissance Room of the Biltmore Hotel, and in our reception headquarters, Suite 2205 in the Biltmore. For many of us this is our once-a-year chance to renew old acquaintances. Most of our sales people and many of our engineers will be there. Whether on business or pleasure, we look forward to seeing you!

# See RCA's "Package"

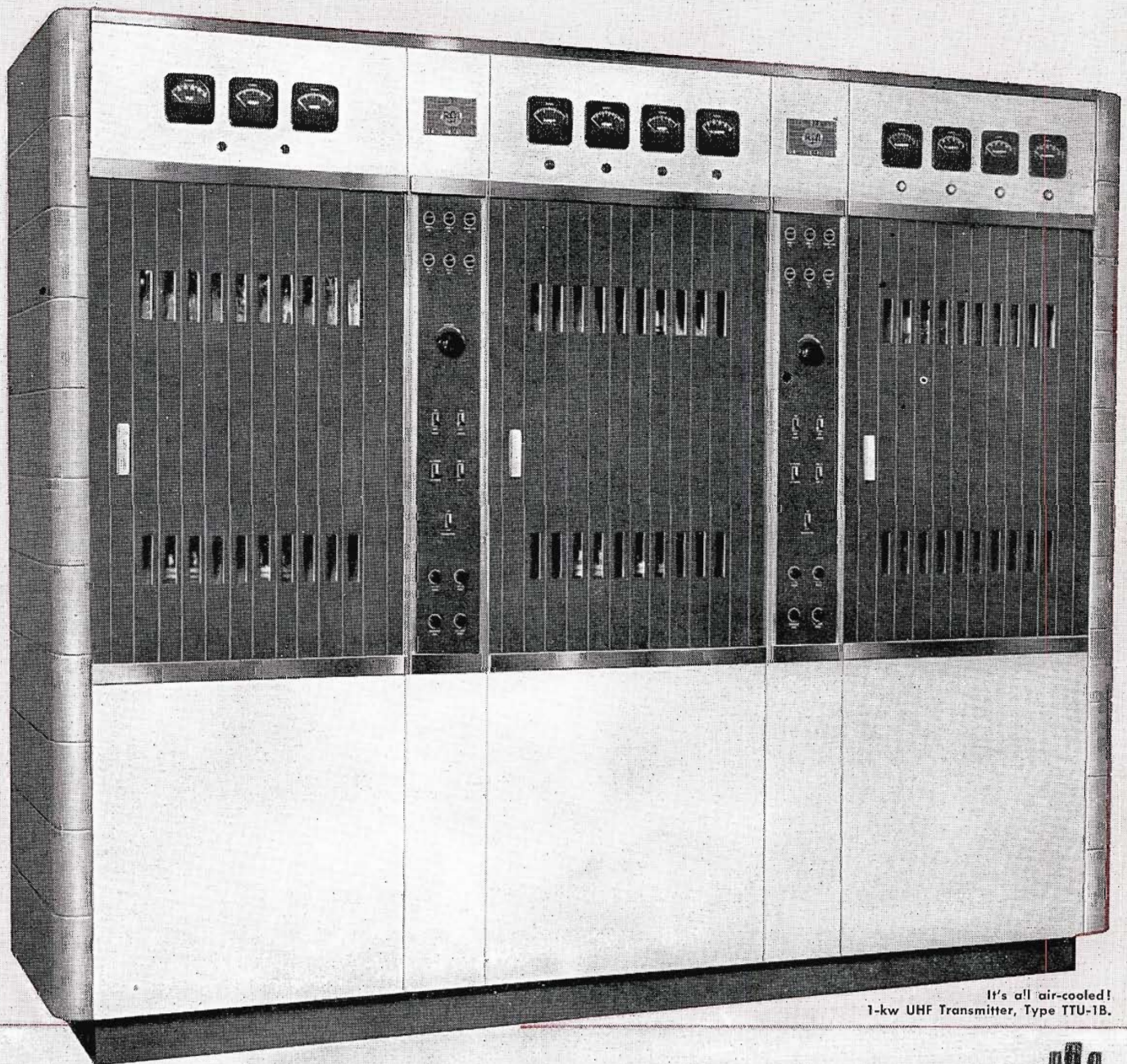

It's all air-cooled!  
1-kw UHF Transmitter, Type TTU-1B.

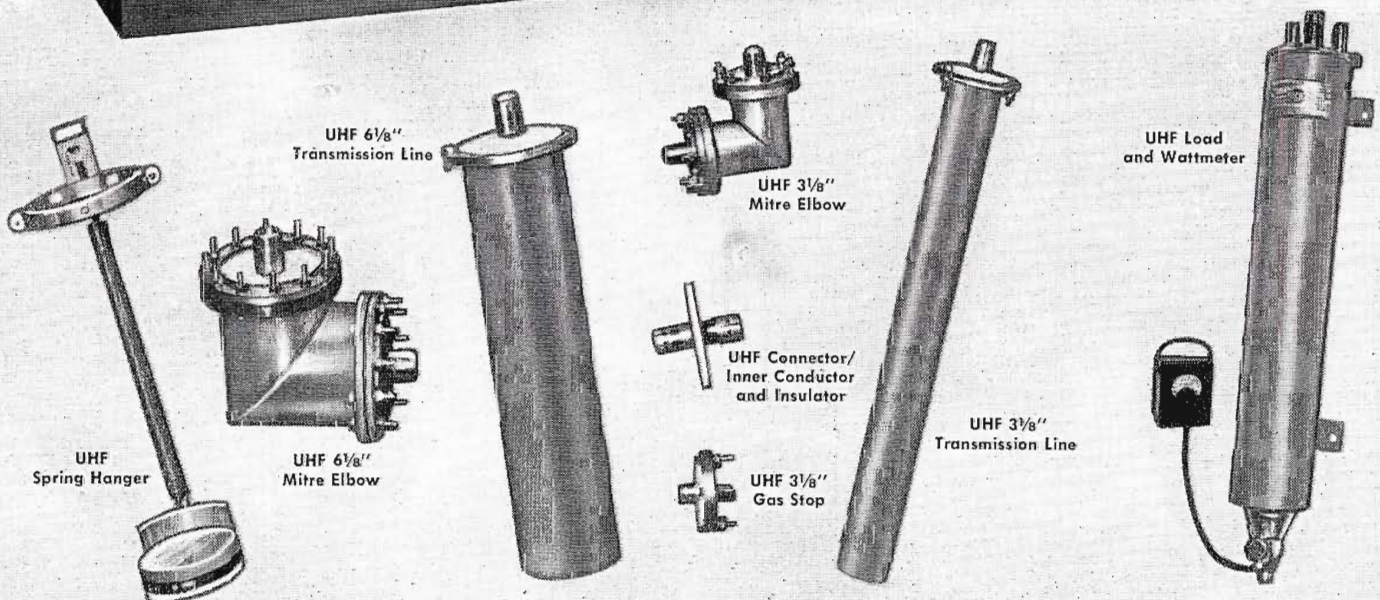

*for*

# UHF

**at the NARTB  
RENAISSANCE ROOM - HOTEL BILTMORE**

For the convenience of the broadcasters and station consultants at the NARTB, RCA has shipped a complete 1-kw UHF station across the continent.

The set-up includes everything a station needs to put a UHF signal on the air: a 1-kw UHF transmitter, a UHF Pylon antenna, complete control-room equipment, film projection facilities, cameras, microphones, turntables, and all technical accessories.

Take advantage of this unusual opportunity to see the type of layout now operating in the nation's leading UHF stations—like KPTV, WFPG-TV, WSBT-TV, WSBA-TV, WBRE-TV, WKBN-TV, WJTV, WKST-TV, WEMJ-TV, WROV-TV, WKNB-TV, and WHP-TV. And make sure you see all the other RCA equipment—like the RCA 10-kw transmitter for VHF, RCA's Tape Recorder, RCA's Audio equipment, RCA's new 5-kw AM transmitter, to mention just a few.

Come in and operate the equipment yourself. Plan and work out TV layouts with RCA's miniature models. Talk over your plans with your RCA Broadcast Sales Representative—and ask all the questions you want.

*The place: The Renaissance Room, Biltmore Hotel, Los Angeles.*



**RADIO CORPORATION of AMERICA**  
ENGINEERING PRODUCTS DEPARTMENT  
CAMDEN, N. J.

EVERY TECHNICAL ACCESSORY FOR A UHF TRANSMITTER PLANT

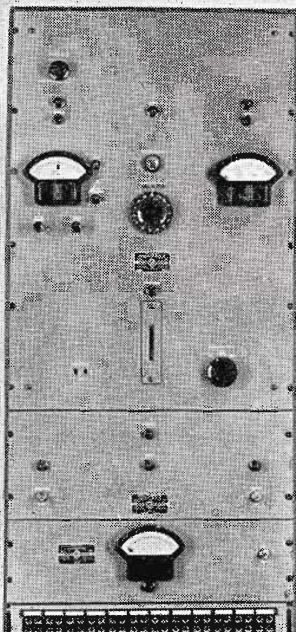

UHF Frequency and Modulation Monitors

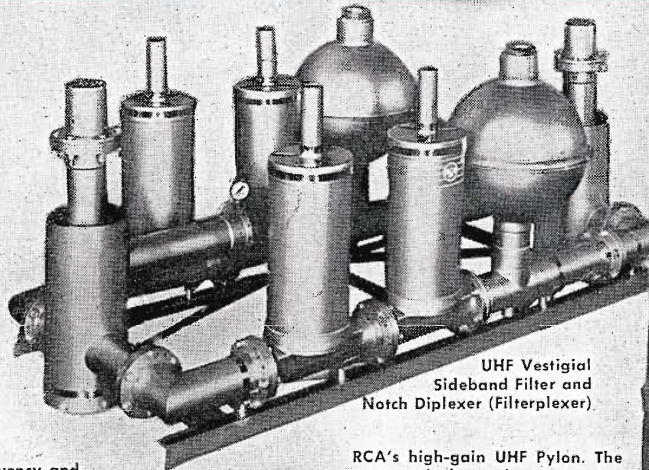

UHF Vestigial Sideband Filter and Notch Diplexer (Filterplexer)

RCA's high-gain UHF Pylon. The most economical way known to produce high ERP.

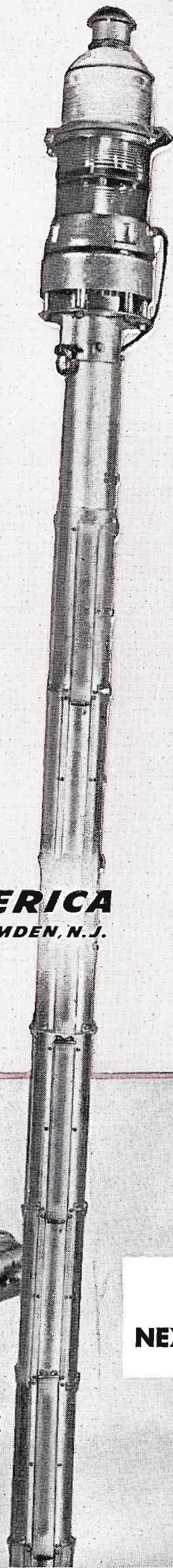

SEE  
NEXT PAGE

# SEE YOUR NEAREST RCA BROADCAST

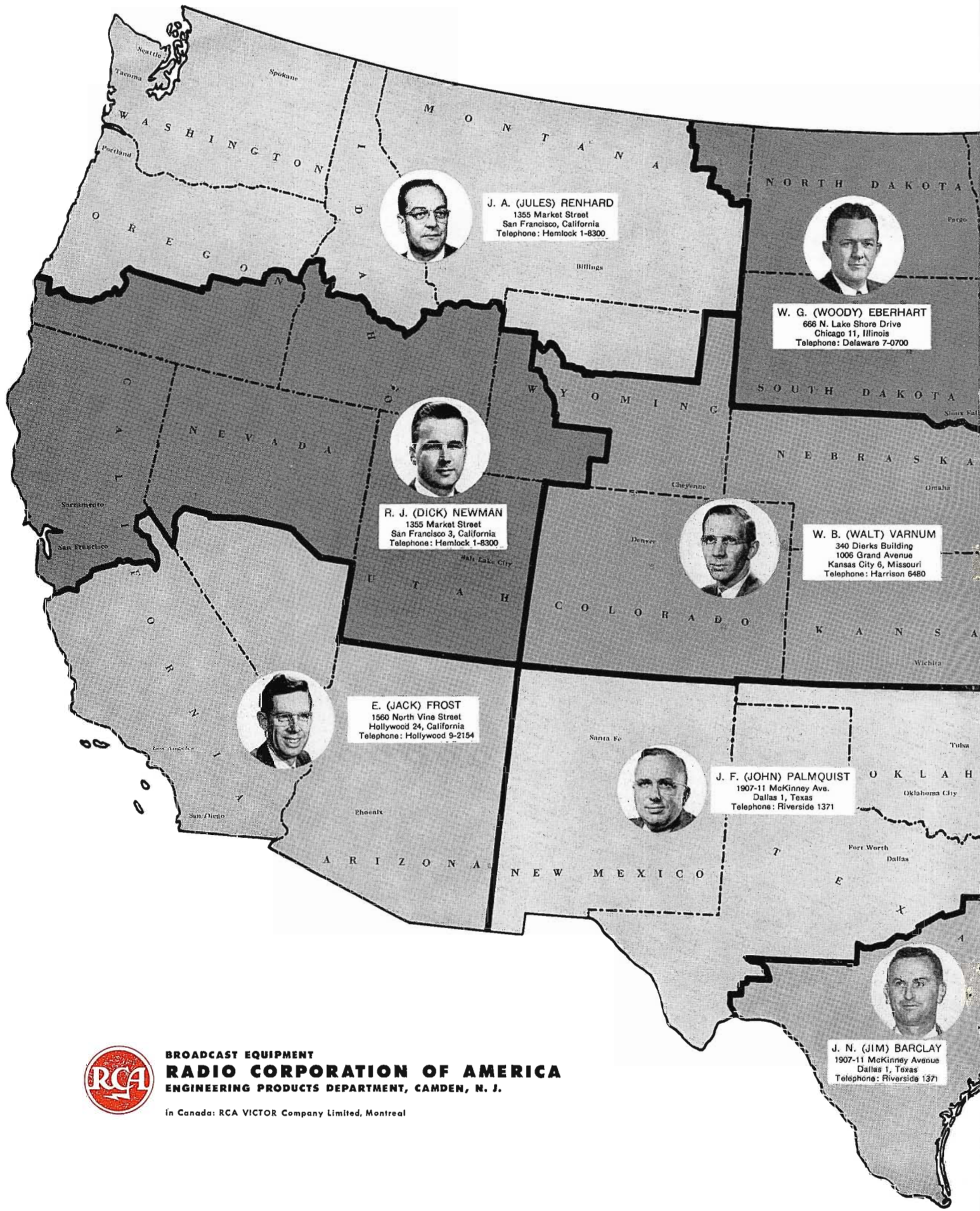

**J. A. (JULES) RENHARD**  
 1355 Market Street  
 San Francisco, California  
 Telephone: Hemlock 1-8300



**W. G. (WOODY) EBERHART**  
 666 N. Lake Shore Drive  
 Chicago 11, Illinois  
 Telephone: Delaware 7-0700



**R. J. (DICK) NEWMAN**  
 1355 Market Street  
 San Francisco 3, California  
 Telephone: Hemlock 1-8300



**W. B. (WALT) VARNUM**  
 340 Dierks Building  
 1006 Grand Avenue  
 Kansas City 6, Missouri  
 Telephone: Harrison 6480



**E. (JACK) FROST**  
 1560 North Vine Street  
 Hollywood 24, California  
 Telephone: Hollywood 9-2154



**J. F. (JOHN) PALMQUIST**  
 1907-11 McKinney Ave.  
 Dallas 1, Texas  
 Telephone: Riverside 1371



**J. N. (JIM) BARCLAY**  
 1907-11 McKinney Avenue  
 Dallas 1, Texas  
 Telephone: Riverside 1371



**BROADCAST EQUIPMENT**  
**RADIO CORPORATION OF AMERICA**  
**ENGINEERING PRODUCTS DEPARTMENT, CAMDEN, N. J.**

In Canada: RCA VICTOR Company Limited, Montreal

# REPRESENTATIVE FOR EQUIPMENT PLANS

**J. H. (JIM) KEACHIE**  
718 Keith Building  
Cleveland 15, Ohio  
Telephone: Cherry 1-3450

**J. R. (JOE) SIMS**  
36 West 49th Street  
New York 20, New York  
Telephone: Circle 6-4030

**R. S. (BOB) EMCH**  
718 Keith Building  
Cleveland 15, Ohio  
Telephone: Cherry 1-3450

**D. S. (DAVE) NEWBORG**  
718 Keith Building  
Cleveland 15, Ohio  
Telephone: Cherry 1-3450

**J. L. (JESS) NICKELS**  
666 N. Lake Shore Drive  
Chicago 11, Illinois  
Telephone: Delaware 7-0700

**J. E. (ED) HILL**  
John Hancock Building  
200 Berkeley Street  
Boston 16, Mass.  
Telephone: Hubbard 2-1700

**A. (AL) JOSEPHSEN**  
36 W. 49th Street  
New York 20, New York  
Telephone: Circle 5-4030

**E. S. (ED) CLAMMER**  
Front and Cooper Streets  
Camden, N. J.  
Telephone: Woodlawn 3-8000

**J. F. (FRANK) INGELS**  
340 Dierks Building  
1006 Grand Ave.  
Kansas City 6, Missouri  
Telephone: Harrison 6480

**A. M. (ADRON) MILLER**  
666 N. Lake Shore Drive  
Chicago 11, Illinois  
Telephone: Delaware 7-0700

**D. (DAVE) BAIN**  
1625 "K" Street, N. W.  
Washington, D. C.  
Telephone: District 7-1260

**W. D. (WILEY) WENGER**  
1907-11 McKinney Avenue  
Dallas 1, Texas  
Telephone: Riverside 1371

**P. G. (PG) WALTERS**  
522-533 Forsyth Building  
Atlanta 3, Georgia  
Telephone: Walnut 5948

**P. (PAUL) BERGQUIST**  
1625 "K" Street, N. W.  
Washington, D. C.  
Telephone: District 7-1260

**J. W. (JOHN) HILLEGAS**  
522-533 Forsyth Building  
Atlanta 3, Ga.  
Telephone: Walnut 5948

**J. M. (JOE) WALTERS**  
522-533 Forsyth Building  
Atlanta 3, Georgia  
Telephone: Walnut 5948

# WFPG-TV ATLANTIC CITY, N. J.

## UHF CHANNEL 46

**WFPG-TV**, South Jersey's first television station—went on the air December 21, 1952, at the "World's Finest Playground," Atlantic City, New Jersey—the first to operate with a commercial UHF transmitter (RCA 1-KW).

The venture was one of pioneering for several reasons: There was no previous background of operating experience with commercially-built UHF television transmitters. Nevertheless, our early transmitter problems were quickly brought under control once all technical and engineering adjustments were completed. Naturally, the eyes of many were focused upon WFPG-TV since it was a "pioneer" station.

Our potential audience in Atlantic City had earlier invested generously in VHF receivers and super de luxe antenna systems in order to receive barely perceptible pictures from distant metropolitan areas. Local dealers and nearby distributors with inventories of VHF receivers and very few UHF receivers were not prone at first to give UHF its deserved measure of enthusiasm. In looking back, we now realize that the VHF receiver owners and dealers were not thoroughly educated in advance as to exactly what they should do to properly "pick-up" WFPG-TV's UHF signal. The question of what kind of an antenna to use and how to orient the antenna should be completely answered ahead of time in all UHF markets. UHF television, as such, is an exact science and it has already been proved by RCA through several years of successful transmission at Bridgeport, Connecticut and at KPTV, Portland, Oregon. However, UHF requires that certain types of antenna equipment be used to obtain the finest results. Such antenna equipment is, in many cases, simpler and

by **FRED WEBER**  
President of WFPG-TV

and **BLAIR THRON**  
Vice-President and Director of Operations

less expensive than some complex, high-gain VHF antennas.

It is not costly to convert an existing VHF receiver and the small expense of doing so is amply repaid by entertainment value that heretofore was impossible to attain. WFPG-TV's audience was quick to recognize this as soon as the facts were known.

That high-quality pictures could be received by proper receiver installations was fully substantiated by measurements taken in the Atlantic City area. Such field strength measurements showed that in the city's business section, signal levels range from 7800 to 16,000 microvolts per meter with a 30-foot high antenna—well above the 2000 microvolt per meter signal level needed for snow-free pictures and also above the FCC estimated 5000 microvolt per meter signal strength required for Grade "A" coverage. Proof of high-quality pictures can be seen day-after-day in the local stores. Where good installations have

FIG. 1. Blair Thron, Vice-President and Director of Operations WFPG-TV, adjust cavity in visual section of the RCA TTU-1B UHF transmitter.

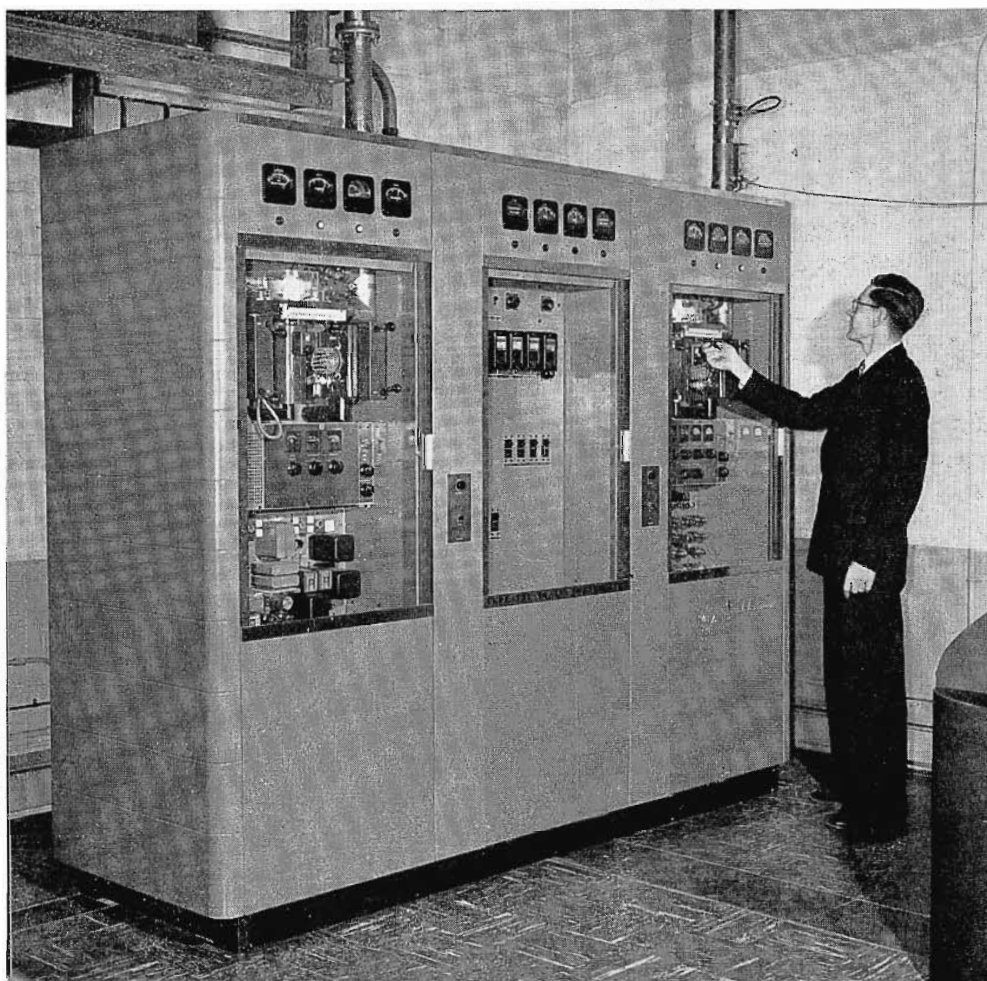



FIG. 2. Floor plan of WFG-TV transmitter building showing the complete layout of television facilities.

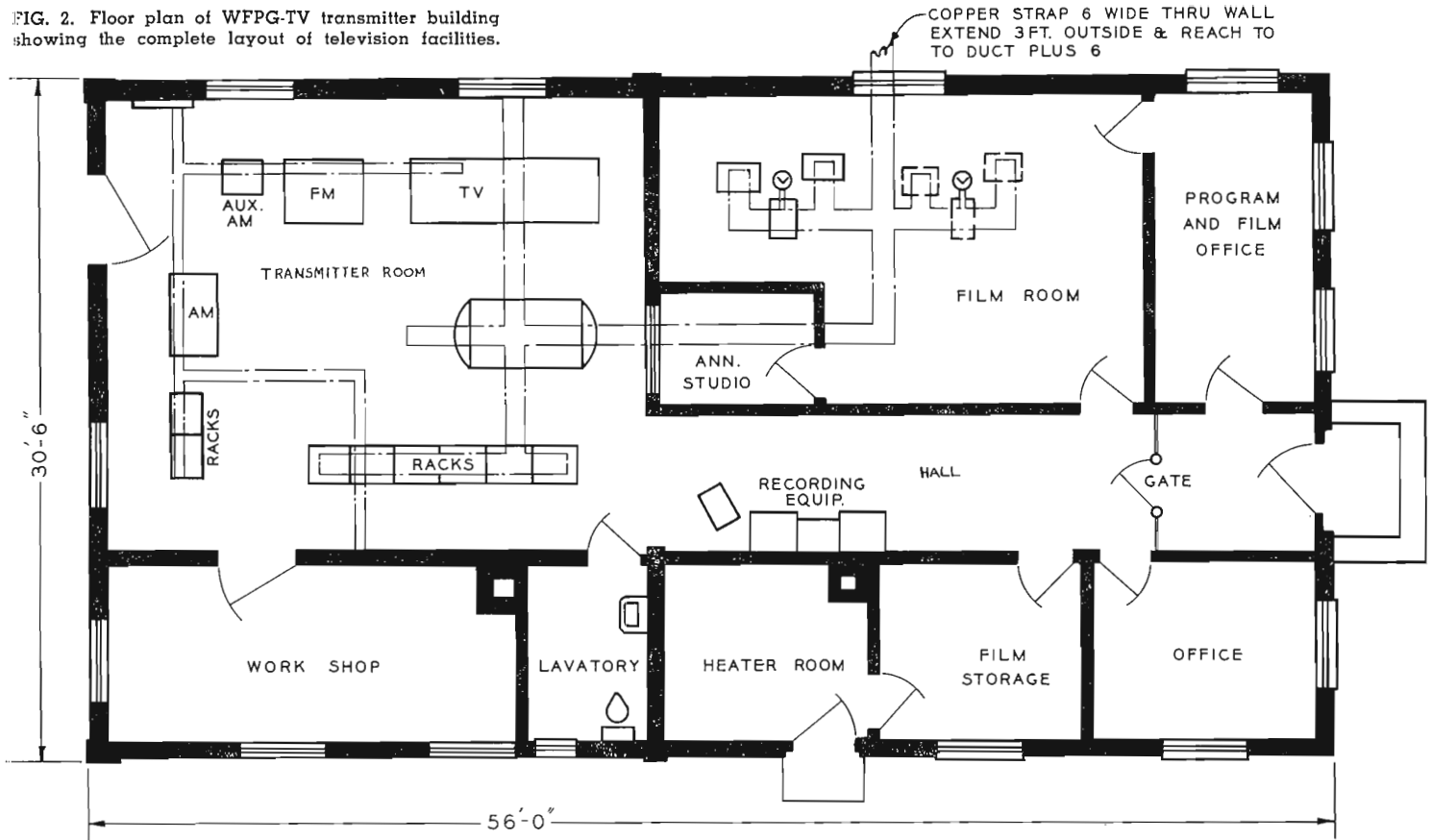
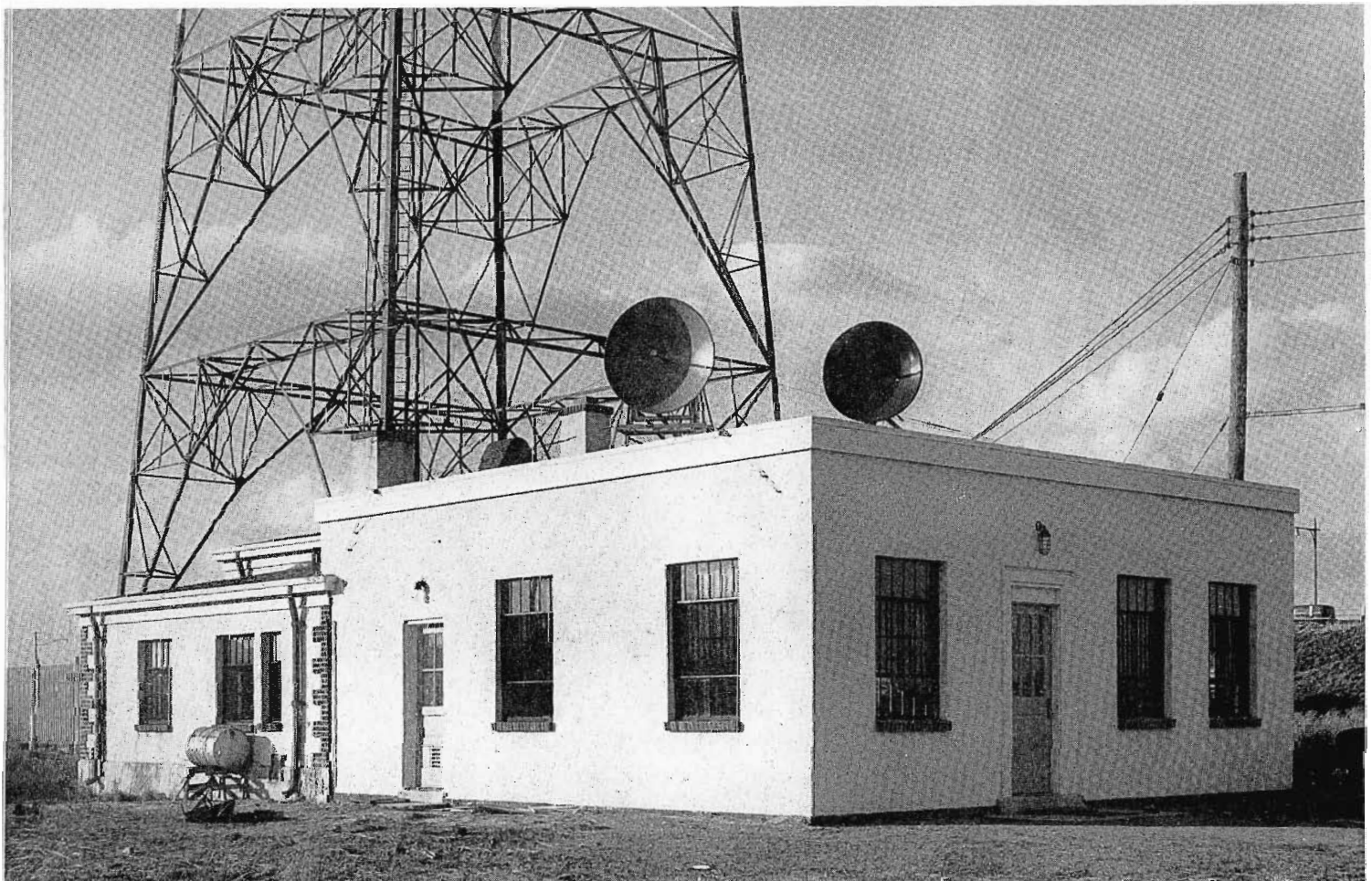

FIG. 3. Exterior view of the transmitter building showing tower in background and parabolic "dish" receiving antennas. Dish on left is telephone company microwave relay for network programs and the one on right is for TV microwave relay.



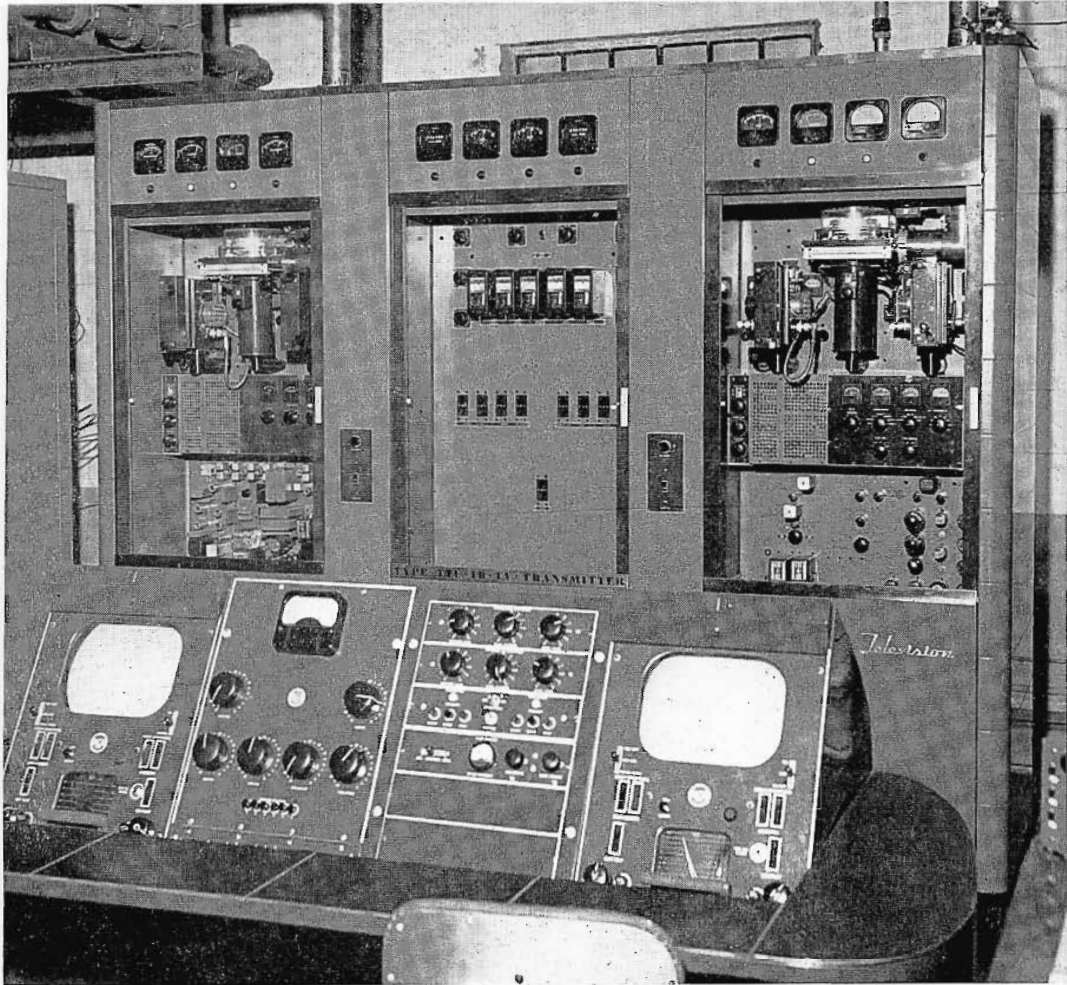

FIG. 4. Closeup of the RCA TTU-1B UHF television transmitter and TC-4A "Basic Buy" console—two excellent performers for UHF television broadcasting.

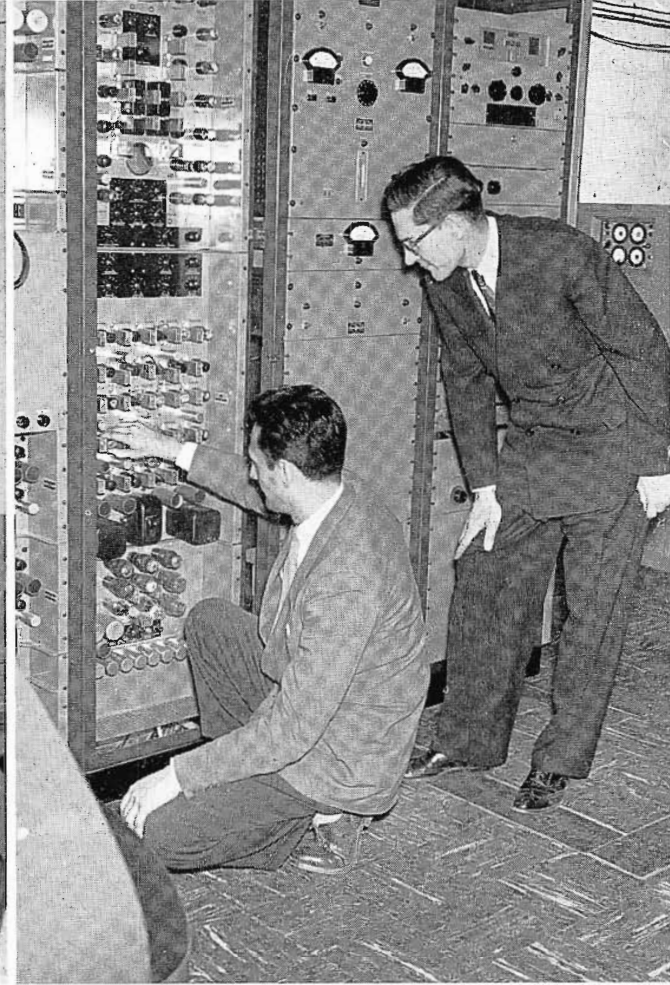

FIG. 5. Blair Thron, right, and R. C. Bare, Station Engineer, inspect RCA rack equipment.

been made, owners of older VHF receivers and newer UHF sets are enjoying better television than ever before. WFPG-TV has urged present-set owners and non-set owners alike to check with local dealers, distributors and manufacturers for intelligent and helpful answers to their questions.

WFPG-TV's programming is supplied from all four major networks—NBC, CBS, ABC, and Du Mont. WFPG's southern New Jersey station covers a four-county area in Atlantic, Cape May, Ocean and Cumberland Counties. WFPG-TV has now proved that the population of Atlantic City and surrounding areas will be served by one of television's finest UHF stations, and with "more-than-adequate" signal strength.

#### Description of Installation

Our construction permit was granted October 30, 1952 and just 52 days later at 8:15 P.M. WFPG-TV had test pattern and sound on the air.

At 8:00 o'clock on the morning of our grant, our construction began. This included a cinder block and concrete addition

to our original AM-FM plant, rearrangement of existing equipment to accommodate the TV gear, installation of wire ducts in the old concrete floor of the original building, increased power load requirements, and, of course, the complete installation of the TTU-1B transmitter, TC-4A console, TK-20C film camera, two TP-16D film projectors, automatic slide projector, and five racks of associated audio-video gear.

Our big problem was to rearrange our original plant to house the transmitter, console and racks. We had two reasons for this arrangement. First, our AM engineer would be available to take over some of the TV operating duties and second, installation of our more complex equipment could be accomplished while the addition to the building was under construction.

The new building houses the film room, with space for expansion, announcer studio, general office for programs and film handling, engineering office, film store room and heater room. A large hall was provided which also is used for our regular disc and tape recording facilities, moved from our old building.

Since our TV operation must necessarily be located at our present AM plant, considerable attention was given the probability of R-F interference. We completely shielded our film room with copper netting, soldered along all seams and carried to ground with a 6-inch copper strap. Very careful attention was given to proper grounding of wire shields at receiving ends, etc., lead was used for all a-c wiring, all wire was shielded, cotton braid, to eliminate "ground loops" as far as practical, but R-F was still present to some extent. Finally, special shields were installed around the input circuits and preamplifiers of the film camera, stabilizing amplifiers, monoscope, etc. Special attention was given to good ground connections to the various shields, covers and doors, ground straps used across hinges, etc. A-c power leads and B plus leads were filtered at "receiving" points. Little by little the R-F was reduced and now is virtually eliminated. The RCA Service Co. did excellent work on this problem, resulting in great improvement.

The problem of the filterplexer was solved by ceiling mounting. A movable sling of angle iron was used to hang the

unit allowing some slight alignment for the  $3\frac{1}{8}$ -inch coax line plumbing operation. Dry nitrogen at a pressure of 20 pounds from an automatic regulator is fed to the filterplexer. The unit itself has a set valve holding the pressure to a maximum of 15 pounds—the recommended pressure.

The line from the filterplexer to antenna is pressurized at 8 pounds by means of an automatic dry air pump. Our line incidentally is excellent, requiring the pump to operate approximately 5 minutes in 24 hours.

Since this was the first installation of a TFU-24B UHF antenna on an FM Pylon, a special pedestal had to be fabricated adapting the UHF antenna base to the Pylon top flange. In addition, a means of bringing out the line at the TV antenna base and down the outside of the FM Pylon had to be provided. The pedestal was provided with a slot in the side to permit entrance of the transmission line and made high enough to permit use of a 90° meter elbow to join with the antenna harness in the base of the TFU-24B. Two special 17-inch flanged sections of line were made up in advance to permit extension of the line horizontally beyond the Pylon flanges and back again to the tower center below the Pylon. In order to handle the line suspension on the Pylon, four 12-inch angle iron brackets were mounted on the Pylon flange bolts to support the spring hangers along the “back” of the Pylon.

Before setting the gin-pole and rigging, it was necessary to shunt feed our tower, since erection had to be accomplished without AM shut down and being a series feed base insulated tower, means had to be provided to permit the hoisting cables to cross base insulators. This worked out quite well with very little difficulty being experienced with our AM operation.

The TFU-24B antenna was lifted from the truck and placed on two specially built 8-foot high wooden horses upon arrival, to permit measurements to be made free of ground effects to make certain no damage had been done in transit. Before lifting, the antenna was fitted with its beacon and pedestal. A special section of 5-inch line was made up to adopt the teflon anchor in the

base to a 90° meter elbow—and these units were installed on the ground. A large loop of copper tubing was installed over the beacon and fastened to the beacon mounting bolts. A similar loop was used in the original beacon installation as a possible protection against lightning. Judging from the condition of the old loop it had apparently received many direct hits, but we had never suffered a damaged beacon or lost a lamp due to lightning, even though the tower had been struck heavily many times. The only difficulty in mounting the antenna was due to high winds on the morning it was planned to hoist, resulting in a delay until after lunch, when the wind eased off. When the antenna was finally at the top, it was found impossible to swing it vertical due to the step bolts digging into the gin pole and as darkness had fallen it was decided to lash it down in a horizontal position, resting on the Pylon top until the next morning. A guard was posted at the winch truck overnight to prevent tamper-

ing and, although fortunately the night was clear and calm, a rather uneasy few hours followed, especially for the men on duty at our regular AM operation, some 400 feet below and directly beneath the suspended TFU-24B. However, the next morning the antenna was mounted without mishap and the transmission line installed without any particular problems.

Installation of the rack equipment, switching console and projection equipment went right along in the midst of the builders, dodging flying chunks of concrete as the floor was broken up for the new ducts and trying to keep plaster and cement dust out of the equipment plus sand blown in through temporary barricades, where a wall was torn out. Since a definite on air date had been determined, no time could be wasted—and none was. As soon as a roof was on and glass in the windows of the new building, the film equipment was set up with the exception of the projector heads. These were kept cased

FIG. 6. The RCA “Filterplexer” (combination sideband filter and constant-impedance notch diplexer) is shown mounted in special cradle slung from overhead girders.

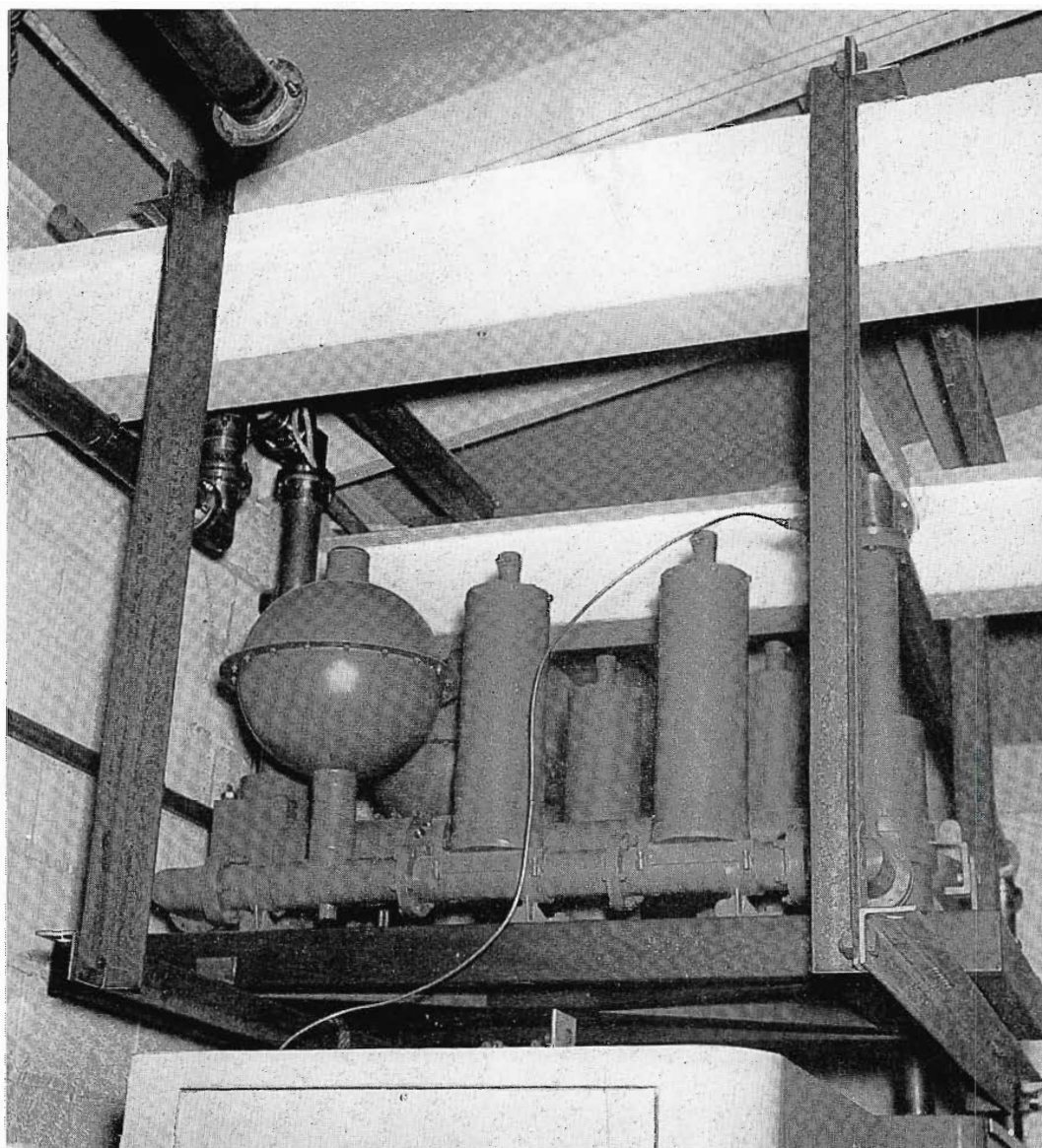

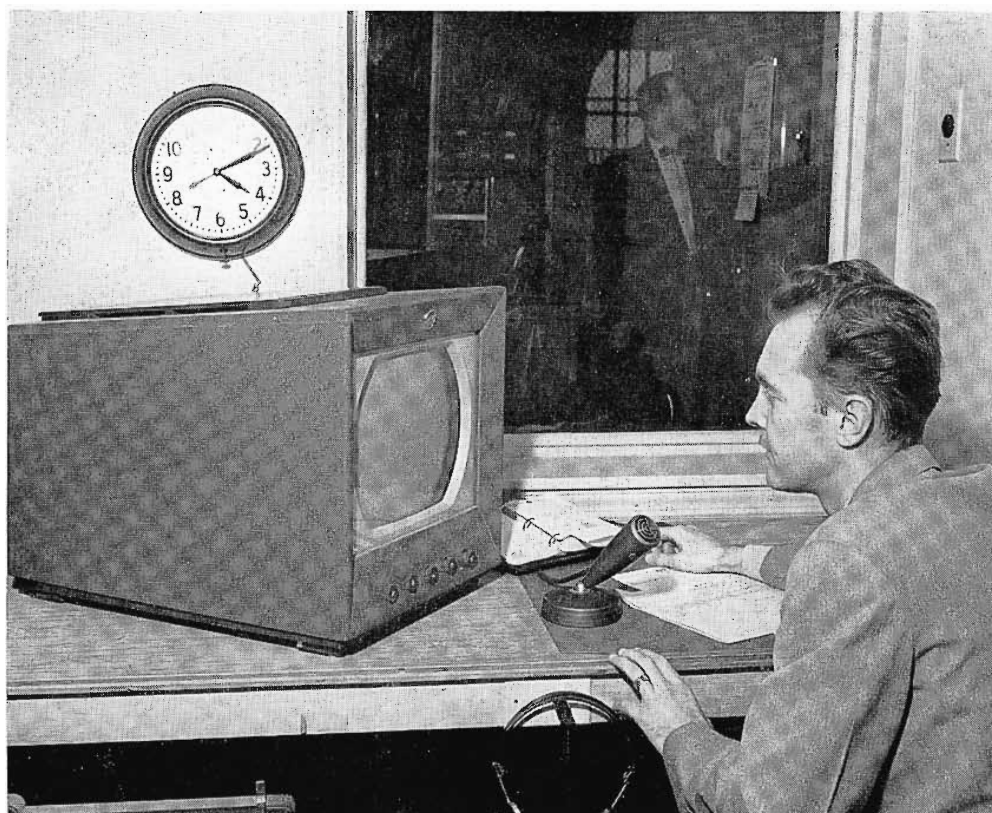

FIG. 7. Jim Burke, Station Announcer, sits before the RCA BK-1A "Commentator" microphone and the TM-2B utility monitor. See floor plan Fig. 2, for location of announce studio.

FIG. 8. Brad P. Lippincott, Projectionist, is shown inserting 2 x 2 slides in rotary slide projector.



until the film room was finished and thoroughly cleaned.

The construction was in good shape by the time the filterplexer and transmitter arrived. A near catastrophe developed when we learned the filterplexer, which was already on its way from Camden, exceeded the dimensions of its base upon which we had planned, due to the spheres extending considerably beyond on each side.

A quick examination of our door dimensions indicated that we were in trouble. A crew was immediately turned loose on one of our metal sash windows in the transmitter room, the sash removed and the filterplexer lifted in on arrival.

The TTU-1B transmitter was the last piece of major equipment to arrive. Our transmitter was the first to go out of the doors at Camden and was brought the 55 miles by special truck with a State Police escort, arriving at approximately 6:00 P.M. Friday, December 19th. Everything was in readiness. A crew of movers stood by to unload the units and carry them in, all wiring was run to the transmitter location. RCA Service Co. engineers Duncan, McKenna and Tom Dearing were at hand to supervise the installation and tune up. Early Saturday morning the line plumbing to the filterplexer was completed and the transmitter was ready to fire up.

The RCA Transmitter Section and Service Co. worked around the clock with our own personnel. Finally, at 8:15 P.M. Sunday, December 21st—just 52 days after commencement of construction, WFPG-TV went on the air with visual test pattern and aural tone. At 10:45 P.M. the same evening, a one hour commercial film was run, with regular programming including shows from all four TV networks, NBC, CBS, ABC and DuMont, scheduled to begin the following day.

After only three months of operation WFPG-TV is on the air 91 hours a week, including 58 hours of programming of which  $37\frac{1}{4}$  hours are NBC and CBS—and 33 hours of test-pattern. Only  $1\frac{1}{2}$  hours nightly after 7:30 P. M. remain unfilled by network programming. Full daytime as well as night-time programming is planned, beginning in May, including a complete baseball schedule. We are affiliated with all four networks, our primary affiliation being NBC. Network service involves five microwave "hops" from Phila-



Fig. 9. View of Flange Pedestal Adapter used to mount the UHF Pylon antenna atop the FM Pylon. Wedge-shaped extensions are vent louvers.

delphia, making the temporary use of State fire towers and the Ritz Hotel here in Atlantic City.

Real credit is due all those involved. Space does not permit individual mention of all concerned, but we certainly must express appreciation to those who worked around the clock and did such a fine job. Especially to our own crew, Earle Godfrey, plant supervisor, Jim Lafferty and Joe Roberts of our TV staff, and Brad Lippincott, our projectionist—to Radio Towers Co. who handled the erection of the antenna—to J. Vaughn Mathis, architects and builders, for their cooperation in supplying us with a building in record time and last, but far from least, the many people at RCA in the Sales, Engineering and Service groups, who kept equipment and parts rolling in, supplied information and advice wherever possible, gave up lots of sleep and even their Thanksgiving turkey to help WFPG-TV make good its promised "on-air" date.

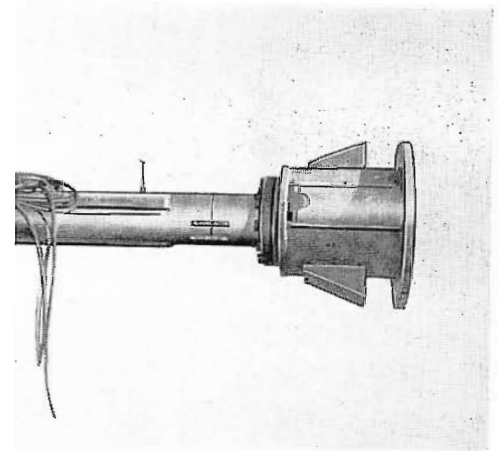
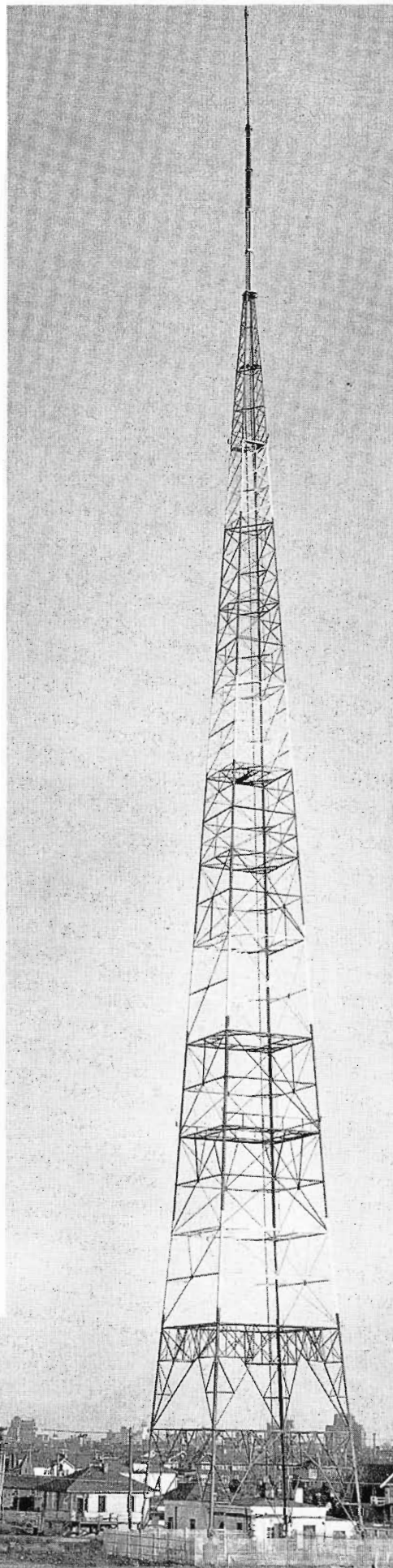

FIG. 10. Side view of Flange Pedestal Adapter fastened to base of UHF Pylon. Note hole in adapter near antenna base through which transmission line passes.

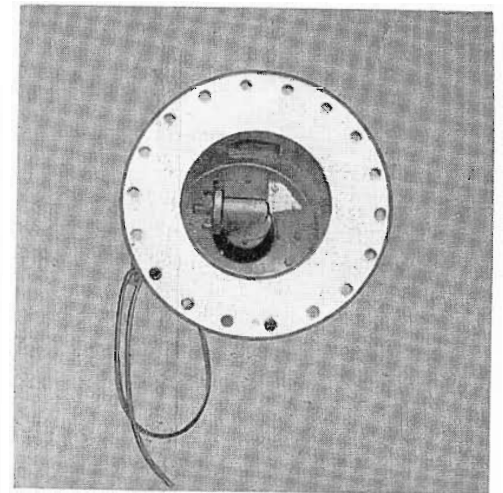
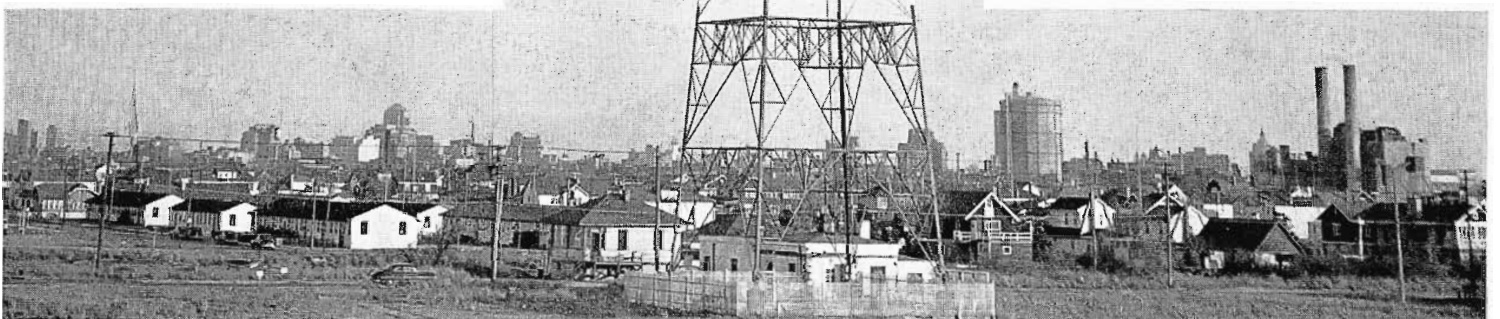

FIG. 11. Lower-end view of Flange Pedestal Adapter showing mitre-elbow in position for connecting with external transmission line.

FIG. 12. Overall view of WFPG-TV tower and UHF antenna with Atlantic City skyline in the background.



# WBRE COMPLETES A UHF TELEVISION INSTALLATION

by **DAVID M. BALTIMORE**  
Manager, WBRE-TV

On October 1, 1952, the construction permit to build WBRE-TV was received. On December 28, 1952, at 11:58 P.M. the first test pattern was put on the air. The picture was nearly perfect. Into those ninety days, however, went the most concentrated effort by a group of people ever attempted in the northeastern Pennsylvania region. After discussions with RCA equipment people, a goal was set which was shortly finalized, and January 1, 1953 was made the target date. WBRE-TV took up the challenge, and determined to make it. Under the leadership of Lou Baltimore, veteran broadcaster of 28 years, his son, David, and with the expert guidance of one of the keenest minds in engineering, Charles Sakoski, Sr., Chief Engineer of WBRE AM and FM, plans were soon turned into concrete, plaster, and electronic wonderments. The planning of WBRE-TV went back seven years to February 1946 when the first application for TV was filed with the FCC, and to October 1946 when the first contract was signed with RCA for equipment. Through those seven years, the contracts were revised and brought up-to-date at least a dozen times, and the plans for the station equipment and operation were changed with them. The planning of those years paid off, obviously, because the station was built, checked, and put on the air ninety days later.

Early in 1947 when WBRE-FM was constructed, all plans were made with TV in mind. Even though at that time UHF was not dreamed of, many of the operations of that period turned out well for UHF operation. For instance, the FM building was built to accommodate a TV transmitter so that one construction job could be done without having to disrupt operations later in order to expand. The space having been provided in advance, all the time normally necessary for such building was saved after the CP was finally granted years later. When the FM tower was selected, it was made twice as

high as needed for FM in order to obtain all the height thought necessary at that time for "line-of-sight" VHF signals. The tower was also made strong enough to handle two antennas. Since that time, however, subsequent antenna design changes have made it necessary to change FM antenna installations and characteristics somewhat in order to accommodate the TV Pylon. A four-legged, self-supporting tower was installed in 1947 at considerably less expense than the equivalent tower today. This probably was the most foresighted investment made.

With tower and building construction already completed, the entire staff was able to devote all their energies to the obtaining and installation of equipment. Studios were modified only slightly in order to accommodate TV, and space in the building long unused was put into use with little more than painting. Having an old, large converted mansion as a base, this was not a real problem, and had been solved months earlier by meetings with engineering, program and management personnel. Franklin D. Coslett, operations director, Charles Sakoski, and David Baltimore were involved in this planning stage.

Equipment was received eagerly, piece by piece, installed, lined up and ready to go. Although a tremendous task, everything went extremely smooth, and proved that the long planning was not in vain. In fact, the months and months of preparation and expectation prepared the Chief and his boys quite thoroughly for the job which they pitched into and expedited.

Equipment came from RCA and the job of coordination of shipping was left up to Louis G. Baltimore, who handled it quite

**FIG. 1. 380-foot tower supports UHF antenna on top, FM antenna on side, and "Beam-Bender" dishes for deflecting studio microwave relay signal to ground. The relay receiver is located on the roof of the building where servicing is relatively simple in all weather.**





FIG. 2. Main room of TV transmitter building. Charles Sakoski, Sr., Chief Engineer, checks 1 KW RCA UHF transmitter, while Joe Emashowski, Jr. operates console. In the rear is 1 KW RCA FM transmitter. Room through door in rear is workshop and store-room.

well. He stayed on the job in Camden and elsewhere and nursed the equipment along until it was shipped. The antenna was the last large item to be received. It arrived only hours before the pattern was actually thrown on the air. The filterplexer was another major requirement. Two men left Christmas night to pick up this item in the company truck in order to be sure that shipping delays would not hold up the opening. After a two-day wait they returned home only to find other parts needed. Another over-night trip, this time to New York to meet a plane from New England. Up to the last minute, however, a man was usually being sent off to some place in Camden, Lancaster, or New Jersey to pick up one small "horseshoenaill" after another.

After a very long December 28th, during which day thousands of calls were answered informing an eager public that the transmitter's "test pattern" would be on "soon", the biggest thrill in the lives of the entire crew came when the pattern finally was "on-the-air"—the boys had "done it".

All the doubting Thomases who had money on our not making it were quickly rounded up and made to pay off. Weeks after, though, after an evening's viewing of excellent quality TV programs, we all still pinch ourselves and ask, "Is it really there . . . ?" It seemed so hard to believe after seven long years of waiting . . . and actually twenty-one years of dreaming. For it was in 1932 that Lou Baltimore made the first TV set in this area . . . an old disc scanner with a neon glow lamp and a six inch square ground glass screen. Mickey Mouse and Abe Lincoln were the only program fares in those days, but it marked the beginning of interest in TV by Lou Baltimore, David Baltimore, and Charlie Sakoski.

#### Studios—Design and Equipment

WBRE-TV has one Main Studio 20 feet by 30 feet. This studio was radio Studio B. It made an excellent start, and will be sufficient for most purposes for at least the first year or so. In addition to the Live Studio, another room, 14 feet by 17 feet is now being used for prop storage,

but is wired and planned as a kitchen set as soon as it can be converted and put into use. This was not hurried because the demands of filling the night time schedule were more important than the studio for an early afternoon show which couldn't be put on the air for some time. The TV Control Room was made using the FM control room as a base. It was enlarged to twice its original size and is a spacious, comfortable room housing monitors, switching, and complete studio rack mounted equipment. This room is about 15 feet wide by 30 feet long. It is partly air conditioned for summertime cooling. The Film Studio was located downstairs, immediately beneath the live studio. This room, long-used for storage, but completely finished off with plaster walls and terrazzo floor, became ideal for the purpose. One film camera, two film projectors, and one slide projector are currently in use. A second turret slide projector will be put into operation, multiplexed in with the other projectors, as soon as the demand warrants it. All this equipment can be remotely operated from the director's con-

FIG. 3 (top). Scene through control room window shows daily 6:30 news program under way. Horse on flat at rear of studio is backdrop for cowboy daily show.



FIG. 4 (center). Control room at studio houses field camera monitors, film and program monitors, off-the-air monitor, and racks for sync generator, monoscope, and allied equipment. High desk in rear will be switching position to be used by program director in controlling cameras and film on studio-produced shows.

FIG. 5 (bottom). Film projection room uses standard RCA equipment. Monitor in rear is used for film monitor and off-the-air monitor.



sole in the control room. The director is located on a raised platform and console, with a clear view of all monitors and the studio in one narrow viewing angle in front of him. To get back to the film room, all splicing, film storage and film record files are also in the same room, and it is a compact, efficient operating unit. In the Live Studio use is made daily of two field cameras. There are live shows all evening long. The first at 5:30, a cowboy show. Our local personality interviews children on their birthdays. They come all dressed in cowboy and cowgirl regalia, and some parents have driven their children 130 miles round trip to have them appear on the show. We have a 6:30 live news cast, a 6:50 live sports cast, a 7:15 strip of live shows including an excellently prepared fashion show which is sponsored. We have a forum at 9:00 on Monday, religious programs, story tellers, and college shows on Saturday and Sunday, and an 11:00 P.M. news cast each night of the week. As a result, our cameras are in use for many hours daily. The acceptance of most of the shows is quite good, and the preparation of local live shows is highly recommended.

#### Transmitter Facilities and Coverage

The transmitter site is also an excellent one. Located on a 2100 foot mountain, the 380 foot tower and 40 foot antenna provide a height above average terrain from two to ten miles of 1224 feet. This is most satisfactory because almost every community within thirty miles of the site is in line of sight.

A topographical map was used two summers ago to compute the profiles in all important areas and to shadow in all the areas behind obstructing hills. This shadow-





graph showed that most of Wilkes-Barre, except that part closest to the tower, was in the clear. All of the forty communities adjacent to Wilkes-Barre were also in line of sight. This includes Pittston, six miles north, and Nanticoke, six miles south. The map also shows that Scranton, about eighteen miles away, was almost all in line of sight, and one area, of minor proportions was shadowed from a few to much less than 100 feet. Going farther north, all communities right up to Carbondale were in the clear. Hazleton on the south was all in sight from the top of the tower, as was Berwick and Bloomsburg on the south. That this planning has been correct is shown by the reports which have come back, and by the results obtained. Actual reception which can be classed as class A is being reported from Danville, forty-eight miles to the south, along the river, to above Carbondale, which is over twenty-four miles north. Hazleton, too, has received excellent pictures. Actual reports of signals come from just south of Binghamton to Sunbury, to Allentown, to Reading. These are all documented by letters from people in these parts. WBRE-TV's radiated power at this time is, incidentally, about 18,000 watts. A CP has been issued for the full 1,000,000 watts, and this power is expected to be obtained in two additional steps. Sometime later in 1953,

the 10 KW RCA amplifier is expected to be delivered, and in 1954 the full one million watts is expected to be obtained from a 50 KW amplifier.

The transmitter building is 50 feet by 30 feet. It houses the RCA FM 1 KW transmitter as well as the RCA 1 KW TV transmitter. The filterplexer is mounted on a heavy table behind and to the side of the transmitter in order to be convenient for adjustment. Plenty of room has been left for the additional amplifiers and racks to be added so that when all is complete, the transmitters and racks will form a large U with about a 20 foot base and two 12 foot sides. The control console is located in the middle.

During the first few weeks of operation, some preliminary difficulties were experienced but were eventually licked. Eventually, a system for starting up and tuning the transmitter was evolved which seemed to cut down technical difficulties to a minimum. Extended tube life has been obtained as a result of this system. After the first sixteen days, and up to this moment of writing, not one second has been lost as a result of transmitter breakdown. Once again this attests to the ultimate quality of RCA equipment. Incidentally, all transmitters and equipment in the WBRE-AM, FM and TV operation are RCA.

A Beam Bender is now being used as a passive reflecting device on the antenna tower. In this manner, it has been possible to keep the receiving end of the microwave on the roof of the transmitter building, in a special housing, so that all active equipment can be serviced without climbing the tower in any bad weather. The penthouse on the transmitter building roof is accessible from inside the building, and maintenance is simple.

#### Network Affiliation

WBRE-TV is an NBC affiliate and carries CBS programs on an interim basis. Since no AT&T coaxial or microwave facilities are available to the Wilkes-Barre/Scranton area, WBRE-TV built its own intercity relay. The background work and planning for this was done immediately after the war when need for this service became evident. Actually, right at the transmitter site, a perfectly usable signal is available from WBNT and WCBS-TV, over 80 miles away. And from WPTZ and other New York and Philadelphia stations. A Rhombic receiving antenna, peaked to Channel 4, is erected on 65-foot telephone poles. This antenna brings in signals of amazingly high intensity. During the last six years of waiting, this system was used to demonstrate TV to clients, press and public. Early in 1947

FIG. 6. The housing on top of transmitter building holds the microwave relay receivers for studio transmitter link and inter-city relay link. Telephone poles in background hold Rhombic antenna for direct pickup of WBNT at 100 miles air line distance. Pictures are perfect over 90 percent of the time.

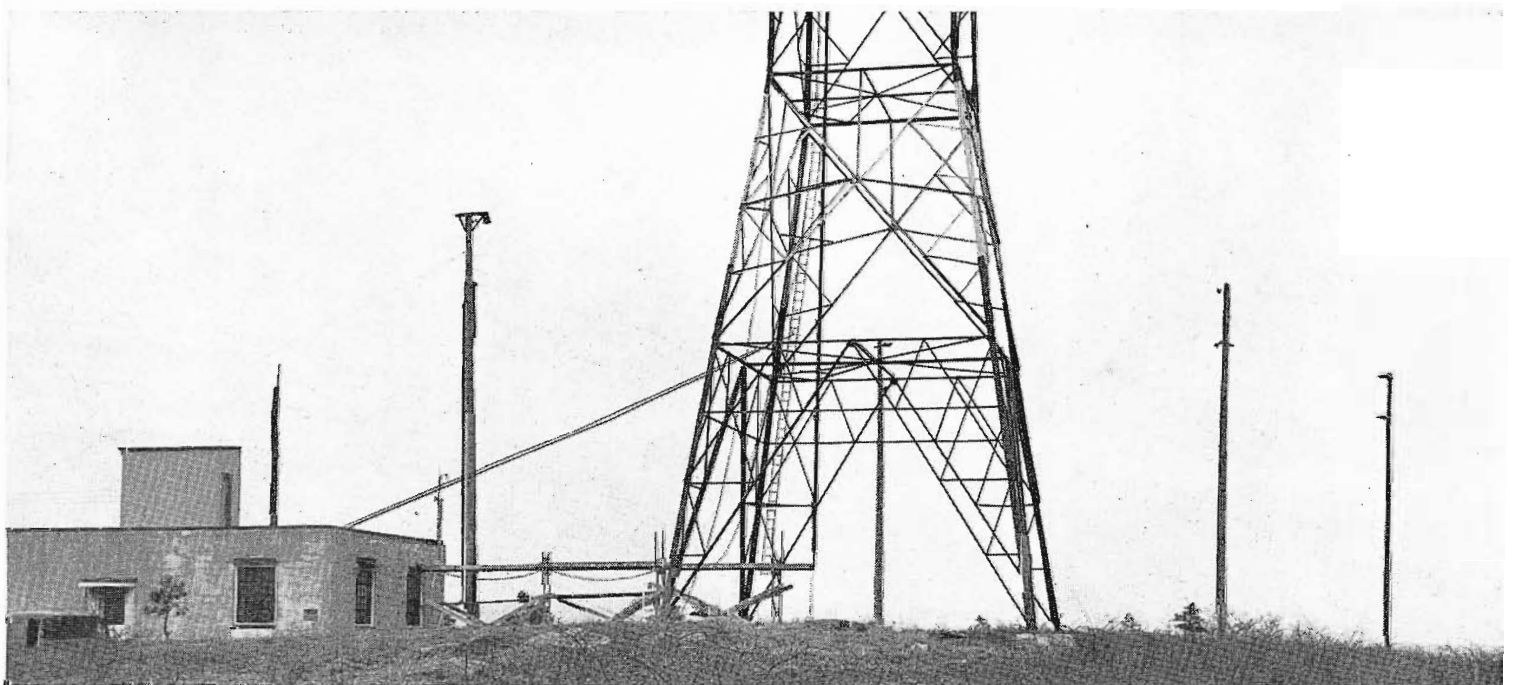

the Louis-Walcott fight was demonstrated to over 7000 people at an outdoor event, using RCA's first large screen TV projector receiver. Later, the signal was microwaved into town for Parade of Progress exhibitions, where public enthusiasm was raised to an extremely high degree. All of this experimentation and promotion was done to insure that when the need for network service arose, the service could be provided. To insure the signal continuity, a site was rented from the state at Pimple Hill on the Effort Mountain range. This high spot showed, after exhaustive test, that signals from New York and Philadelphia were strong and clear and free from noise almost 100 percent of the time. Another Rhombic antenna was erected here during November and December, and a microwave unit

was installed to beam the network signals back to the transmitter. This unit is semi-automatic, and is attended by a maintenance man who lives at the site. Station technicians also service it on a regular basis. The programming quality has been excellent, and there have been no interruptions of network service. Quality of picture is so perfect that there are few sets in New York which receive it as well. Since WBRE-TV operation has always been promoted in the "Dragnet" style—that is to underplay and under-rate the accomplishments, it is stated here that the above remark is also plausible.

#### Receiver Distribution and Public Acceptance

The remaining problem—that of set distribution—has been no problem, but a joy

to behold. Since this area has been a fringe area, all started by WBRE experiments, demonstrations and promotions as far back as 1947, reception from without has never been good, regular, or completely acceptable. Having been held from TV for so long, the public has been in just the right frame of mind to receive the new station with wild acclaim. Set sales have been good. In fact, as Codel's Digest reporter puts it, "terrific". All distributors who were alert and believed in WBRE's promises, were ready when the test pattern went on. They had sets and they sold them as fast as they could. In a market area where, with 18,000 watts, the coverage encompasses 860,000 people and 244,000 homes, approximately 40,000 sets have been converted or sold. It has been estimated that there are 40,000 VHF sets in the same area. Based on conversion of a large number of these, plus sales of new sets, the claim of 40,000 Channel 28 tuned sets seems quite reasonable. The potential of the market for the first year is estimated at 120,000. As Codel's Digest pointed out, the rooftops have sprouted a new maize of bow ties. In some areas there is 100 percent conversion from Channel 12 fringe reception to Channel 28 local. And even the rooftops don't tell all the story. Because there is no bow tie, or because there is no antenna at all on a roof, there is no reason to assume there is no TV in the home. So many sets are working with built-in antennas, with "rabbit ears", or with bow ties on the window sill, that the roofs don't tell even half the story.

Dealer after dealer proclaims the wonderful reception obtained with built-in, or indoor antennas. The writer is one of these, with a bow tie ensconced on the window sill, leaning against the steel bars of the casement window.

Perhaps the biggest problem of all was in New York and Chicago, and not in Wilkes-Barre at all. With the 24th largest market in the nation to serve, Wilkes-Barre-Hazleton-Scranton, the problem was to convince the advertiser and his agency that UHF was here to stay. Pointing out that several hundred broadcasters about to embark on UHF-TV with an expenditure exceeding 3,000,000 dollars could not be all off on the wrong course at once and together, seemed to convince a lot of ad-



FIG. 7. Relay transmitter housing at Pimple Hill on Effort Mountain. This point is approximately 70 miles from New York and is used as main inter-city relay connection.

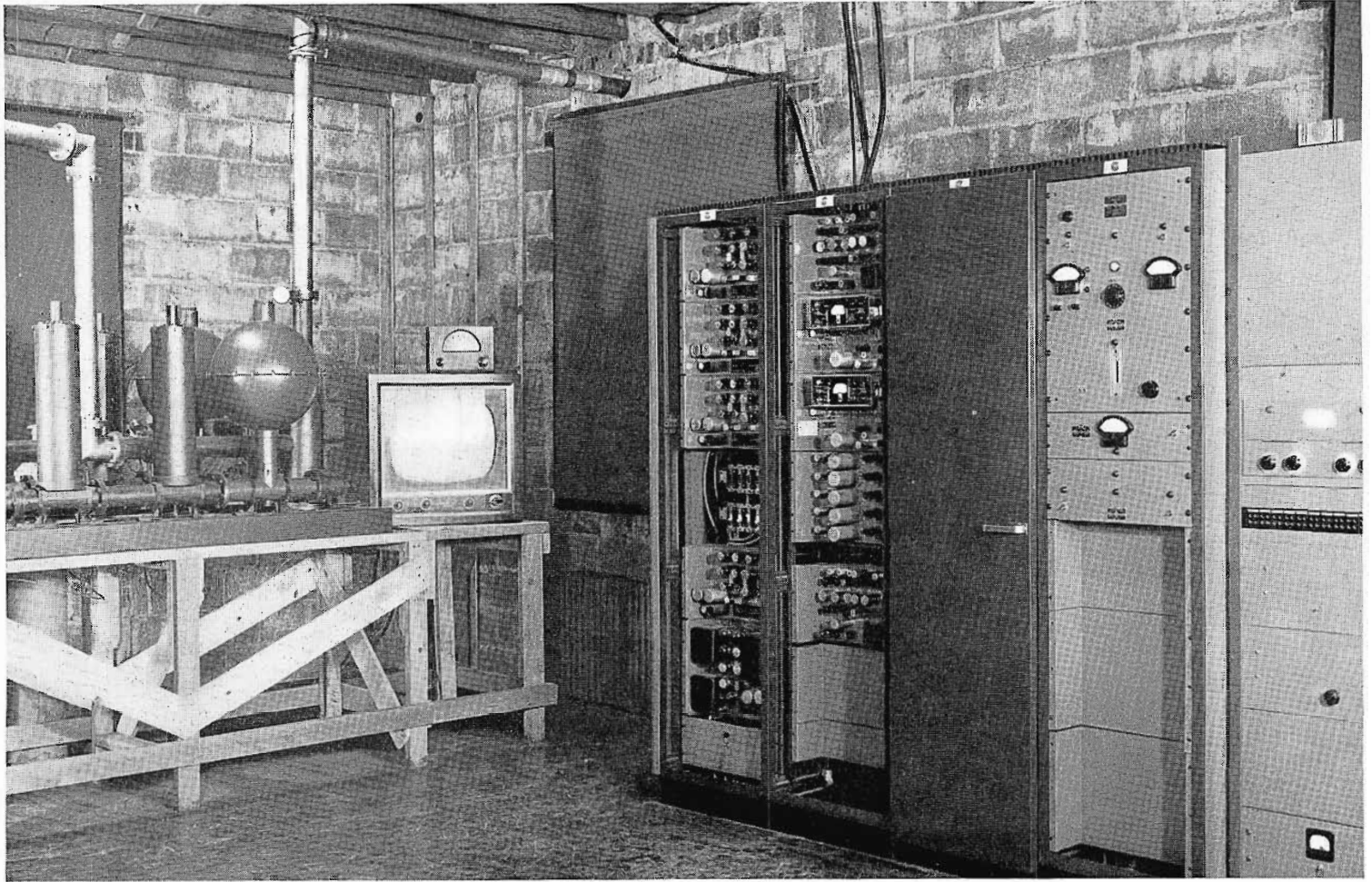
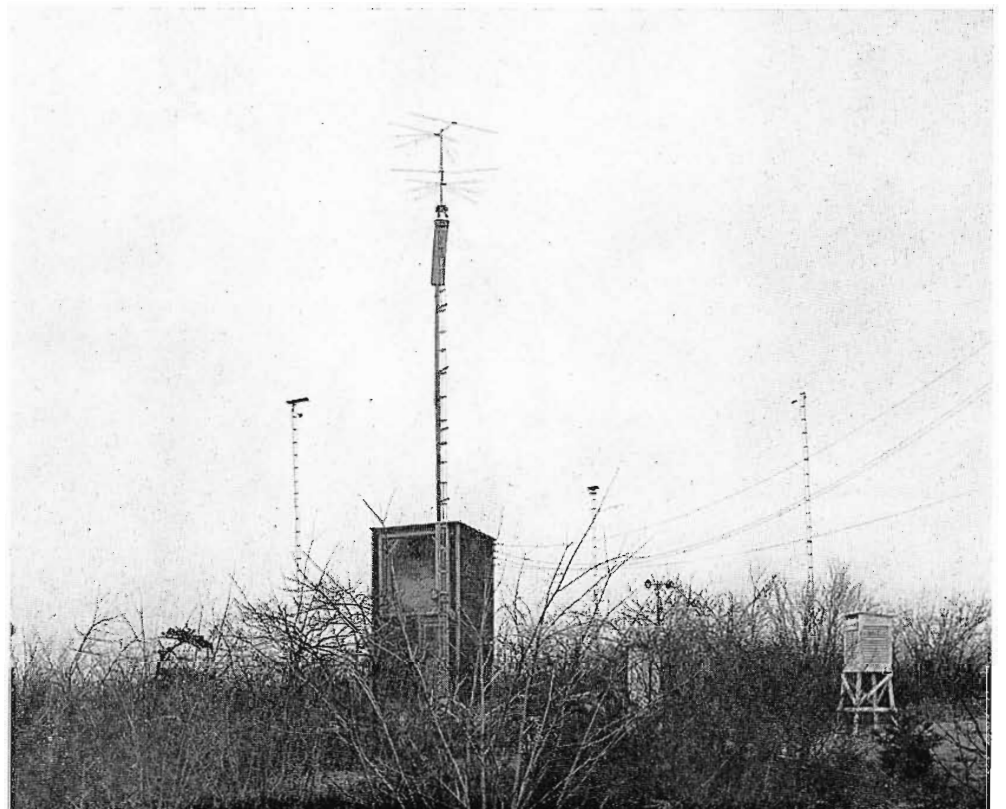

FIG. 8. Remainder of TV transmitter room showing filterplexer conveniently mounted on table for servicing. Racks at right hold power supplies, relay receiver controls, monitoring equipment, and audio equipment. TV receiver is for direct pickup of WNBC, New York, as standby network service.

vertisers of our faith in UHF. These advertisers have been given every bit of final justification for that faith. As a result, the entire night-time schedule between 7:30 and 10:30 P.M. plus some additional periods, have been contracted for by the advertisers in network TV. Spot sales have been astounding. For after only a few weeks of operation, the majority of availabilities are gone. As a result, the daytime schedule has been opened up, and the 5:30-11:05 schedule is now expanded to 3:00-11:05 Monday through Friday, 4:30 to 11:05 Saturday, and 1:00 P.M. to 11:05 on Sunday. As soon as possible, the schedule will be even further expanded into earlier hours.

Yes, RCA's UHF works wonders in Wilkes-Barre/Scranton. The people like it, and it's here to stay!

FIG. 9. Over-all view of Pimple Hill receiving point showing Rhombic antenna for WNBC and auxiliary antennas for Philadelphia. Site is also weather observation point for State Conservation Project.



# WSBA-TV YORK, PENNSYLVANIA UHF CHANNEL 43

Pennsylvania's first UHF television station went on the air December 21, 1952 to provide one of America's fastest-growing markets with the finest television reception and programming. WSBA-TV serves a population of over 800,000 in the area of York, Harrisburg and Lancaster, Pennsylvania, covering a radius of from 30 to 40 miles. Here, new industries are taking root—and many have been established for years—to provide a buying income of close to \$1,300,000,000.

by **PHILLIP K. EBERLY**  
Commercial Manager

As an American Broadcasting Company affiliate, WSBA-TV programming consists largely of films, and network which is received by East-West AT&T Microwave Link from Hallam, Pa. Fourteen or fifteen films are run each week—some as long as one- and one-and-a-half hours in length. Live shows at present consist of news and sportscasts.

The enthusiasm of the York area televiewers has been widely demonstrated by the great number who have converted their existing VHF receivers to receive Channel 43, and the number of new UHF receivers sold in the area.

## Local Community "Home-Type" Programming

In the York area, programming of the Local Community, "Home-type" seems to be appreciated. Local programs of a "How-

FIG. 1. The RCA TTU-1B 1-KW UHF Transmitter is flanked by equipment racks. The filterplexer is mounted just above the transmitter. In the foreground is the TC-4A Audio/Video console and field switcher and monitors.

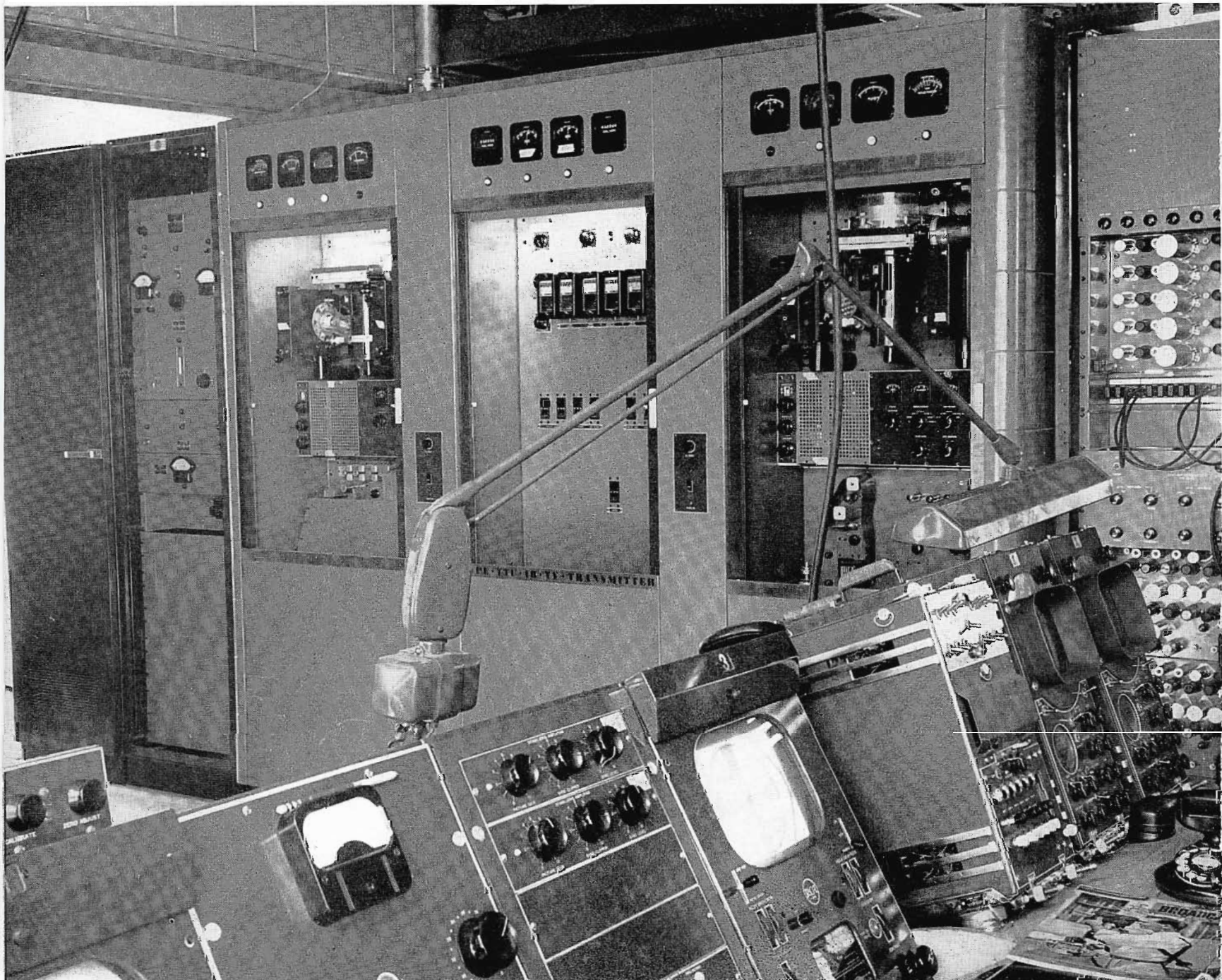

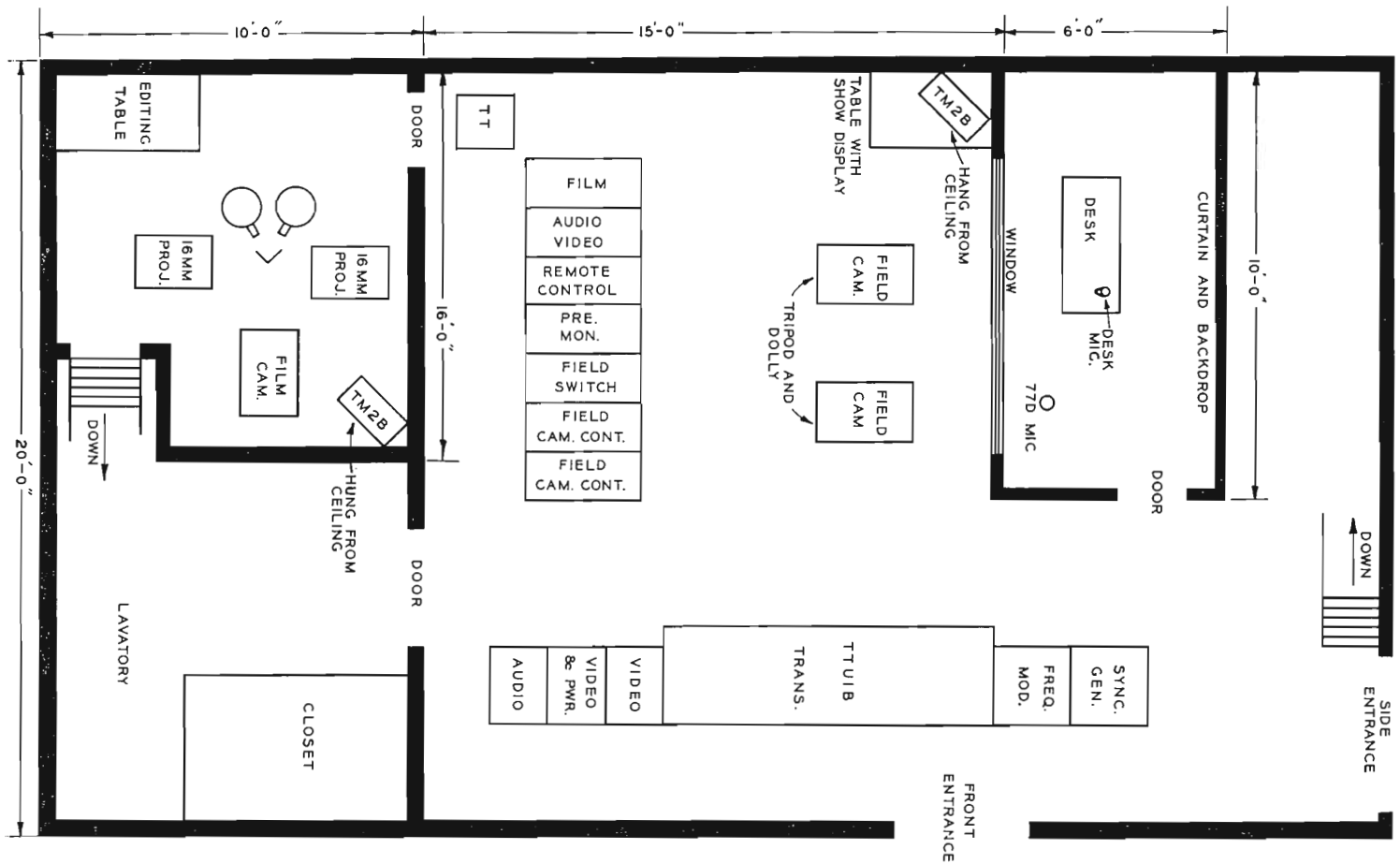

FIG. 2. Floor plan showing transmitter layout of WSBA-TV facilities.

to-do-it" variety are planned to provide helpful and educational hints for the home, garden, farm, etc. A certain civic pride is taken in the historic background of York and surrounding communities. York is the home of the first Continental Congress. Gettysburg, Pa., which is about 38 miles from York, each year re-enacts the scene of Lincoln's Address and much history surrounds the famous Susquehanna River and the Susquehanna trail. The area is famous for the historical Conestoga Wagons. It is planned in the future to record these events on film, narrate and program them.

#### Antenna and Transmitter Installation

The entire installation was supervised by Llewellyn Jones, Chief Engineer of WSBA. Along with WSBA's staff, the RCA and RCA Service Company Engineers worked "around the clock" to put WSBA-TV on the air in approximately sixty-five days. The antenna installation consists of a Truscon self-supporting tower and an 18-Section RCA TFSU-24BM Antenna fed by RCA 3 1/8-inch Teflon UHF transmission line. The antenna has been adjusted to provide 1.1° electrical beam tilt.

#### The Transmitter Building

A transmitter building of brick construction, 36 x 20 feet, houses the complete

TV facilities. Entering the side entrance, a "down" staircase leads to offices located at the basement level. Entering the transmitter room, you pass the transmitter and rack equipment. To the right is an announce studio, 10 x 6 feet, which includes a curtain backdrop, a desk, and a broad window through which two RCA TK-31A Field Cameras shoot "live" programs. Audio equipment at the transmitter includes an RCA BK-1A "Commentator" Microphone and a floor-stand-mounted RCA 77D, both in the studio and a 70D Turntable to the left of the TC-4A Audio/Video Console. The RCA Transmitter, TTU-1B, is flanked by rack equipment and directly over the transmitter the filterplexer is mounted.

WSBA plans future expansion of its studio and office facilities and an increase in power with an RCA 10-KW transmitter to provide 170 KW ERP.

#### Control Equipment

Smooth performance is obtained by the proper grouping of important controls contained in the RCA "Basic Buy" TC-4A Audio/Video Console. This console consists of a film camera control unit mounted atop an RCA TM-6A Master Monitor, an

Audio/Video section, remote control section and the TM-6A Preview Monitor. Directly adjacent to the TC-4A Console is a desk rack supporting a field switcher and two field camera control units.

Film equipment consists of two RCA TP-16D Film Projectors and two automatic slide projectors "multiplexed" into an RCA TK-20C Film Camera.

The film camera control unit which is mounted on the extreme left console section of the TC-4A "Basic Buy" console, works in conjunction with the film camera control chassis located in the lower portion of the console housing. Controls for the adjustment of picture levels and shading are located on the sloping desk panel of this console section.

On the sloping panel of the audio/video section (second from the left) program switching pushbutton control is provided—one row of buttons for audio control and one row for video control. The audio portion provides for eight inputs to four mixer positions. Audio key switches provide means of selecting any input such as the turntable, projector, studio, remote or network. The video pushbuttons provide a

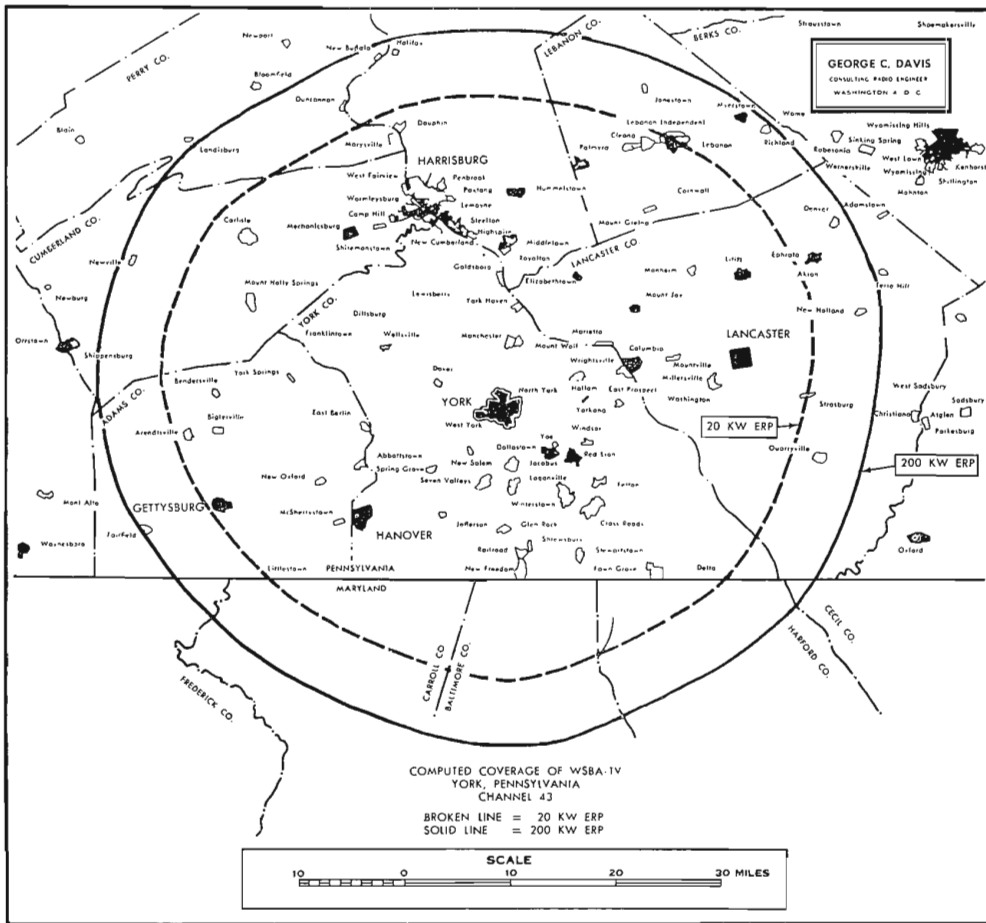

FIG. 3. Coverage map at the signal strengths of 20-KW ERP and 200-KW ERP.

means of selecting any one of eight signals, such as film, studio monoscope, remotes or network for transmission.

Between the preview monitor and the audio/video section is the remote control console section. The two top panels consist of stabilizing amplifier controls, one for network or remotes and one for controlling any signal to the transmitter. The second stabilizing amplifier control may be used for mixing "sync" and video signals. The third panel is the projector switching control. Three "active" groups of push-buttons and tally lights are located on this panel. The groups at either end composed of three buttons and a separate lamp are identical, while one pushbutton and toggle switch are located in the center. The center toggle switch is for turning the power on a slide projector. The pushbutton directly under the switch has a tally light built in and may be used to switch slides in the slide projector.

FIG. 4. Art Hafer, Station Engineer, adjusts the aural transmitter of the TTU-1B.





FIG. 5. Film facilities utilize two RCA TP-16D Projectors, TK-20C Film Camera and two automatic slide projectors.

Further controls may be added in the blank panel positions for additional film projectors, etc.

WSBA-TV's programming facilities are a completely integrated system which provides continuous operation and high quality television transmission to its television audience. The York area television audience has "tagged" WSBA-TV as "their own clear picture television station".

#### Acknowledgment

The WSBA-TV management acknowledges the progressive work of its staff: Walter Rothensies, General Manager; Llewellyn Jones, Chief Engineer; Art Hafer, Assistant Chief Engineer; Tom T. Maloney, Program Director; Joe Alloway, Art Director; George Turner, Film Director; Gail Rider, Director of Continuity; Doris Lenhardt, Traffic Supervisor; Tom Miller, Assistant Film Director; Charlotte Kagan, Continuity Writer. WSBA-TV also wishes to acknowledge the fine work done by Robin Compton, Consulting Engineer, George C. Davis Co., Washington, D. C.

FIG. 6. Cameras shoot programs through studio window.

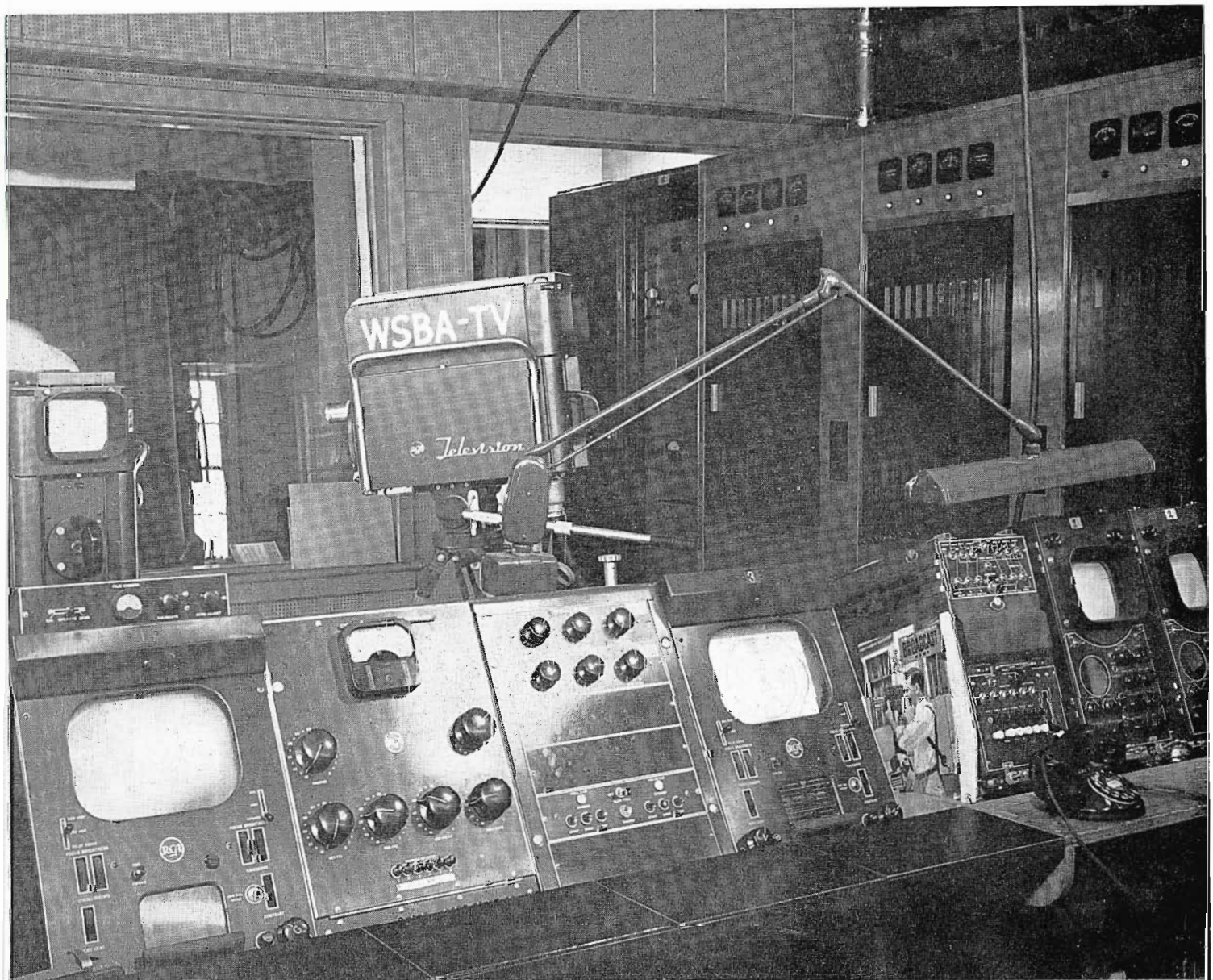



FIG. 1. Assistant Chief Engineer Scott N. Hagenau, center, uses a light meter to check the illumination in the WSBT-TV studio. Looking on are Robert J. Drain, Program Director, left, and Arthur R. O'Neil, right, Chief Engineer. Lighting is provided by banks of incandescent spot lights and high intensity fluorescent tubes.

# WSBT-TV SOUTH BEND, INDIANA

## SOUTH BEND TRIBUNE STATION - UHF CHANNEL 34

It was 11:50 P.M., December 21, 1952, when WSBT-TV came on the air with a live telecast from its studios in the South Bend Tribune building and thus became the first UHF television station in the mid-west. And even at this late hour, the telephones at the transmitter and the studio began to ring congratulations.

WSBT-TV is owned and operated by the South Bend Tribune, and operates on Channel 34 with a visual effective radiated power of 17.5 KW. The antenna is 540 feet above average terrain. The transmitter site is approximately  $4\frac{1}{2}$  miles south of the city and is the highest suitable elevation in the area. It is very suitable for UHF since the terrain slopes downward

By **ARTHUR R. O'NEIL**  
Chief Engineer, WSBT and WSBT-TV

**SCOTT N. HAGENAU**  
Ass't Chief Engineer, WSBT and WSBT-TV

in all directions. This undoubtedly accounts for WSBT-TV's excellent coverage. Furthermore, there are no dead spots.

Heretofore the area had been forced to look for television from VHF stations 74 miles or more distant. Needless to say, even with high gain antennas, a viewer was forced to look through snow, fades, and tears due to man-made noise, to see a picture. Now with a simple antenna, or none at all, viewers are able to watch local

shows and programs from four networks (CBS, NBC, Dumont, ABC) that are perfectly clean.

It has been noted time and again that, in areas where man-made noise made VHF intolerable, UHF is noise free.

The WSBT-TV transmitter is located in the same building which houses the WSBT transmitter. An existing wing of the building was extended to provide additional space to accommodate another workshop, a water cooler room, store room, lavatory, kitchenette and a large area to contain the RCA TTU 10-B 10-KW UHF transmitter and associated equipment. Floor ducts were installed to carry power and interwiring to and from the transmitter. A duct is also provided for water from the cooler room to the transmitter.



The installation was completed in three phases:

- a. Installation of input equipment and control console.
- b. Installation of filterplexer.
- c. Installation of the RCA transmitter (TTU 1-B).

The control console and input equipment was received well ahead of the transmitter. Interwiring was installed and the cable to the transmitter was made up and put in place ready to be connected to the transmitter. Each wire was numbered on both ends and a cross reference chart made up in order to avoid wiring errors and provide a quick check in the event an error did occur.

The filterplexer was flown to South Bend by chartered aircraft and arrived December 19. It was installed the same day. Two horizontal channels provide the main support. The filterplexer is mounted to the channels by four long threaded rods. This method of suspension was devised by WSBT-TV engineer, Lowell Harris. It is hung upside down. Ceiling mounting has proved successful in keeping the filterplexer where danger of damage is minimized and it also does not consume valuable floor space. Mounted in its present position, it will be easy to swing the lines to meet the 10-KW amplifier, when delivered. Thus, it is possible to adjust positioning both vertically and horizontally. Connections were provided for dry nitrogen which pressures the filterplexer.

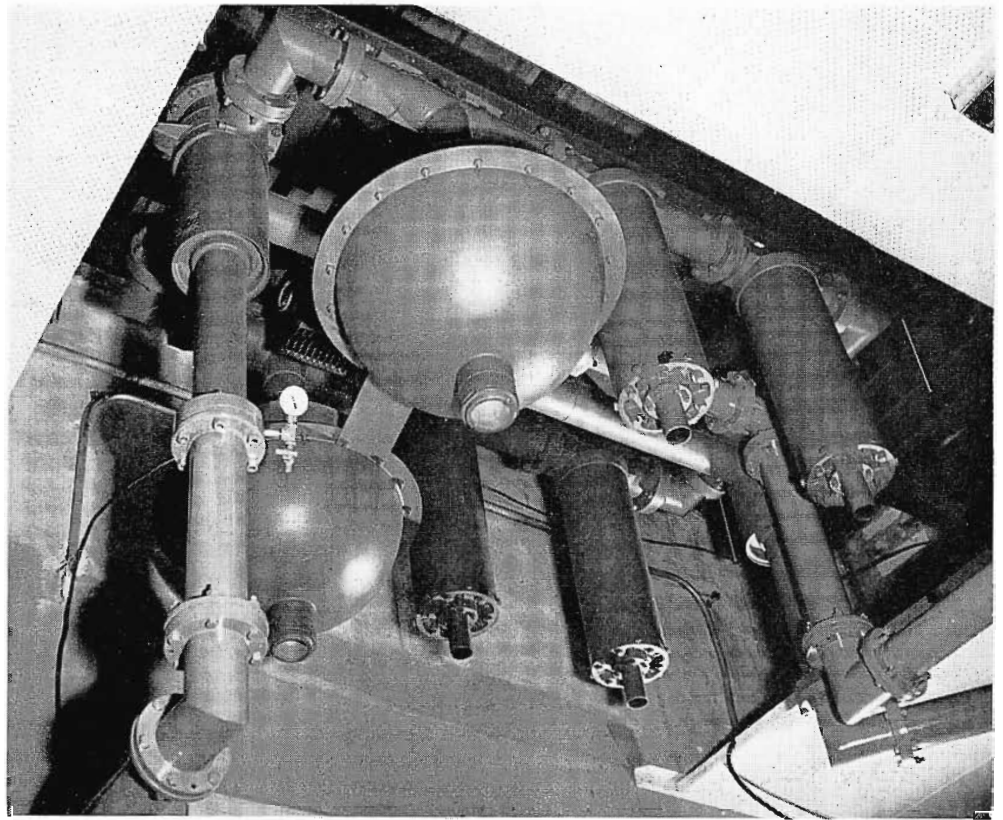

FIG. 2. The RCA Filterplexer (combination sideband filter and constant-impedance notch diplexer) is shown inverted and suspended from ceiling. See Fig. 4.

The  $3\frac{1}{8}$ -inch transmission line (MI-19089-1) to the antenna (approximately 540 feet overall) is kept under pressure with dry air derived from a compressor and dehydrator. This line is insulated a quarter wave at 960 KC since this tower is a part of the WSBT antenna array. Since ice falls are a problem the horizontal run of coaxial line is protected by a shield to break the ice. The transmitter building

roof is of structural steel and the windows are safety glass for the same reason.

The transmitter, shipped by special van from Camden, New Jersey, arrived on December 20, and was ready for the tune-up process accomplished by Tom Gluyas and Paul McNichol of RCA, that evening. These gentlemen, incidentally, did a splendid and efficient job in tune-up and in

FIG. 3. WSBT-TV engineer Lowell Harris tuning aural transmitter.

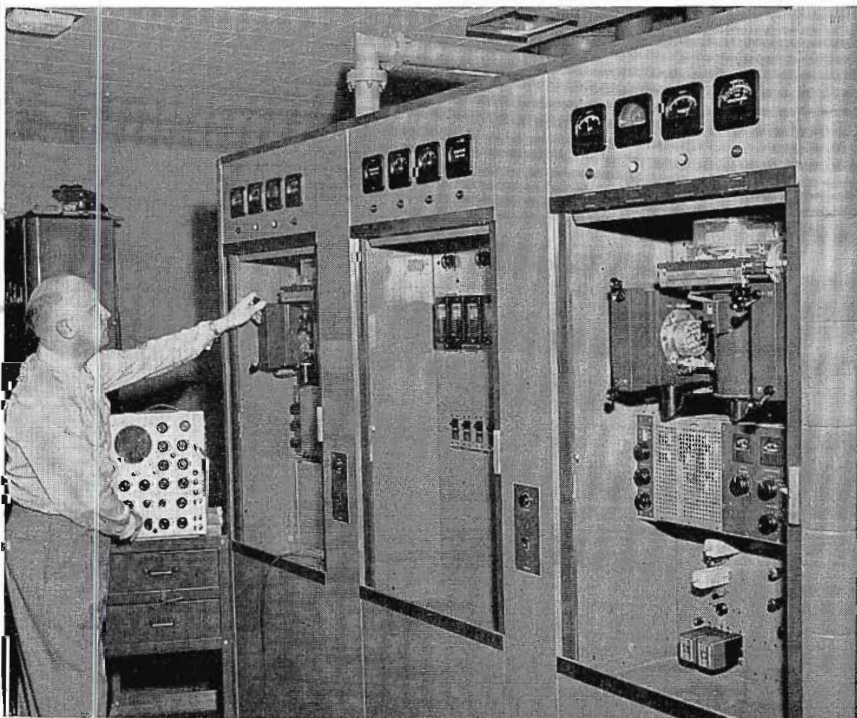
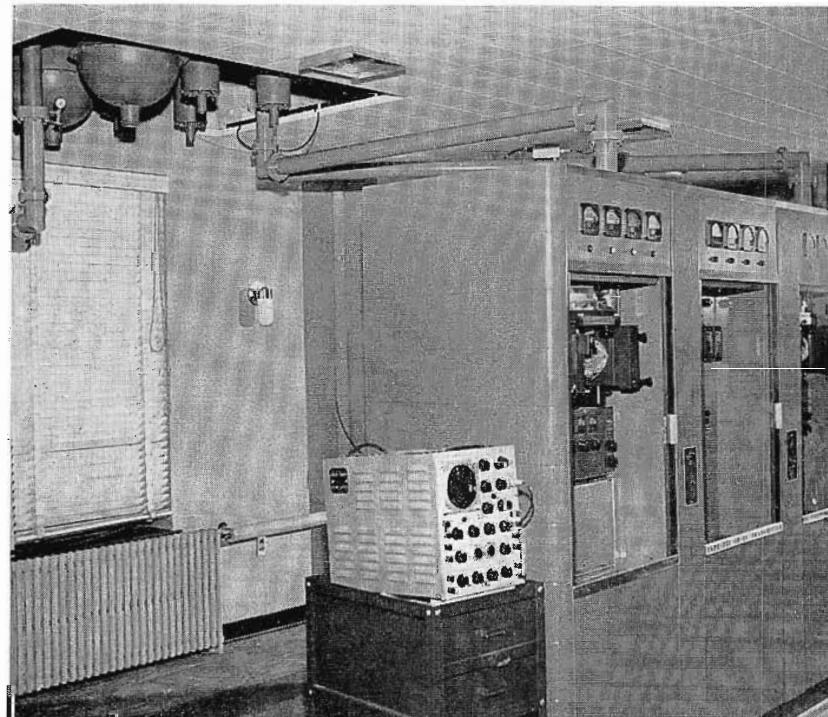

FIG. 4. View of the transmitter room. The transmitter plenum is not yet in place although the exhaust ducts may be seen. Note that the coax from the filterplexer may be swung to the right and left to meet the 10-KW amplifiers when delivered.



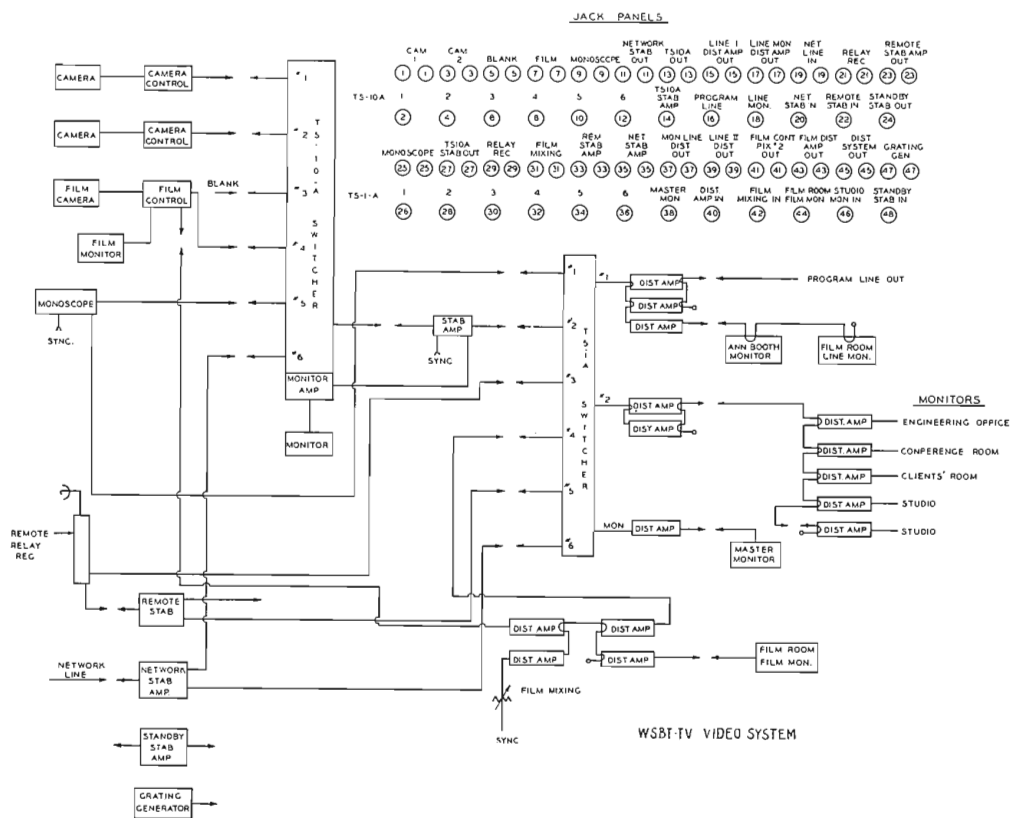

FIG. 5. Plan showing WSBT-TV video system.

giving instructions to our personnel in the operation and maintenance to be required.

Since going on the air, the building has been completed. A plenum has been installed over the transmitter to carry the

air outside. A perforated metal ceiling furnishes cooling air to the room.

Video signal is delivered to the transmitter from the studios over cable and microwave leased from the Indiana Bell

FIG. 6. WSBT-TV control room. In charge of the co-ordinated operation is Justin Meacham, left, Production Director. Seated, left to right at the control console, are: Oliver Parcher, Assistant Production Director, Engineer Jack Gilliom, at controls monitoring the television picture, and Engineer Earl Johnson, at the sound monitoring station.

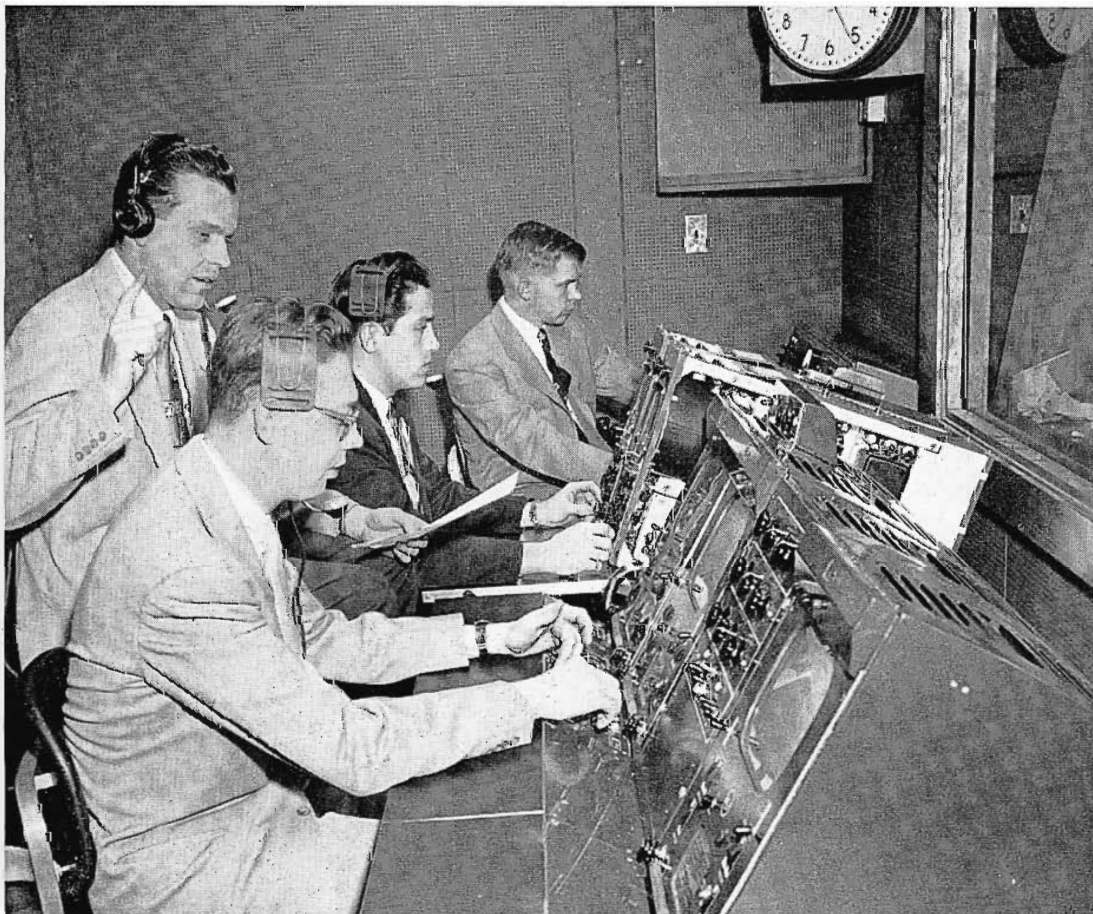

Telephone Company. Cable carries the signal from the studio to an Indiana Bell building where it is sent to the transmitters on the RCA TTR-1B and TRR-1B microwave system. A passive reflector is mounted approximately 230 feet up the television tower at the transmitters which reflects the signal to the TRR-1B receiver mounted on the ground just outside the transmitter building. The two principal advantages of this method are: Servicing of equipment can be accomplished on the ground. Complicated isolation to maintain the tower above ground at the AM station frequency is not required.

After visiting numerous television stations during the planning stage of WSBT-TV, it was decided to convert existing AM studio facilities for TV use. In this manner, we can operate until such time as definite space requirements are determined. At this time facilities can be constructed which would properly meet the requirements of our market area.

Studio facilities are on the third floor of the South Bend Tribune building and occupy space gained from WSBT. (See March-April 1952 issue of BROADCAST News.) AM studio "A" was converted to a television studio by the addition of pipe rack supports to the ceiling for mounting lighting equipment. "A" control room was converted to TV control using the same audio equipment already installed, and adding the necessary video equipment. A door was cut through from the control room to the adjacent "music file" room where the audio and video rack equipment is installed. A corner of this room was used for an announce booth. The film equipment was installed in a storage room across the hall.

All racks are mounted on 6-inch channels which provide sufficient wiring space. Floor ducts did not exist in this area and the construction of the floor did not make it feasible to build in new ducts. Conditioned air is blown through the ceiling to cool the racks.

The studio installation was completed in nine days under the supervision of WSBT-TV engineer Kenneth Kuespert and preceded the transmitter installation approximately three weeks. All interwiring was charted, numbered and precut so that tying the ends was a simple matter. Careful checking of wiring charts kept wiring errors to a minimum.

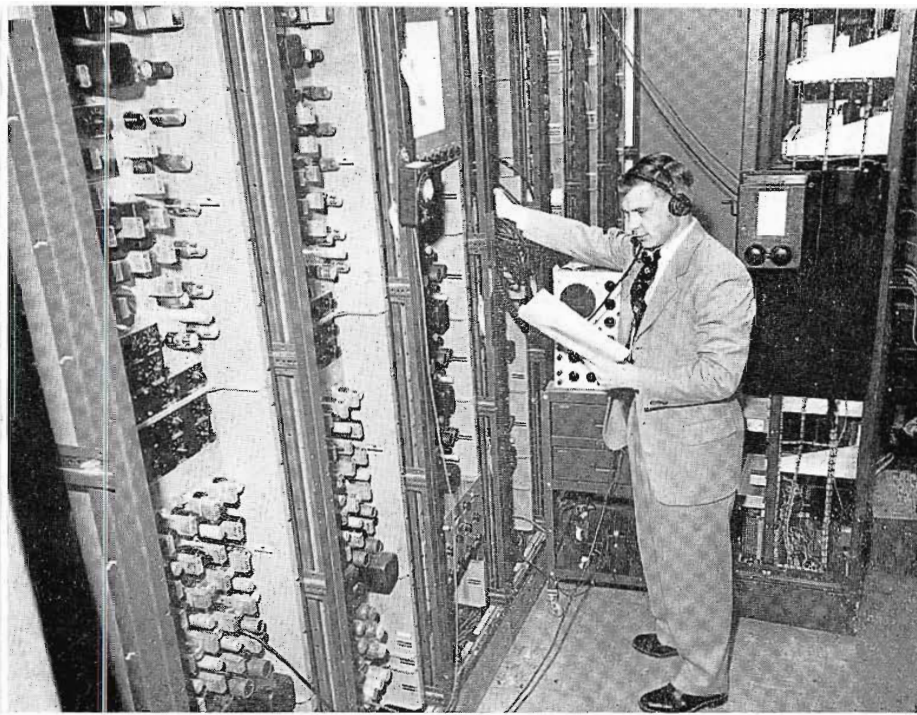

FIG. 7. WSBT-TV Engineer Earl Johnson checks the wiring diagram of studio rack equipment.



FIG. 8. WSBT-TV Engineer, Howard Paulsen, is shown seated at the RCA TTC-1B transmitter control console. Sufficient blank space is left in the rack to receive a demodulator and sideband response analyzer.

Entire credit for these installation feats goes to the WSBT and WSBT-TV engineering staff who worked with complete enthusiasm and zeal. The basic staff is comprised of existing members of the AM staff who had had little or no television experience. This staff has been augmented by additional personnel until a full, integrated staff was available. Operation of both stations has been continued on a fully integrated basis which has been very successful.

Time did not permit completion of the training program that we had originally outlined, however, a part-time training program coupled with individual efforts of the staff members has proved that an AM man can master this new equipment.

Although WSBT-TV bettered its original "on the air" date by about six months, operation and layout have not suffered.

Transmitter and studio equipment has been performing very satisfactorily. Although the transmitter differs considerably from a VHF transmitter, it is felt that no peculiar problems exist with UHF. The same practice and standards have been applied with no difficulty. Future plans also call for installation of the RCA 10-KW amplifier.

WSBT-TV now operates with test pattern from 10:00 A.M. until 5:00 P.M. Monday through Saturday. Programming, except for special events, commences at

5:00 P.M. and runs until approximately 10:30 P.M. On Sunday, programming begins at 12:00 noon and runs through 11:30 P.M.

Program plans call for expanded use of the WSBT-TV remote equipment and for a gradual extension of programming hours both into the afternoon and evening hours.

FIG. 9. WSBT-TV predicted service contours.

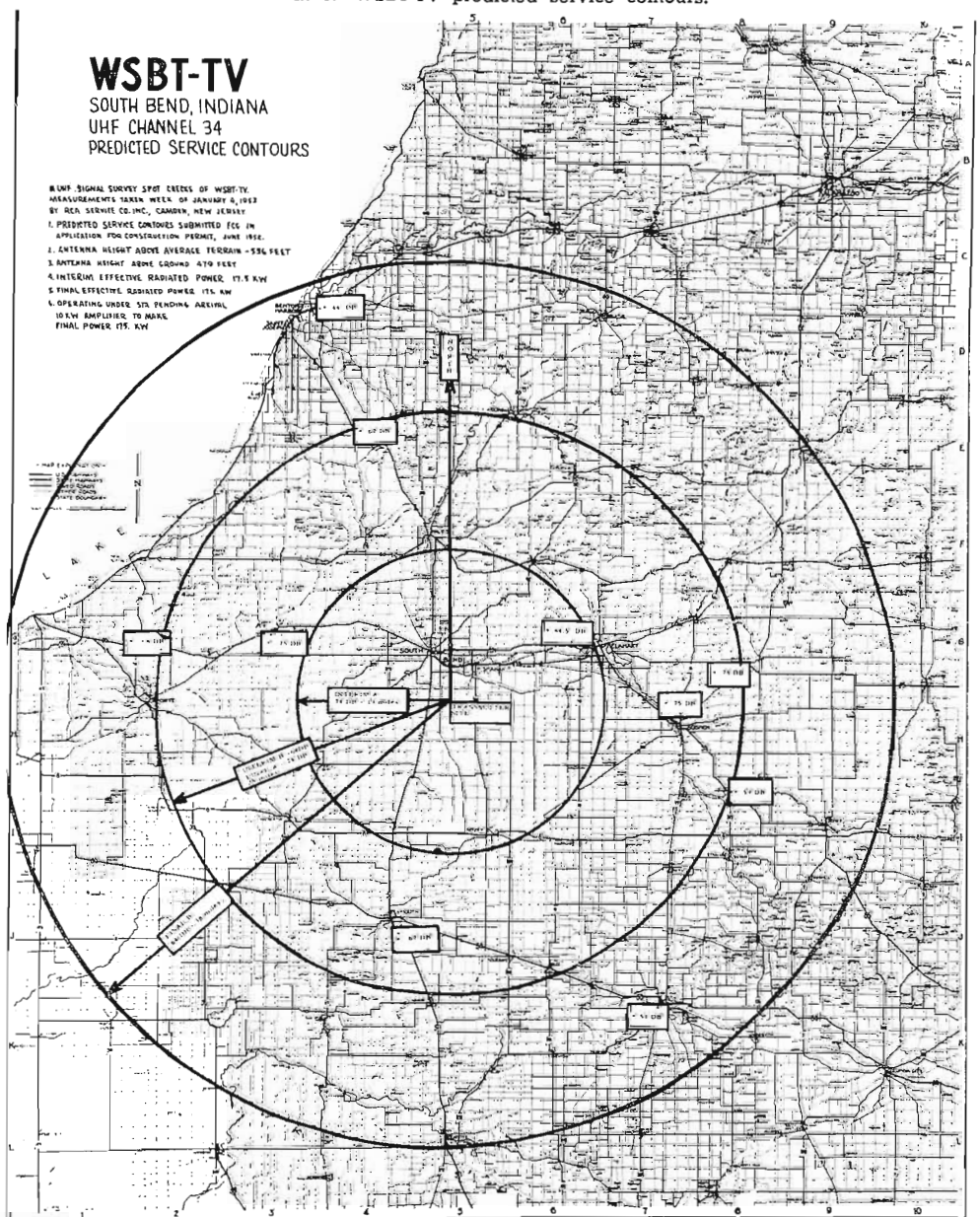

# WKNB-TV

## NEW BRITAIN, CONNECTICUT UHF CHANNEL 30

By **JOHN SHIPLEY**  
Chief Engineer, WKNB



FIG. 1. The WKNB-TV transmitter, located atop Rattlesnake Mountain, overlooking the Connecticut River Valley.

FIG. 2 (below). WKNB-TV Station Manager Peter B. Kenney and President Julian Gross throw switch at start of station's operations on Friday, February 13. Hartford County's first television station went on the air commercially at 4:30 that day. Test pattern "on-air" two days previously.

On November 2, 1952, two days after the issuance of a construction permit, the first spadeful of earth was removed from the site of the tower pier for WKNB-TV, New Britain, Connecticut. This was the first visible sign of progress in the effort to bring New England its first UHF television station. Less than three months later, on Friday, February 13, 1953, commercial program operations began.

We had chosen the top of Rattlesnake Mountain, one of the highest points in Central Connecticut, overlooking the broad expanse of the Connecticut River Valley extending from Long Island Sound into industrial Massachusetts. The transmitter site is at Farmington, Conn., about 4 miles northwest of the business center of New Britain, Conn. A triangular, guyed tower 500 feet high supports the RCA UHF



Pylon antenna. Terrain and tower provide a combined height of 1285 feet above sea level.

This location was an excellent choice from a transmission standpoint, but it left much to be desired as a construction location. Throughout the busy days of construction most of our problems seemed to be the direct result of our choice of transmitter site. Every hole in "earth", whether it was intended for a telephone pole, tower guy anchor or building foundation had to be wholly or partially blasted out.

After blasting out the tower pier foundation and the guy anchor points, the precipitous nature of the terrain coupled with the rigors of a New England winter made the pouring of the completed concrete foundations very difficult. Bulldozers were employed to assist giant cement mixers up the steep, icy road and to the edges of cliffs where cement was poured down steep slopes through wooden sluice-ways. At other points, long boardwalks were erected across crevices and the concrete was carried by wheelbarrow. Long motorcades of dump trucks carried crushed rock and fill to the mountain top after completion of the foundations to make working room for the tower erector.

Actual construction of the tower was quite uneventful although the period between the completion of the tower and the placement of the antenna was quite harrowing.

During early January, one of the heaviest accumulations of ice in history formed in this portion of New England. Ice formations on the  $\frac{5}{8}$ -inch guy cables reached a diameter of four inches. Only from one side of the tower was the painted surface of the structure visible. The remainder was coated with thick rolls of ice, the weight of which was calculated by our mechanical engineer consultant to be about thirty tons.

We were particularly concerned over the safety of the antenna which still rested horizontally on trestles about thirty feet from the base of the tower. We had been

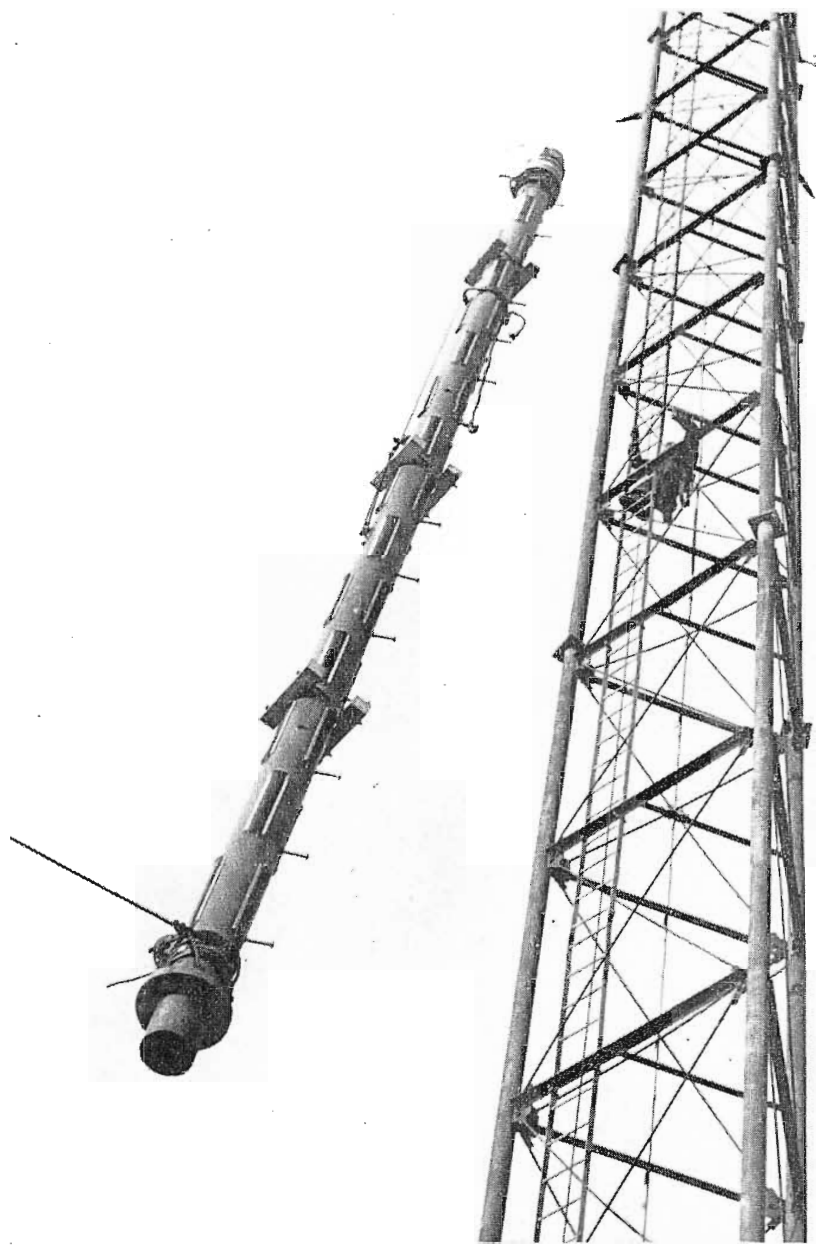

FIG. 3. Checking progress every step of the way, tower climbers keep pace with the rising RCA UHF Pylon antenna. This photo was taken as the antenna reached the 300-foot mark.

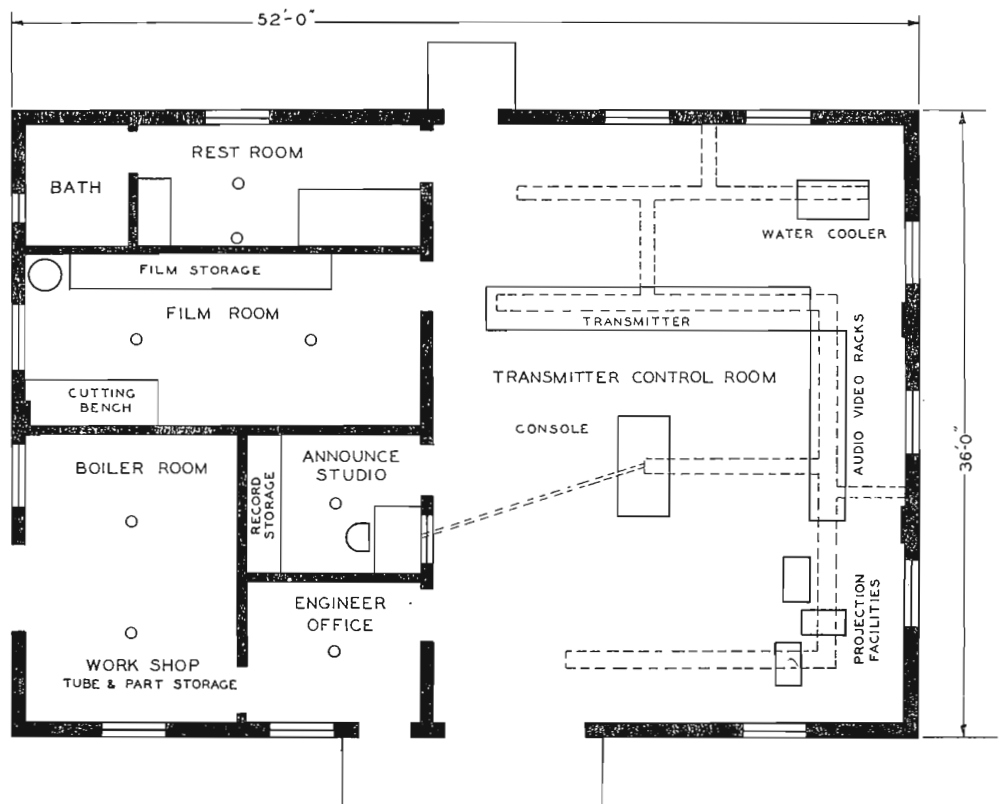

FIG. 4. Floor plan showing WKNB-TV's transmitter layout and facilities.

carefully instructed concerning the delicate nature of the antenna. We felt that small pieces of ice falling from such a great height might cause severe damage to the antenna. We were little prepared for the devastating avalanche of ice which fell during a warm evening a few nights later. With the exception of three pieces of ice which remained on the rest platforms, all of the ice on the tower fell in one terrible mass. A stiff breeze carried most of it into the antenna resting area. The next morning we returned to inspect the damage. The entire area was total chaos. Huge six by six timbers had been shattered like matchsticks. Concrete blocks had been crushed. Fortunately, although it had been struck by collapsing staging and tons of ice, the antenna remained on its sturdy trestles. Nearly half of the flexible plastic slot covers on the antenna were damaged. The heavy cover was forced down with such force against the slot in the antenna that it was cut as cleanly as if by a razor blade.

Although we were resigned to sending the antenna back to Camden for repair, we called in the RCA Service Company engineer. We were amazed to find that after a few minor adjustments to the antenna elements and the replacement of many of the slot covers, the antenna was as good as new.

While all of this physical construction was taking place, the television equipment was being unpacked, assembled and wired miles away in rented space. We began placing the equipment in the transmitter building two days after the cement floor was poured.

Two huge oil burners had been running night and day within the closed-in structure to melt the ice and frozen earth to prepare it for the concrete slab.

Our fast-paced construction schedule would not permit us the luxury of completion of the tile flooring before the actual installation of the equipment. Our haste may have been ill-advised since we have been plagued ever since with the talc-like dust from the floor and walls.

This dust was the direct cause of our only serious loss of air time. During the installation of the RCA TTU 1-B UHF

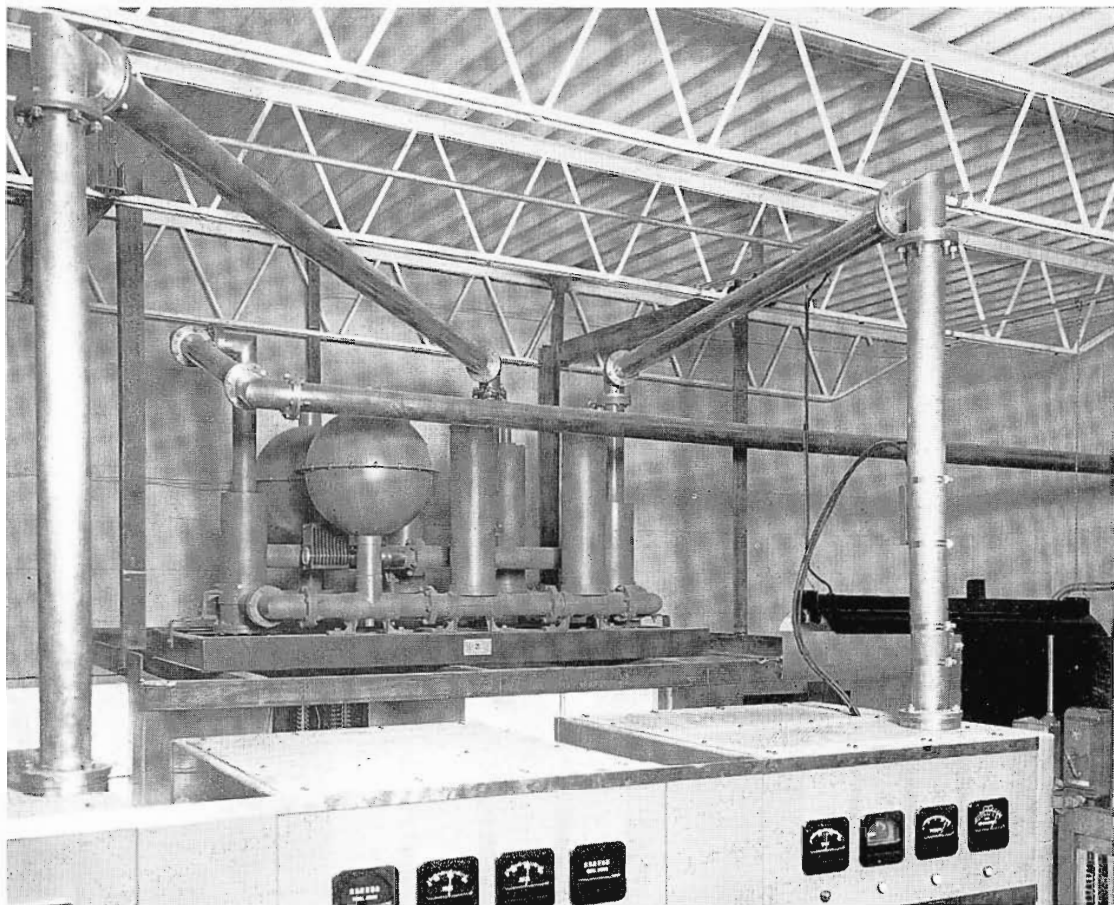
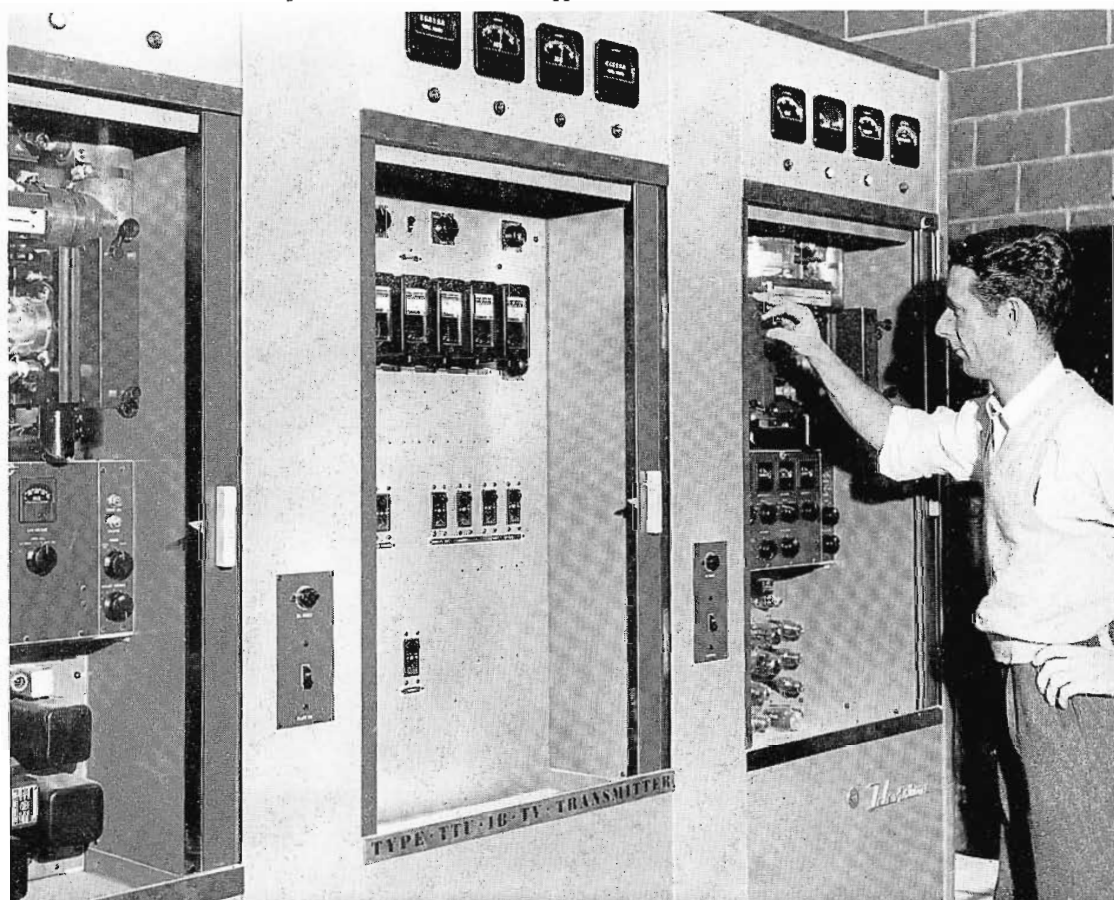

FIG. 5. Filterplexer arrangement as it is suspended from ceiling of WKNB-TV transmitter building.

FIG. 6. WKNB-TV Engineer Lew Lindquist shown at transmitter. Opened doors afford good view of the RCA Type TTU-1B UHF Transmitter.



transmitter, the transmitter was operated without the dust filters. Clouds of dust have settled in every portion of the transmitter to be possible sources of outage. Two hours of air time were lost when this dust provided a firing path for the final amplifier plate voltage around one of the insulating micas in the tuned cavity. Simple precautions against dust would have prevented this occurrence.

Our entire installation was installed and wired by engineers with no television experience. These same engineers are now operating and servicing the equipment with more smoothness and efficiency than is normally seen in a new operation.

Already plans are being drawn for the construction of a new studio and office building to house both WKNB-TV and WKNB-radio. This new building will provide facilities for the origination of local programs—programs which might include picturizations of legislative hearings, panel discussions of civic topics, talent entertainment and coverage of news events, to provide a balance to the network entertainment shows already scheduled.

Through its affiliation with CBS-TV, WKNB-TV is now bringing some of the best entertainment in the country to the Connecticut and western Massachusetts viewers.

WKNB-TV is a young station and a pioneer on UHF Channel 30 in Connecticut. Its staff, comprising many service veterans, is youthful, with a wealth of training and practical electronic know-how.

The end result of our efforts is the enthusiastic reception given it by the rich community it is meant to serve. Terrain problems have been practically negligible from a market standpoint. Our primary coverage area seems to be about 85% saturated with our signal. Portions of Massachusetts, thirty miles and more from our transmitting site are consistently reporting excellent, snow-free reception. Dealers in our area are featuring photographs of our received signal in their advertisements. Any doubts which may have existed regarding the reliability of UHF television have vanished and WKNB looks ahead to a future full of promise and achievement.

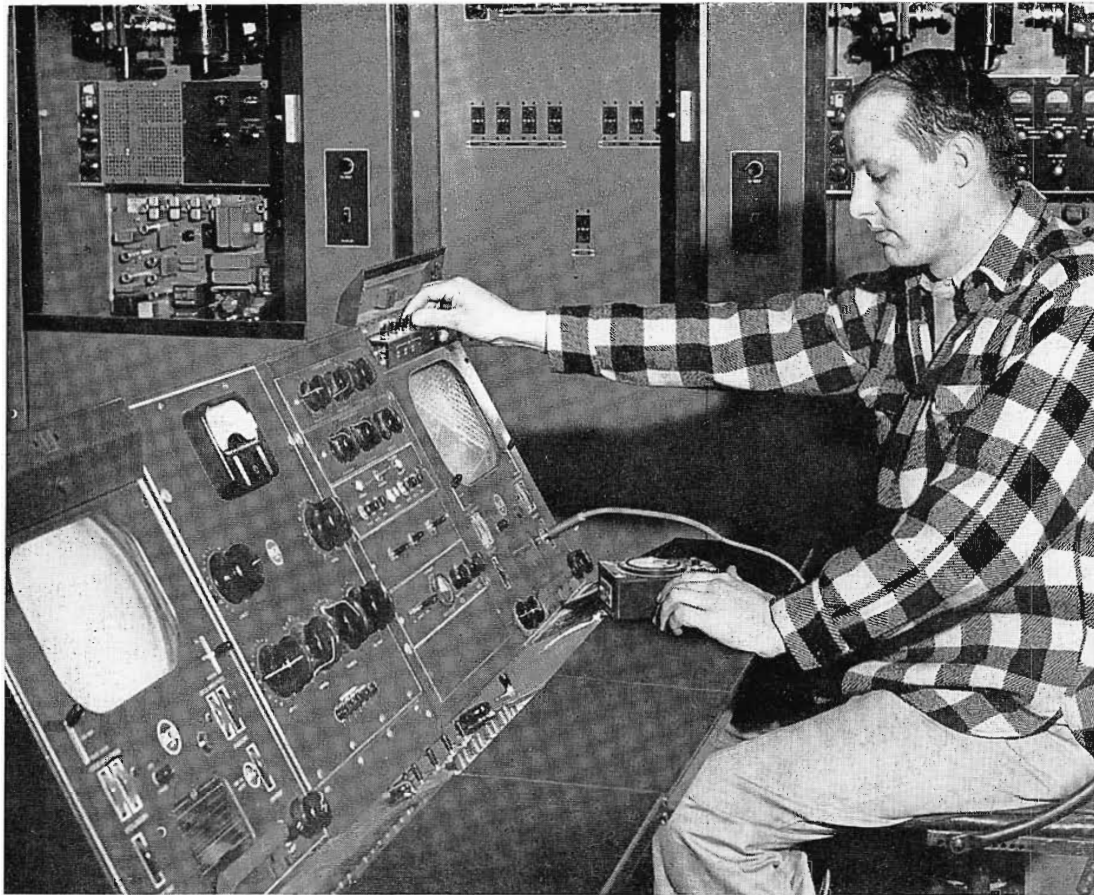
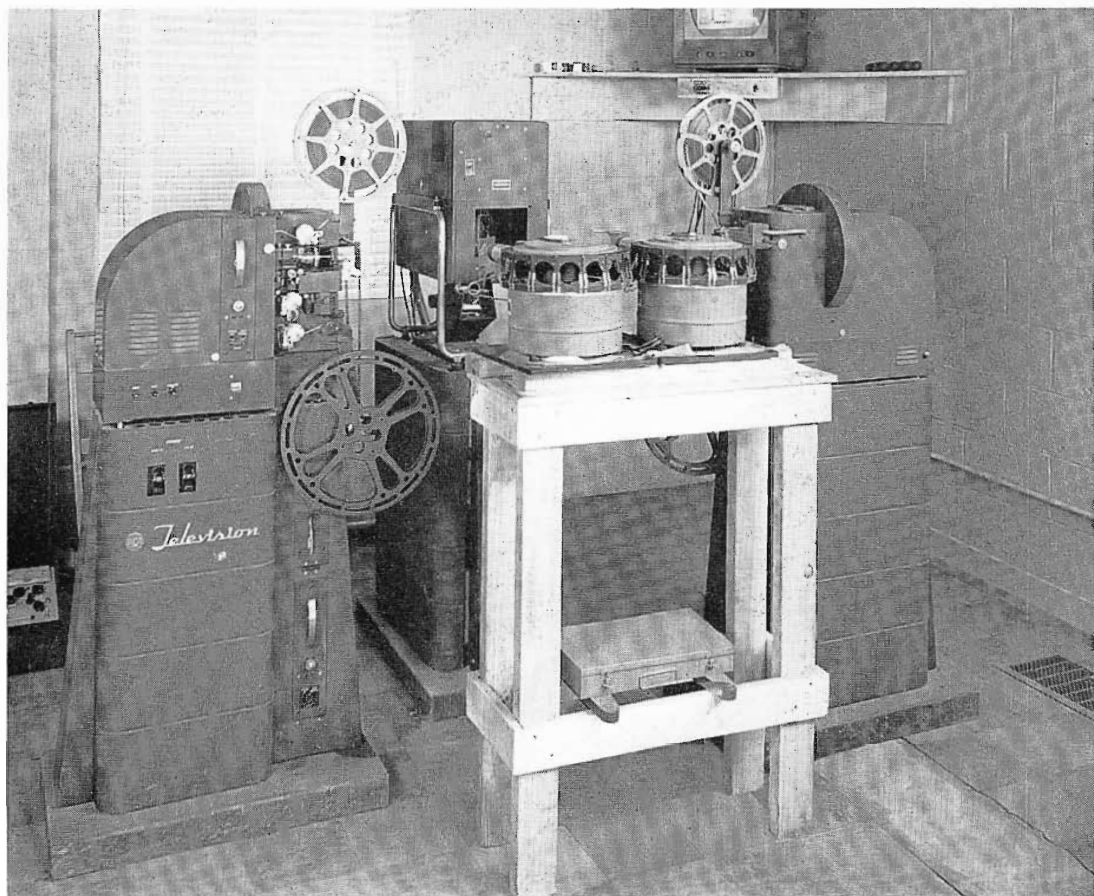
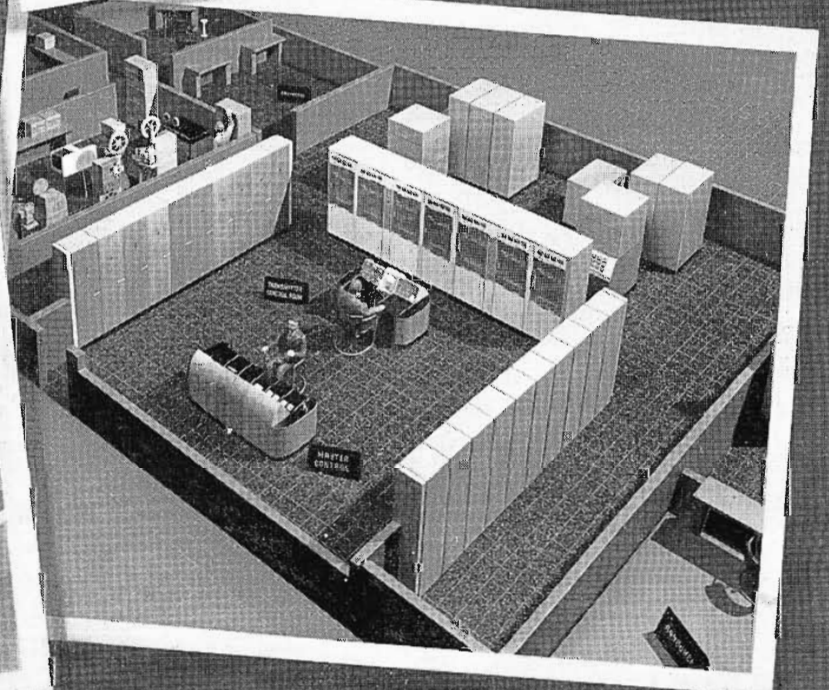
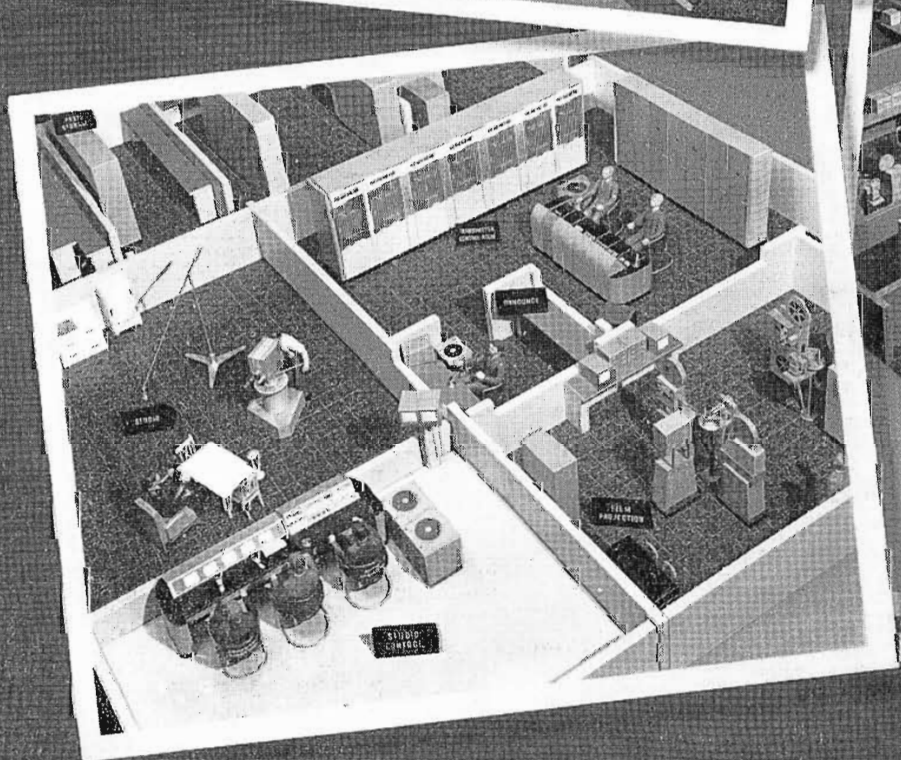
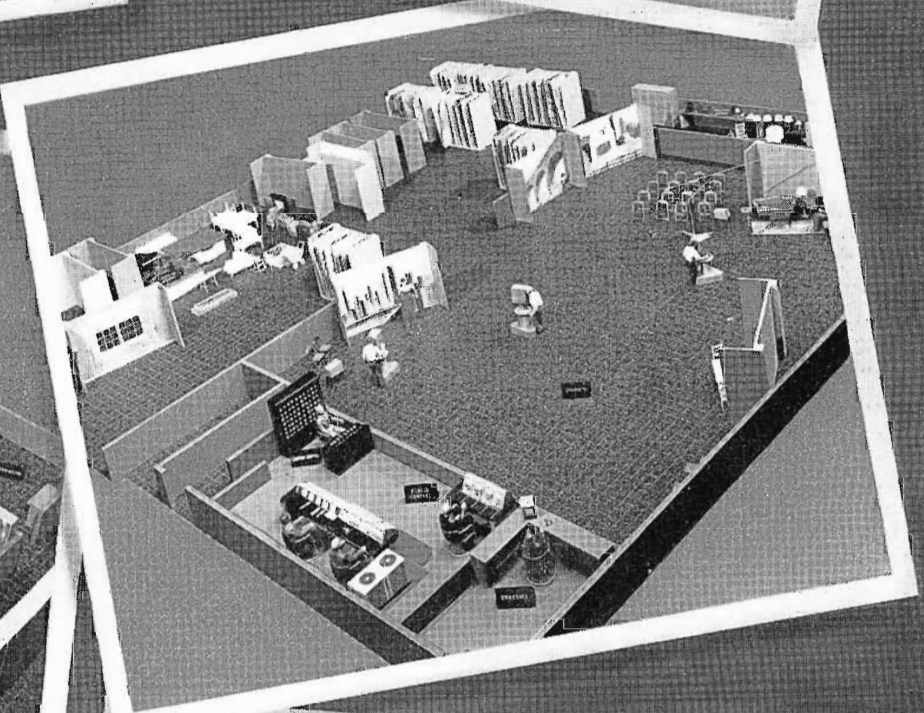
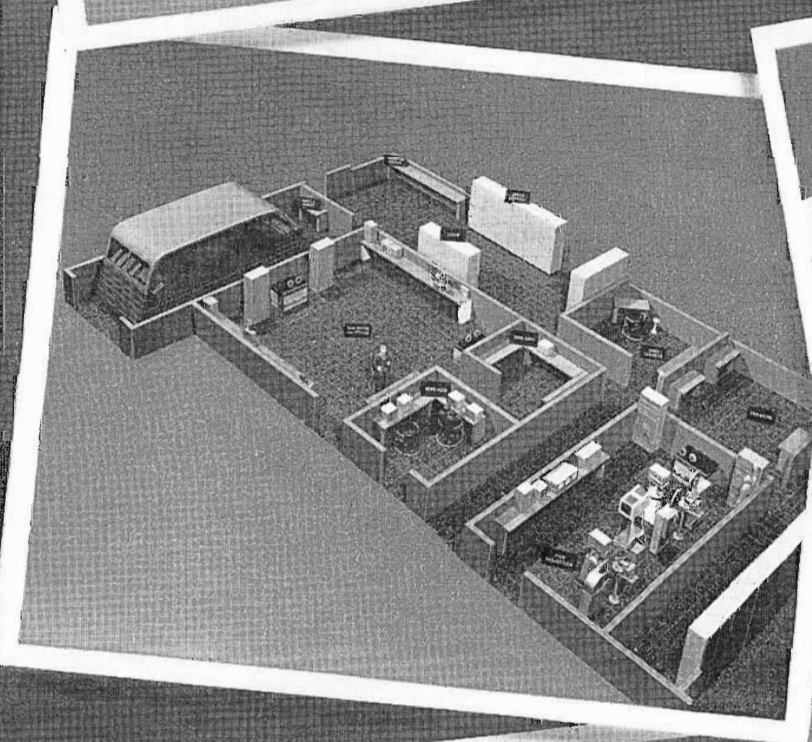
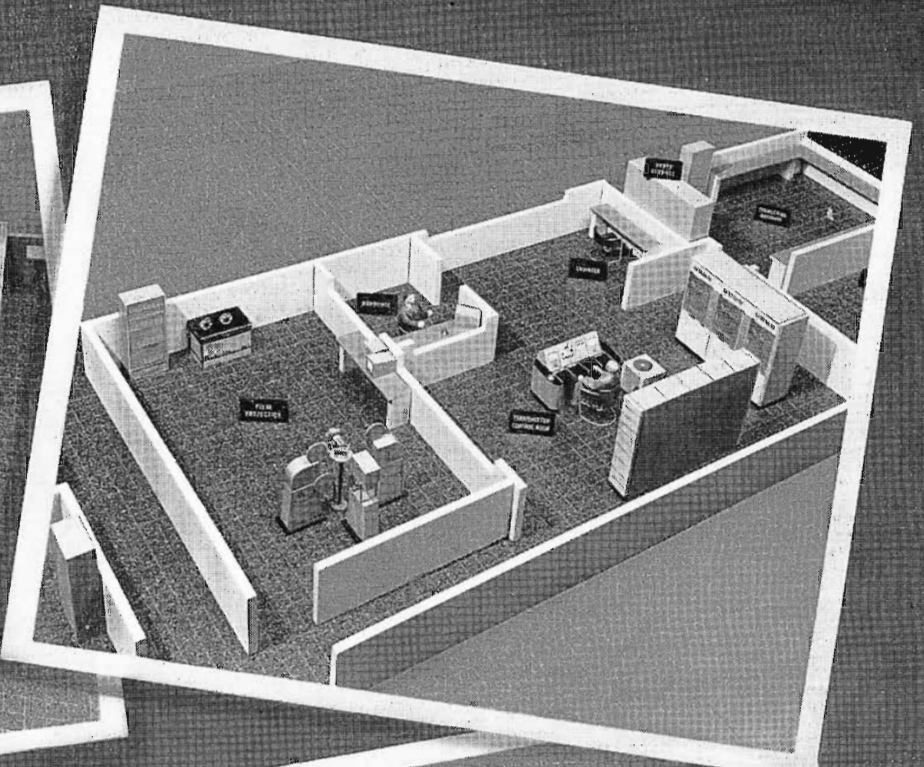

FIG. 7. WKNB-TV Engineer Ed Finnerty pictured at the RCA TC-4A control console.

FIG. 8. Film equipment at WKNB-TV consists of two RCA TP-16D projectors, the TK-20C film camera and two automatic slide projectors.







# FOUR VERSATILE TV STATION EQUIPMENT PLANS FOR VHF and UHF

## Plans Completely Cover Four Station Categories for "Combined" Studio - Transmitter Operation

### Introduction to Plans

The careful and considered planning of the technical equipment for a Television station is the next logical step after early planning has been completed. Early plans usually involve such considerations as the market to be served, site selection, effective radiated power, antenna height and gain, sources of program material, station policies, personnel and extent of programming, capital investments, future expansion, and the planning of the building.

It is the purpose of this article to assist the "TV Planner" in determining the class of operation which meets his requirements and to aid him in the selection of the proper technical equipment to assure efficient operation. The plans covered do not necessarily represent any existing station but they do illustrate several ways in which the very latest equipment may be arranged to perform efficiently with a minimum of equipment and personnel.

### Equipment Plans Are Divided into Four Classes of Operation

"Hand-in-hand" with the building design and construction goes the proper selection and layout of technical equipment to satisfy contemplated programming requirements.

Since programming requirements will vary widely and range from simple to complex, four general equipment plans were selected to represent well-equipped TV stations for four specific categories of operation. The need for building and companion equipment plans that may grow logically at minimum cost was considered essential in selecting the following equipment groupings. Plan "A", "A-Prime" and "B" are versatile and permit expansion of both the building and equipment at minimum cost. Plan "C" represents a larger type of operation and is not a direct outgrowth of any of the other plans. Although individual station requirements, budget ap-

By  
**L. E. ANDERSON**

and

**W. O. HADLOCK**

RCA Engineering Products Department

propriations, and scope of operations are seldom alike—the four plans are considered adequate to satisfy a majority of cases. The four distinct groupings of equipment or classes of operation range from Plan "A" (a film and network only station) to Plan "C" (a fairly large, "two-studio" station with remote facilities). TV stations with more complex arrangements of program sources than Plan "C" will fall into the "custom" planning category requiring special consideration and investigation. Description of this type of station, therefore, is beyond the scope of this article. It should not be expected that the four plans treated here will not require any special considerations—because it has been

found in practice that even the simplest station plans have small deviations that require special attention.

The four station plans are divided into station groupings as shown below. The "A-Prime" layout corresponds almost exactly, from an equipment standpoint, to the popular RCA "Basic Buy" station.

All equipment setups correspond to or parallel very closely (from a programming and operation standpoint) those included in the previously published material listed below. Thus, together with the information presented in this article, the TV planner has available fully integrated plans which will provide him with the necessary source material to estimate Operating, Equipment and Building costs.

"Considerations in the Early Planning of TV Stations," by J. L. Herold, BROADCAST NEWS No. 69, May-June, 1952.

"TV Station Operating Costs," by J. L. Herold, BROADCAST NEWS No. 68, March-April, 1952.

"Television—What and How to Build," by Ben Adler and Rene Brugnioni, BROADCAST NEWS No. 72, Jan.-Feb., 1953.

Station Group	Transmitter Power	Program Sources
+ "A"	TTU-1B, 1-KW, UHF TT-2AL/AH, 2-KW, VHF TT-500, 500 watt	Film, slides and network
+ "A-Prime"	TTU-1B, 1-KW, UHF TT-2AL/AH, 2-KW, VHF	Same as above, plus "Single-Camera" Live Studio
* "B"	TT-10B, 10-KW, UHF TT-10AL/AH, 10-KW, VHF	Same as above, but "2-Camera" Live Studio
* "C"	TT-10B, 10-KW, UHF TT-25BL/BH, 25-KW, VHF TT-50AL/AH, 50-KW, VHF	Same as above, with "2-Studio" Live and Remote

FIG. 1. Chart showing the four station categories and associated transmitters and program sources.

† Transmitters of higher power are equally applicable where space permits.

\* Transmitters of lower power are equally applicable to these plans.

# GENERAL PLANNING CONSIDERATIONS

## Considerations in Choosing an Equipment Plan

In order to reduce the number of variables and simplify the presentation of this material, all four equipment plans chosen cover only "combined" types of operation where studio and transmitter equipment are located in the same building. It is worthy of note, however, that the equipment plans presented are also practical when "divided-up" and applied to situations where transmitting and studio equipment are remotely located. In these cases, coaxial cables, equalized lines or microwave facilities would be required to link the two functions, (see Fig. 2) plus the possible addition of video amplifiers at the transmitter location.

The TV Planner's choice of one of these equipment layouts will depend to a large degree on factors which he has already determined such as: the type of programming, area or community to be served, network facilities available and extent of remote programming. Transmitting equipment requirements for the various plans will be quite similar except for the possible use of different values of Effective Radiated Power. This requires the use of different transmitter power levels and antenna gains.

If the station is a network origination point located in a large city, requirements may dictate a multiple studio installation employing several cameras, associated control equipment, master control equipment and extensive distribution facilities. On the other hand, a network affiliated station in a small community may need only simple studio facilities. In some instances, network affiliated stations in small communities may not have any origination facilities except a single studio camera chain for announce pickups, simple interviews, and advertising sets. A slide projector and movie projectors with a film camera chain would round out the system for a start.

FIG. 2. Equipment plans may be "divided-up" so that studio and transmitter facilities are remotely located, in which case microwave or coax links could be employed.

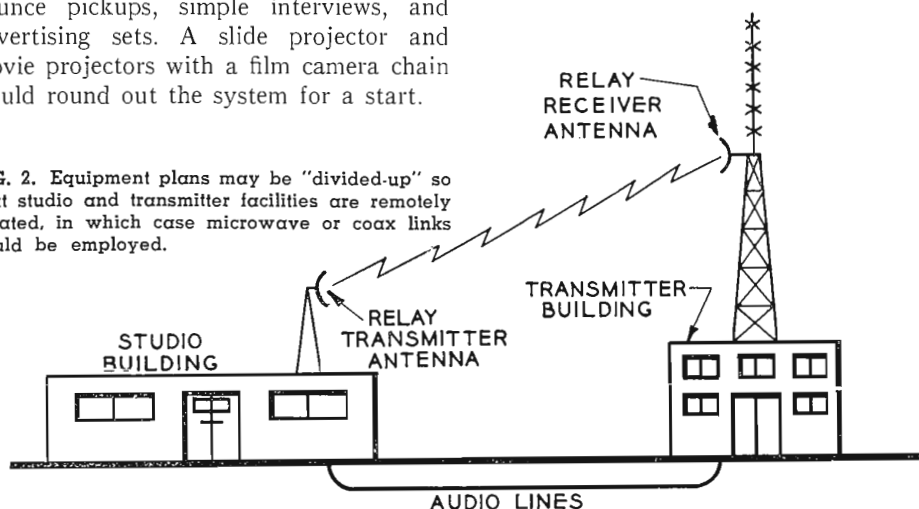

Of course, the simplest and most inexpensive type of television station to equip would be one that plans to use network programs entirely. However, in such a station there would be no means of presenting essential local advertising material or station call letters. A more practical station is one which can present local film programs interspersed with network (such as Plan "A"). Because film is a very important part in TV Station programming, editing, rewind, splicing and storage facilities are included in each plan.

One step further, and perhaps a wise one, is to equip the station with a small studio to produce live program material, as well as film (such as Plan "A-Prime"). A studio of the size shown in Plan "A-Prime" is not intended to be adequate for the handling of elaborate studio shows but does permit local live talent showings, personal interviews, and showing of the sponsor's products. In both plans, "A" and "A-Prime", all video controls and transmitter controls are located in the same room, at a centralized console.

A great many stations will find it economically feasible to start with provisions for a moderate-sized, two-camera studio with a separate control room (such as included in Plan "B") in order to accommodate larger TV shows. Plan "C", of course, with its two full-sized studios, control rooms, and remote facilities is equipped for more elaborate programming suitable for metropolitan-type operation.

For the advanced "B" and the "C" station plans presented, single camera chains, amplifiers, monitors, or the like may be added at will without greatly altering the rest of the station's equipment. Moreover,

these units are of matched design and operate at standard levels into standard impedances. Thus, most input and output connections may be patched in or out, as desired. Units are also alike in styling and appearance and are the same equipment as that employed by the largest network stations.

## Basic Control Room Considerations

All TV installations, large or small, are alike in many respects. The difference in size, for instance, is mostly a matter of the number of cameras and studios involved. The single studio of a small station and its associated control room may be almost identical to one of the studios and associated control rooms of a larger station. Thus, the general arrangements of the equipment for the control room may also be quite similar. Moreover, the equipment for all stations is made up from the same basic units. And finally, the basic control system used in all of them performs the same functions.

However, this article would be incomplete if it failed to point out that there are various deviations in arrangement of studio and control room facilities to suit special conditions and personal tastes. For example, it is not necessary that video control operators be able to see into the studio since their primary function is to maintain control of the picture signals emanating from a camera. It is more important that the program director be able to see the production.

It would be possible to place a program director's console directly in front of the studio window, and locate the camera controls at one side or even in a different room, if the switching unit and a picture monitor for each signal source are located in a console on the platform directly in front of the director. In some large stations, all of the camera controls have been placed in master control. This, of course, centralizes all the operational equipment in one spot but requires remote video relay switching and fading to be effective in saving personnel and avoiding many long cable runs. The program director also has control of switching either directly or indirectly. The audio operator should also be able to see the studio action to be able to ride gain properly.

On the other hand, for economic reasons primarily, some stations may require that the camera controls must be located in front of the studio window in order that

the program director in the back of the control room, who is located on a raised platform, may see both the studio action and the associated monitors at a glance (see Fig. 3). This arrangement requires fewer monitors but causes the view of the program director to be restricted by the presence of the video operators.

In smaller installations, all controls may be located where a view of the transmitter, projection room, announce booth, and even a small studio is possible. Such operating conditions are satisfied by the "A" and "A-Prime" plans.

### Studios and Announce Booths

The TV studio should be large enough to provide for as many sets as possible which may be successive scenes in a play or advertising program; while control rooms should be made large enough to admit additional equipment as the station grows. As a matter of fact, the floor plan of "A" can serve as a basic building block for plans "A-Prime" and "B". At least one announce booth is essential in any TV Station layout. Such a booth is provided with the necessary audio facilities and a

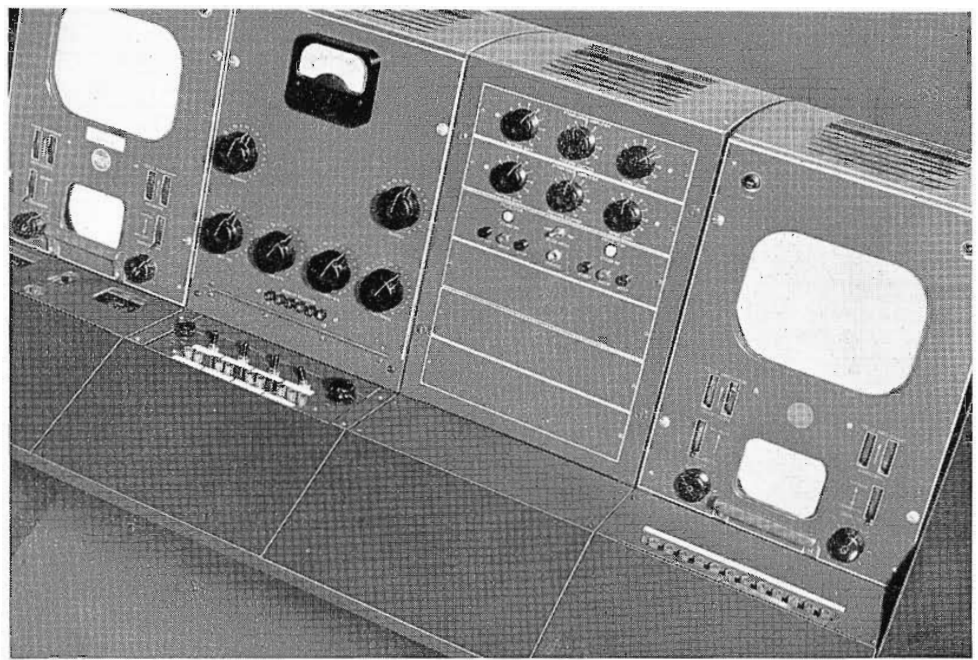

FIG. 4. Closeup of the four console sections which are used as the basic "building block" for the combination transmitter/master control rooms in all four plans.

era, include video control consoles which are made up of standard sections referred to as camera control units. There is one of these control units for each studio camera and one for each film camera. Each unit contains a picture monitor showing at all times the picture picked up by the associated camera. It also contains an oscilloscope for "wave-form" monitoring and the necessary controls for adjusting brightness, contrast and electrical focus. The

signals from the cameras are mixed (or switched) in the same manner as microphone and transcription inputs are mixed at the audio console. From the video switching console, the picture signal is fed either directly to the transmitter line or to a master control room together with signals from other studios, network line, or outside points. In practically any TV station setup, the supervision of the individual camera signals is exercised by the "video operator" who sits at the video console.

### Basic Audio Considerations

The audio equipment used in a television station is very much like that used in a standard broadcast station. There are, however, several minor differences. One is occasioned by the fact that microphones are usually kept out of sight and that performers must work farther from the microphones. This usually requires more microphones or the use of elaborate boom mounts (see Fig. 7).

The boom operator, under the direction of the audio engineer, maintains the placement of the boom microphones for best sound pickup. He must also keep the boom and microphone out of the view of the camera. Good communication, therefore, must be maintained between audio engineer and boom operator.

Audio switching is normally "tied-in" or interlocked with video switching. However, provision can be made to divorce the two functions, if necessary. The TV audio control operator, in addition to performing his normal job of riding gain, must maintain close following of the overall program and generally keep step with video control.

### Video Switching Considerations

The location and arrangement of facilities for video switching varies widely with

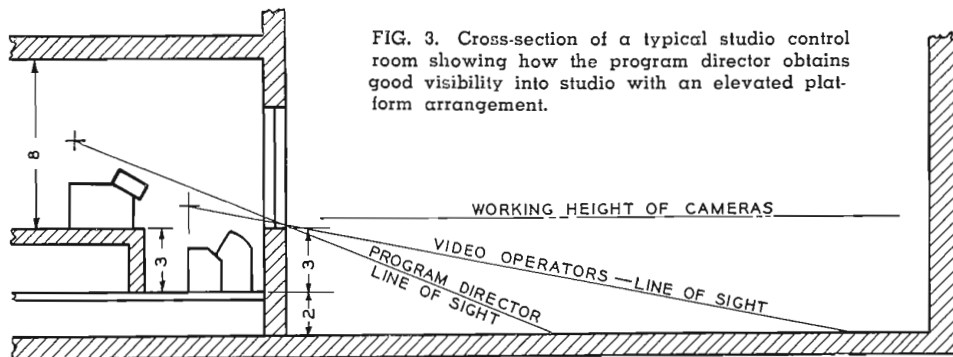

FIG. 3. Cross-section of a typical studio control room showing how the program director obtains good visibility into studio with an elevated platform arrangement.

picture monitor. It enables a commentator, for example, to see the picture upon which he is commenting. If this announce booth is to serve also for station identification, it is advisable to locate the booth so that visual "cue" may be given from the studio control console. It may be desirable on some occasions to point a camera at the announcer through the announce booth window, and this possibility has been taken into consideration in the plans of "A-Prime", "B", and "C". This has been accomplished by existing TV stations with varying degrees of success. To overcome the problem of reflections, some stations have found that the use of inclined windows contributed to improved performance, while others use non-reflective glass.

### Basic Studio Equipment Considerations

The Television Equipment units, in addition to the familiar studio and film cam-

video operator uses these controls to keep the several camera pictures in optimum adjustment at all times. Thus, the technical director, or switching operator, is free to concentrate on the action without being concerned about the camera adjustments.

In the layouts of Plan "A" and Plan "A-Prime", a single combination audio/video console (see Figs. 4 and 5) is located in the transmitter room and provides all switching, camera control, monitoring and previewing facilities. Additional monitoring sections and camera controls may be added for future expansion. In Plans "B" and "C", separate studio control consoles are employed. However, regardless of the location of individual sections, the output of each studio or film camera is fed into one of the input positions on the TS-10A Video Switching and Fading Console (see Fig. 6). At this console position, the video

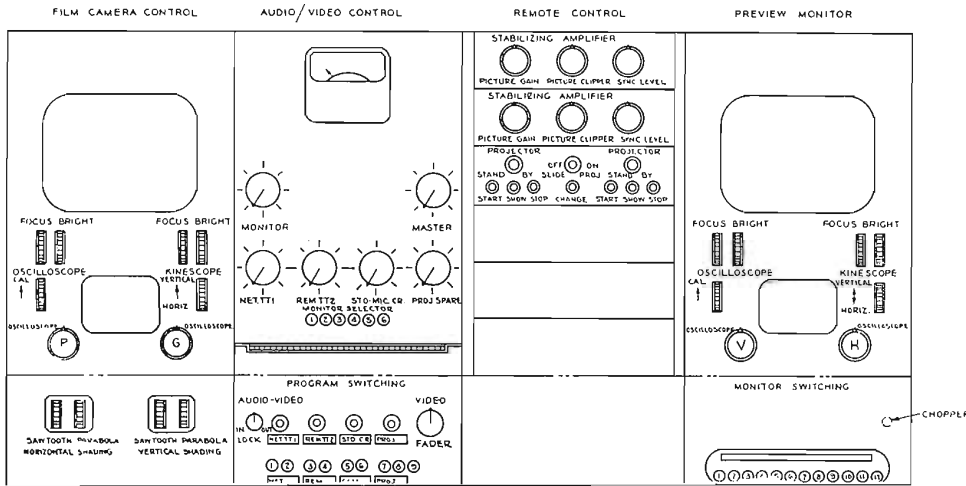

FIG. 5. Detailed panel layout showing the controls, meters and pushbuttons provided by the four console sections. Additional studio camera control and film camera control sections are added as the plans increase in size and scope of programming.

In almost any television station, it is desirable to be able to switch from local to remote and network signals in master control. A feature of the layouts described here is that remote and network signals as well as signals from other studios may also be brought into any of the camera switching systems by means of a video patch panel, thereby allowing control of all program source material within any studio control room.

### House Monitoring Considerations

House monitoring is an important function and consideration before construction begins will make a much neater installation. One simple and inexpensive method is to transmit the required signals to the several locations where there are standard re-

the type of setup (and with the personal preference of station planners). In medium-sized stations (such as depicted by Plan "B"), a simple but effective arrangement consists of adding to the video console two additional monitor sections. One of these acts as a master (or program) monitor. On its screen appears at all times the picture output of the control room. There is a space in this console for a panel containing pushbutton switches with lap-dissolve levers, signal lights, etc. The technical director uses these controls to select the picture for transmission. The second monitor is used as a "preview" monitor. The technical or program director uses a set of pushbuttons to select any of the camera inputs he proposes to use. This allows him to monitor (for quality and action) any upcoming shot. This monitor may also be used to take visual "cue" from a preceding program by switching to the video line from the preceding origination point.

The average television program consists of a succession of camera pickups, plus the occasional inclusion of signals from remote points or other studios. A simple example of the latter is the insertion, into the program, of a station identification slide or short picture sequence originating in the film projection room. Another is the occasional (although less frequent) insertion of outdoor scenes or sporting events picked up by field equipment and fed to the station by line or microwave relay. Thus, even though the major part of any one program will originate in one studio, with control of the program centered in its control room, some provision must be made for coordinated control of the remote signals, as well as control of the signals emanating from the projection room.

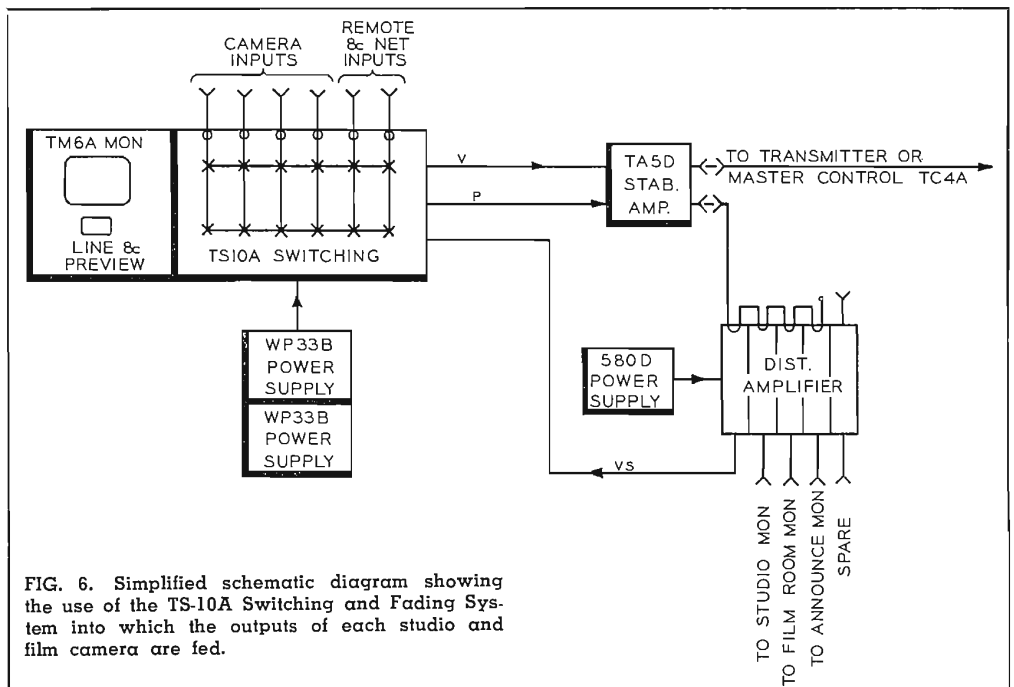
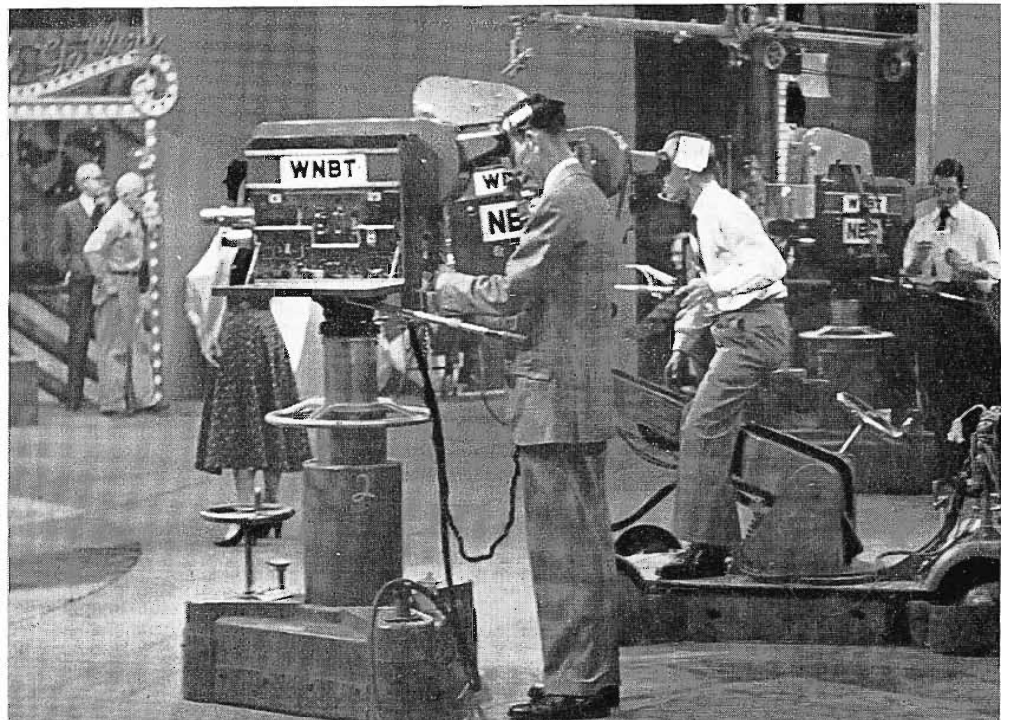

FIG. 6. Simplified schematic diagram showing the use of the TS-10A Switching and Fading System into which the outputs of each studio and film camera are fed.

FIG. 7. In good TV Audio pickup practice, the microphone must usually be kept out of sight. This requires the use of an extension or "boom-type" mike stand like those shown in layout photos to follow. The "perambulator" type shown below is another possibility for consideration in larger studios where greater mobility and manipulation are required.



ceivers. The Type TM-30A Monitran is a miniature television broadcasting transmitter intended for use in television stations to "close-circuit" feed standard TV receivers used as monitors. It develops both a picture and sound carrier on any one of the twelve VHF television channels.

### Lighting Considerations

In general, the two main classes of lighting considered are: (a) lighting of plant operational and administrative areas, and (b) studio lighting. Both of these planning factors are described in the station plans that follow as applied specifically to each layout. Basically, the lighting system for a TV studio is determined by the architectural properties, degree of flexibility desired, nature of the program material, and by the lighting requirements (both artistic and technical) of the TV productions to be staged.

### Basic Intercom Considerations

Intercommunication and talkback facilities for a television station will be more elaborate than those required by most AM and FM stations. In even the most modestly equipped TV station, the intercom system will be called upon to perform these functions: (1) talkback (over-ride, carrying cue or orders to studio, projection room and announce booth—a function of the audio facilities); (2) Order-Wire (telephone facilities to offices and to outside lines); (3) *Headset Intercom* (to provide private and conference communications for production and for technical personnel).

Since the intercom requirements of the individual stations will vary considerably, the plans that follow include diagrams and descriptions that apply to each station.

### General Size Considerations

It will be noted from the floor plans to follow that, wherever economically feasible some space allowance has been made for incorporating transmitters of several different power ratings. However, when considering transmitters larger than those indicated, the planner should *be sure to provide the additional space*.

It will be noted that sideband filters or diplexers are ceiling mounted to conserve floor space, and that the engineer's desk can be conveniently moved to general office areas to provide space for accommodating a VHF or UHF 10-KW transmitter. Some additional space for mounting associated components and/or power equipment is

also available in the engineering workshop or heating and ventilating room (see Plan "B"). On the other hand, Plan "B" would not be suitable for a 25-KW or 50-KW transmitter—unless associated rectifier, power and control equipment could be located on a basement floor or elsewhere.

Another suggestion is to compare the sizes of doorways to those of individual components to *assure entrance of such items as transmitter cubicles and Filterplexers*.

In general, the planner should consider carefully both his present and future space needs and balance this with his planned expenditure. Usually, the provision of a little extra space will be more than repaid by the ease with which later expansion can be made.

### "Ductwork" of "Trench" Planning

The careful planning and layout of wiring trenches or ducts is essential to every station planner, once the amount of technical equipment has been determined accurately. It is practical to plan "trench runs" to accommodate the future addition of console sections, equipment racks and transmitter cabinets. A typical transmitter and console ductwork diagram is shown in Fig. 8 for reference, but no attempt is made in this article to illustrate complete station duct layouts. This is deemed as a consideration, unique for each station, and is perhaps best jointly solved by the station engineer, a qualified systems consultant, and the TV equipment engineers involved.

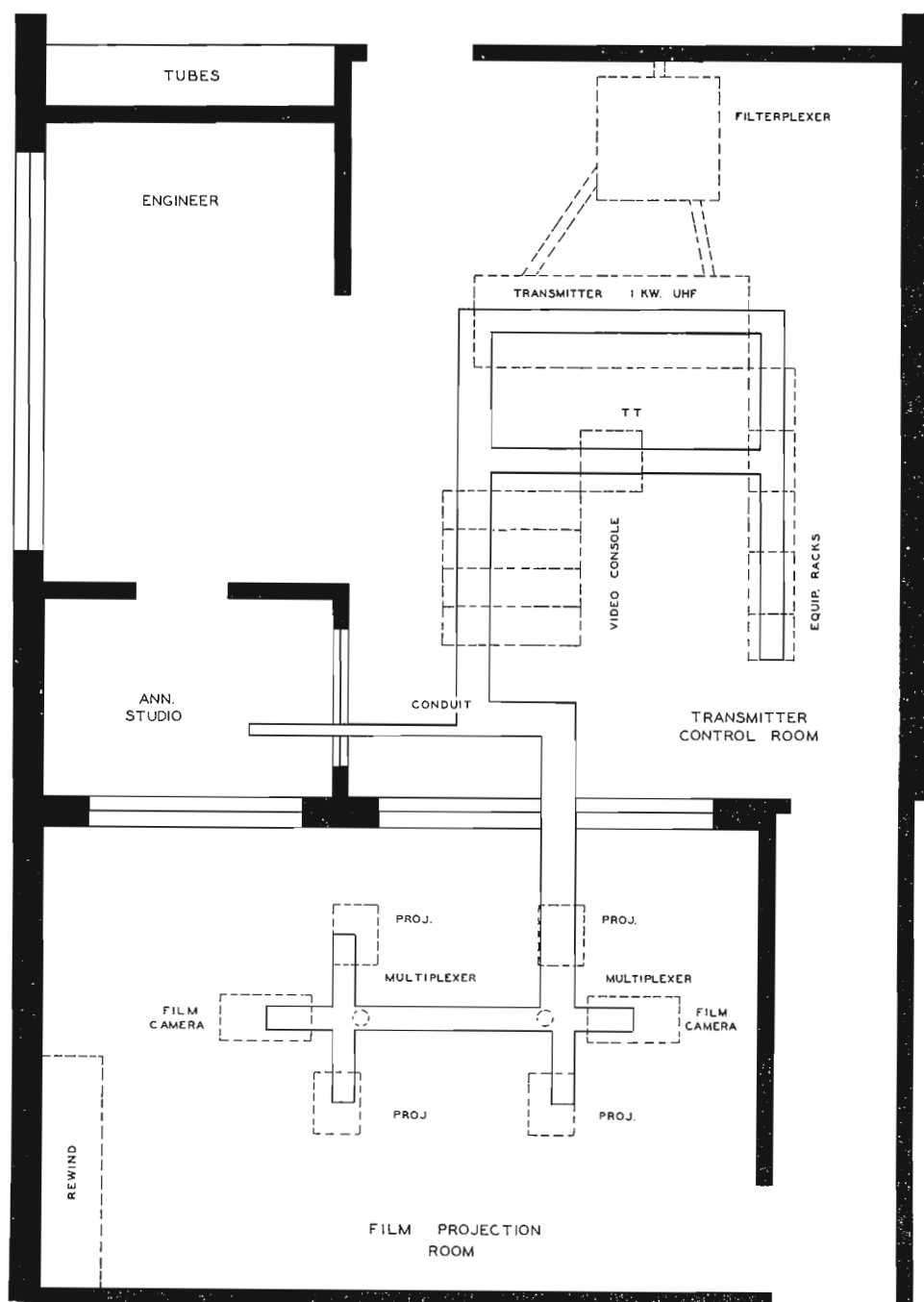

FIG. 8. A sample transmitter, rack and console duct layout. Practical planning should make provision for possible future addition of racks, console sections and transmitter cabinets.

# TV STATION PLAN "A" (Network and Film Only)

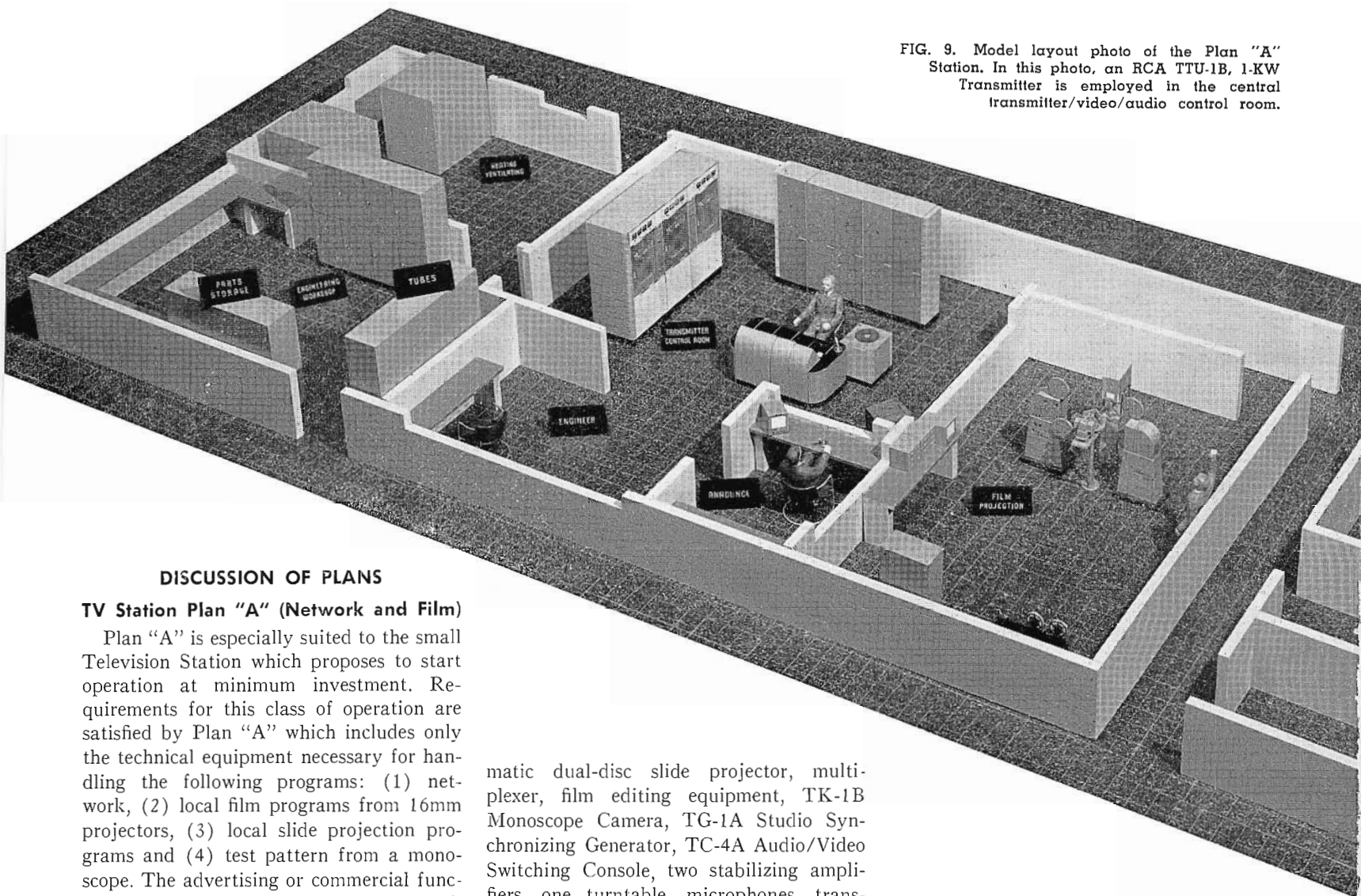

FIG. 9. Model layout photo of the Plan "A" Station. In this photo, an RCA TTU-1B, 1-KW Transmitter is employed in the central transmitter/video/audio control room.

## DISCUSSION OF PLANS

### TV Station Plan "A" (Network and Film)

Plan "A" is especially suited to the small Television Station which proposes to start operation at minimum investment. Requirements for this class of operation are satisfied by Plan "A" which includes only the technical equipment necessary for handling the following programs: (1) network, (2) local film programs from 16mm projectors, (3) local slide projection programs and (4) test pattern from a monoscope. The advertising or commercial function can be of either local or network origin.

### General Facilities

Overall housing facilities of Plan "A" include Sales, Administrative, program offices and storage space, in addition to the space provided for the technical operation (see Figs. 9 and 10). Floor space for technical equipment is separated into: a combined transmitter and video control room, announce booth, film projection room, film editing and storage, engineering workshop and parts storage, and heating and ventilating.

Major items of the equipment required to perform programming operations consist essentially of a Type TK-20 Film Camera Chain, TM-6A Master Monitor, two TP-16, 16mm Film Projectors, an auto-

matic dual-disc slide projector, multiplexer, film editing equipment, TK-1B Monoscope Camera, TG-1A Studio Synchronizing Generator, TC-4A Audio/Video Switching Console, two stabilizing amplifiers, one turntable, microphones, transmitter, antenna, audio equipment and miscellaneous accessories such as rack mounted power supplies, etc. A pictorial diagram illustrates the major equipments incorporated in Plan "A", and accompanying floor plans and "exact-scale" model photos show their approximate location. Video power supplies, distribution amplifier, stabilizing amplifiers, monitoring equipment, sync generator, audio equipment and test equipment are housed in five standard cabinet racks located near the console (see Fig. 12).

### Transmitter and Antenna Equipment

The choice of transmitter, antenna and transmission line will, of course, depend upon the individual station's power and frequency requirements (UHF or VHF).

All other items included in Plan "A" remain the same for any "A" type TV Station, regardless of power.

In Plan "A", the transmitter is located in the central control room at the right of Audio/Video control console (see Fig. 12). Transmitter test and monitoring equipment required to fulfill FCC requirements are mounted in equipment racks behind the control console. The "Filterplexer" (a combination sideband filter/diplexer) is ceiling-mounted to conserve floor space. Plan "A" indicates the use of a 1-KW transmitter (RCA TTU-1B) or a 2-KW transmitter (RCA TT-2AL/AH). However, Broadcasters planning to increase to 10-KW later on with "add-on" amplifiers may do so by moving the engineer's desk into another office, thus providing the extra

space. Either the 1-KW UHF transmitter or the 2-KW VHF transmitter and a high-gain antenna will provide powers up to 20 KW, ERP. The 10-KW transmitters and a high-gain antenna will provide Effective Radiated Powers of up to 100 KW for VHF and up to 200 KW for UHF.

**The Plan "A" Centralized Console**

Smooth and successful performance of this console is made possible to a large extent by the proper grouping of important controls to make them easily accessible to the operator. This is accomplished by using TC-4A Audio/Video Switching Console (which consists of two console sections) plus one film camera and one switchable TM-6A Master Monitor also mounted in standard console sections. These four standard sections are arranged "in-line" (with the TC-4A sections

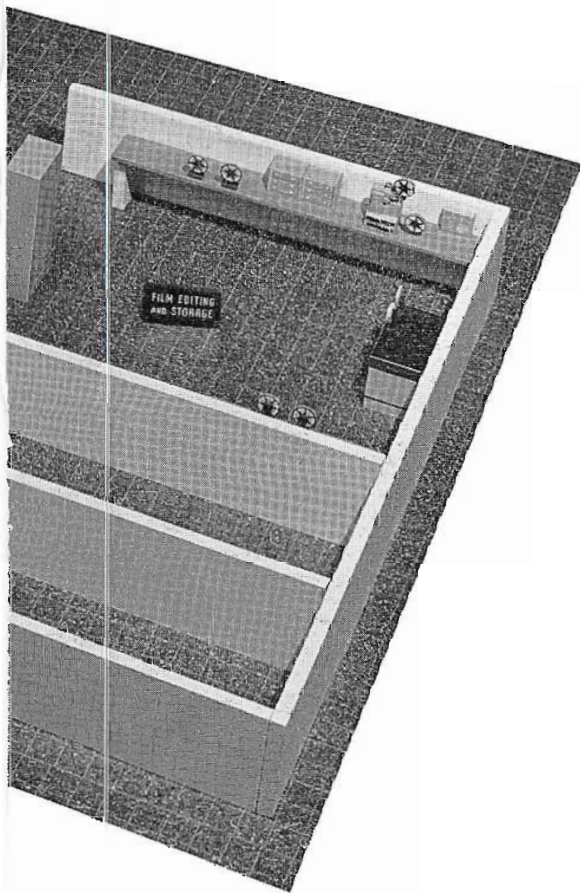
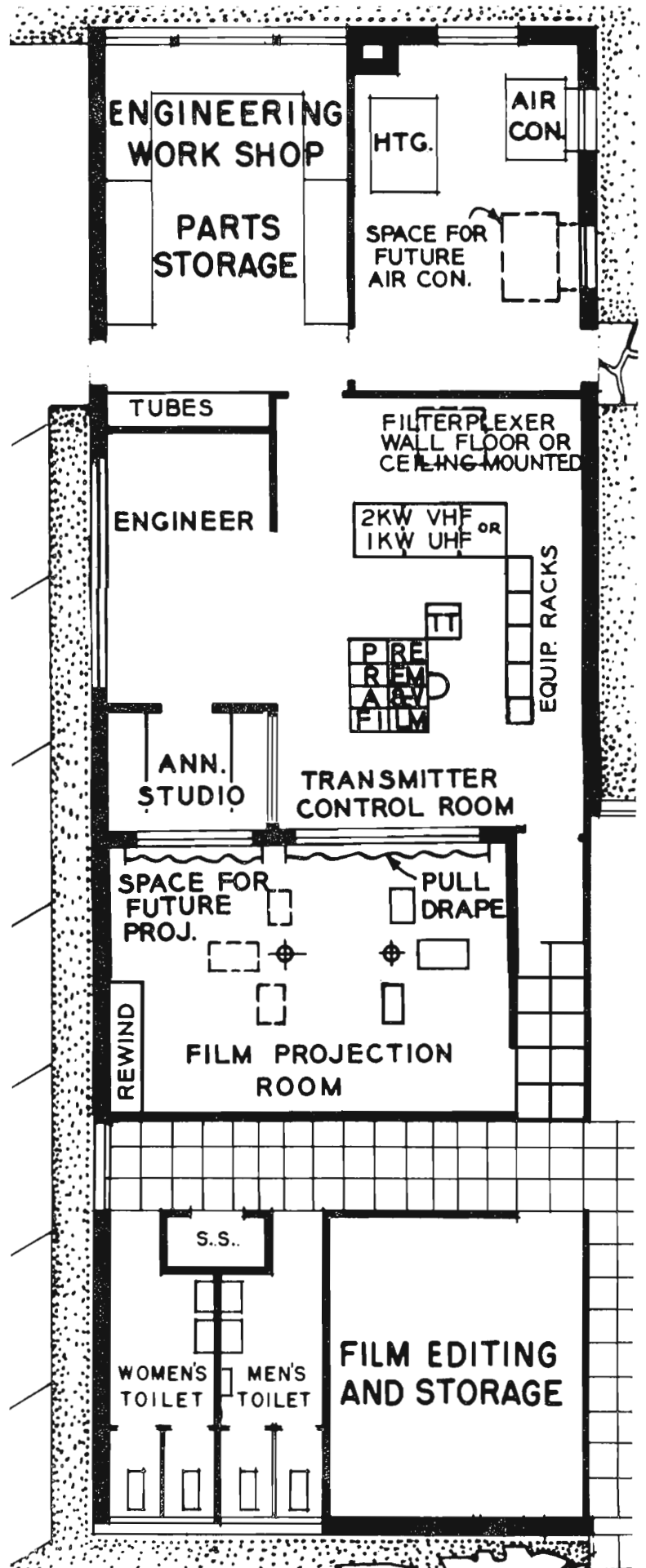

FIG. 10. Corresponding floor plan showing the technical facilities for the PLAN "A" STATION.

in the center) to form the simple unified console of Plan "A" (see Fig. 4). This console is coupled with a film camera control and forms the nucleus of a complete Television operation. It may be used by small and large stations alike, as is described later. The section at the extreme left of the console (see photo and panel layout) houses the film camera control unit. In the upper part of this console section is a TM-6A Master Monitor which has a ten-inch picture tube and a five-inch CRO tube. In the lower portion of the housing is the film camera control chassis. It supplies the blanking and driving signals to the film camera and reproduces a picture generated by the film camera. Controls for the adjustment of picture levels and shading are located on the sloping desk panel of this console section. The film camera control is located at the left end of the TC-4A Console for convenience of operation. However, the unit



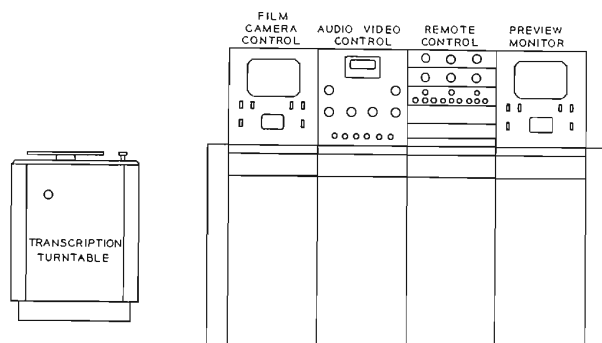
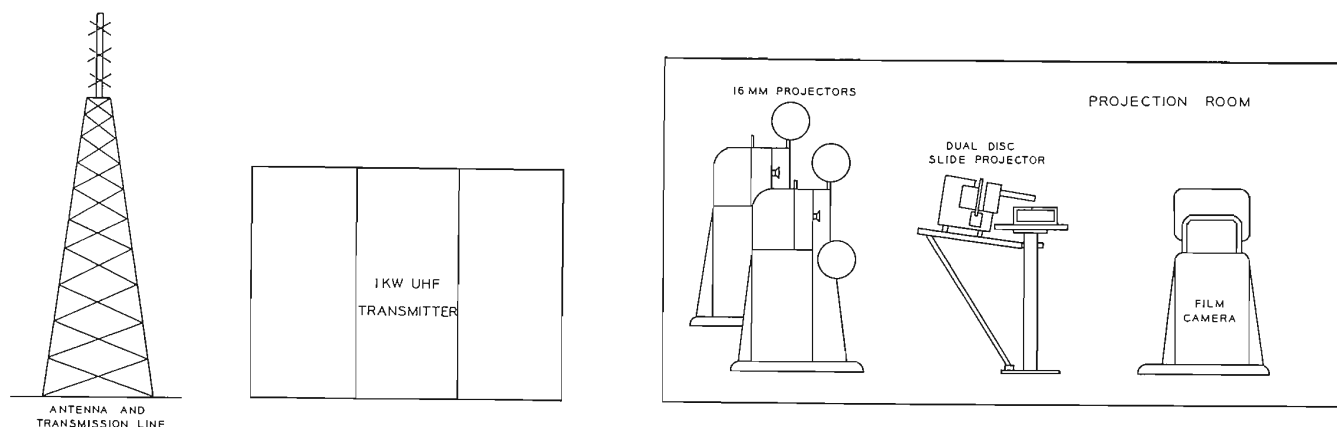

FIG. 11. Pictorial sketch showing the major items of equipment used in the Plan "A" Station which is a "film and network only" operation.

1	2	3	4	5
WP33B POWER SUPPLY (FILM)	WP33B POWER SUPPLY (MON.)	GR-1183 FREQ. & MOD. MONITOR EQUIP. VISUAL & AURAL IN TOP 3 PANELS	SYNC.  GENERATOR  TYPE- TG-1A	580-D POWER SUPPLY (STAB. AMP)
WP33B POWER SUPPLY (FILM)	BLANK PANEL VIDEO JACKS BLANK PANEL BLANK PANEL	GR-1170-BT FM MONITOR		BLANK PANEL
BLANK PANEL MI-26525-8	MONOSCOPE CAMERA	GR-1176-AT VIS. FREQUETER		BX-1E ; BA-13A PRE-AMP; LINE P.S. 1 AMP
BLANK PANEL MI-26525-8	STAB. AMP. (LINE)	GR-1171-AT FREQ. MONITOR		BA-6A LIMITING AMP.
580-D POWER SUPPLY (MONOSCOPE CAM)	STAB. AMP. (NET)	GRATING GENERATOR		B.P. MI-4590-A
580-D POWER SUPPLY (DIST AMP)	DISTRIB. AMPLIFIER	580-D POWER SUPPLY (LINE S.A.)		BA-11A PRE- AMPLIFIERS
		BLANK PANEL MI-26525-8		16MM SOUND EQ.
		BLANK PANEL		BA-14A AUDIO MON. AMP
		BLANK PANEL		BX-4A RELAY P.S.
		BLANK PANEL		BLANK PANEL MI-4594-B

may be removed from this position if desired, and placed at another location without disturbing the functions of the remainder of this switching console.

### TC-4A Sections

The TC-4A equipment is composed of the two center sections of the operating console and provides audio and video controls and audio monitoring facilities. All major console control panel circuits are brought out to coaxial and plug connectors at the rear or bottoms of the panels to provide access for test, wiring or maintenance.

The two center console sections that comprise the TC-4A Console, reading from left to right, are:

1. Audio control with combined Audio/Video program switching.
2. Remote control section.

On the sloping portion of the Audio/Video section (second from left) (see photograph) are located the program switching controls composed of one row of key switches for Audio control, one row of pushbuttons for Video control, a Video clip-fader control and a tie-switch for combining Audio and Video switching, controlled from the Video pushbuttons.

The combined Audio/Video switching is obtained by using relays. This system pro-

vides for eight inputs of Audio and eight of Video with one output for each.

### Plan "A" Audio Control

The Audio portion provides for eight inputs to four mixer positions. Audio key switches provide means of selecting any input such as turntable, projector, studio, remote or network. The inputs are relay operated so they can be controlled by the Video selector switch when desired, simplifying the Audio/Video combination switching (actual circuits are kept apart thereby preventing crosstalk). The relays are also interlocked to prevent accidental doubling of the circuits. A selector switch allows a monitor amplifier and speaker to check most of the Audio circuits including transmitter input and output, and turntable cueing. It is visualized that a separate cue-

ing amplifier and speaker may be used in most applications.

One rack of equipment houses the pre-amplifiers; program monitor, and limiting amplifiers; and power supplies. Jacks are provided for all amplifier inputs and outputs.

### Plan "A" Video Control

The Video pushbuttons also provide a means of selecting any one of eight signals, such as film, studio, monoscope, remotes or network for transmission. In addition, by using the "lock-in" switch on the left side of the panel, certain Audio and Video signals may be switched simultaneously by means of the Video pushbuttons. When switching from local to remote or network signal, contacts on the switches provide automatic removal of the local synchronizing signal.

On the right side of the switching panel is a remote "clip-fade" control. By means of this control, the signal may be faded to black, at which time an instantaneous switch may be made to a new signal, and then the new signal faded up, thus letting "roll over" occur during the black period, when switching from local to "remote" or "network".

LEGEND
D.A. - DISTRIBUTION AMPLIFIER
STAB. AMP.-STABILIZING AMPLIFIER
H. DR.-HORIZONTAL DRIVE
V. DR.-VERTICAL DRIVE
BLK. - BLANKING
S — SYNC.
DR. - CABLE CONTAINING DRIVER & BLANKING PULSES
V — VIDEO
P — POWER
VS — VIDEO SYNC (COMPOSITE)
<—> VIDEO JACKS
o TERMINATION



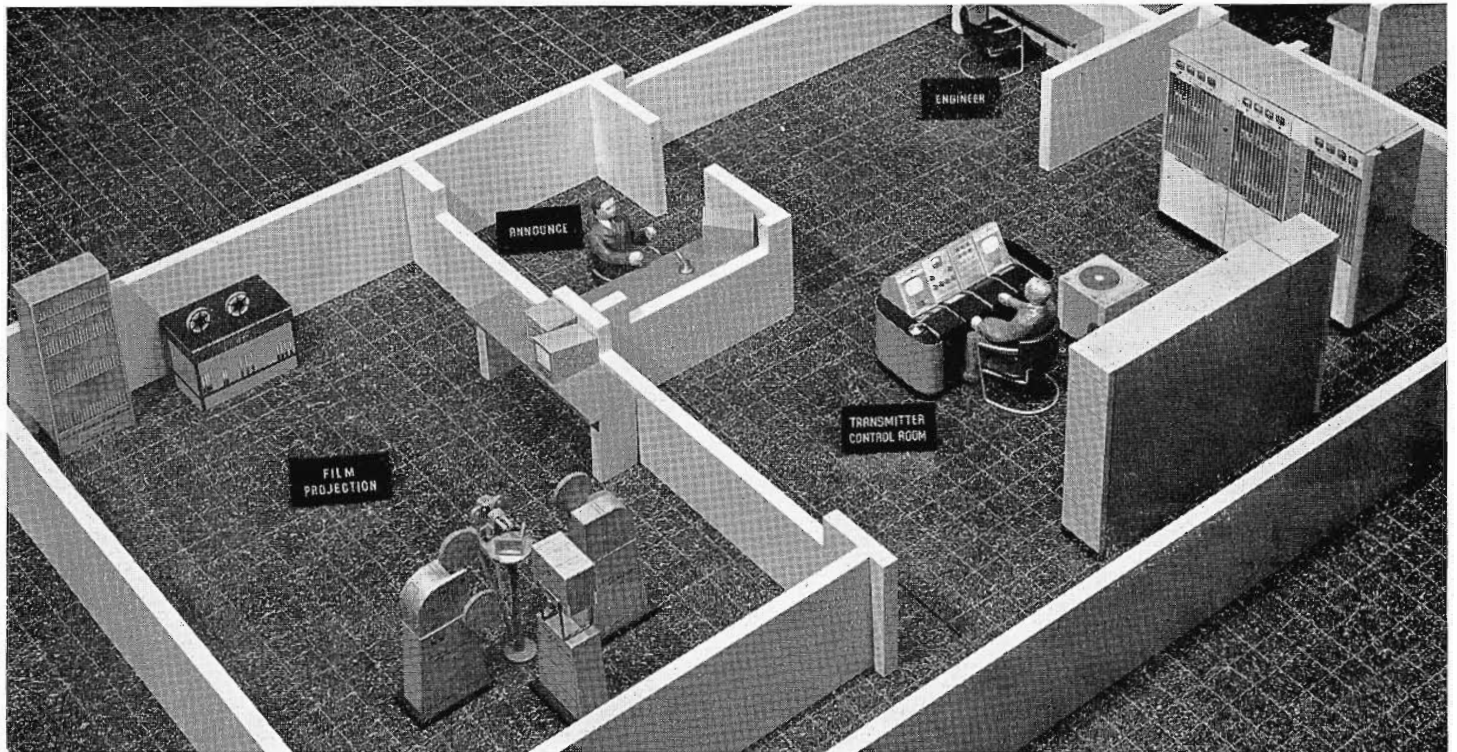

FIG. 12. Closeup photo showing the film projection room and transmitter control room of Plan "A" with the RCA 1-KW UHF Transmitter. Note space available for addition of another Film Camera Chain, when desired.

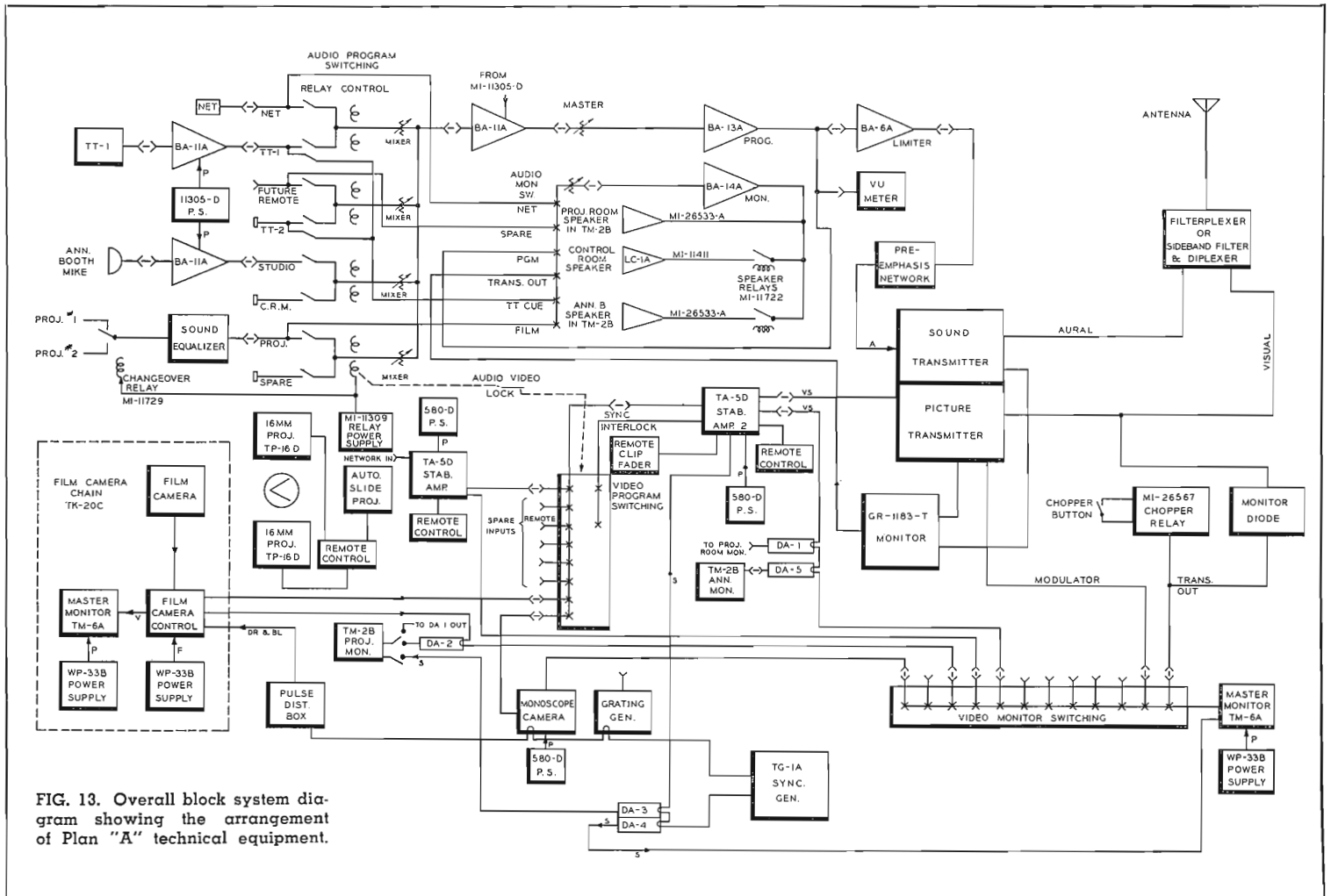

FIG. 13. Overall block system diagram showing the arrangement of Plan "A" technical equipment.

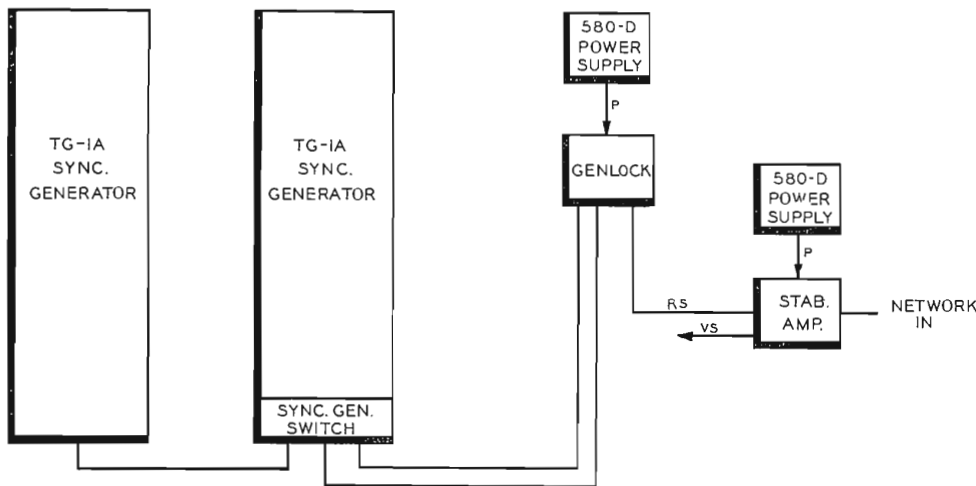

FIG. 14. Where lap dissolves or superpositions are considered essential, the TS-10A Switcher and Fader can be added as a fifth section to the central console. However, plans should also provide for the addition of the associated equipment illustrated above, except the (already available) Sync Generator at the extreme left.

Lap dissolves or superpositions cannot be made with this arrangement. However, with the flexibility of the unit-type construction, necessary equipment to accomplish this type of programming may be added. (See Fig. 14.) This would include the addition of a studio sync generator, sync generator switch, genlock and 580-D power supply, in addition to a fifth console section to house the TS-10A switcher and fader. This also applies to use of this equipment for Plan "A-Prime".

#### Remote Control Section

The other section of the TC-4A (third from left) houses all the remote controls that are necessary to provide finger tip operation of those equipments that are necessary for simple basic programming.

The two top panels control the stabilizing amplifiers. One of these amplifiers is

for network or remote signals and the second is for controlling any signal to the transmitter. The second stabilizing amplifier is also used for mixing the "sync" and local Video signals, since some form of local signal is necessary for advertising purposes. The third panel in this section is the projector switching control. Three groups of pushbuttons and tally lights are located on this panel. The groups at either end composed of three buttons and a separate lamp are identical while one pushbutton and toggle switch are located in the center. The center toggle switch is for turning the power on and off a slide projector. The pushbutton directly under the switch has a tally light built in and may be used to switch slides in the slide projector.

The tally light at the top of the panel at either end indicates when control has been transferred from the film projector to this

remote operating position. The pushbutton on the left of the group is used to start the projector and has a built-in tally light to indicate that the machine is running. The center button of the group with built-in tally light is for transferring sound and picture from one machine to the other, when two film projectors are used. The third button is for stopping the projector, and does not have a built-in light.

Another group of buttons at the other end of the panel is identical and performs the same functions for a second projector.

Further controls may be added in the blank panel positions for additional film projectors, stabilizing amplifier, power switching, monoscope camera, etc.

#### TM-6A Master Monitor

The fourth section at the extreme right-hand end of the console contains a TM-6A Master Monitor, and on the sloping desk surface are located the pushbutton switches for monitor selection. Each switch is mechanically interlocked. Provision is made for twelve inputs and one output. This unit may be used to monitor all the necessary transmitter signals in addition to serving as a preview monitor for remotes and networks. In the normal operation, this monitor will register the line signal. The output of the switch is fed from a cathode follower, which receives its power from the master monitor associated with it. Located in the monitor switching panel, a pushbutton for chopper control is provided to select a calibrating signal for indicating percentage of picture modulation to the transmitter.

#### Plan "A" Film Projection Room

As shown in the layout photos and "A" floor plan, the film projection facilities include a TK-20D Film Camera, two TP-16D, 16mm Projectors, a Multiplexer/Automatic "Dual-Disc" Slide Projector and a Utility Monitor. The Multiplexer/Automatic "Dual-Disc" Slide Projector is on a common mounting to assure best operation (see Fig. 15).

In both the "A" and "A-Prime" plans, TP-16D projectors are illustrated; however, stations may employ the TP-6A Professional Projector, where extensive film programming dictates the services provided by this type projector. The TP-6A is equipped with additional control features and larger 4000-foot reels. (See Plan "B".)

FIG. 15. A film projection room layout in which two RCA, TP-6A Professional Projectors are employed to provide additional control features and larger 4000-foot reels. Note in center (opposite the film camera) the use of the dual-disc slide projector. This photo also shows the optional use of an RCA 2-KW, VHF Transmitter, and the BQ-1A Fine Grove Turntable.

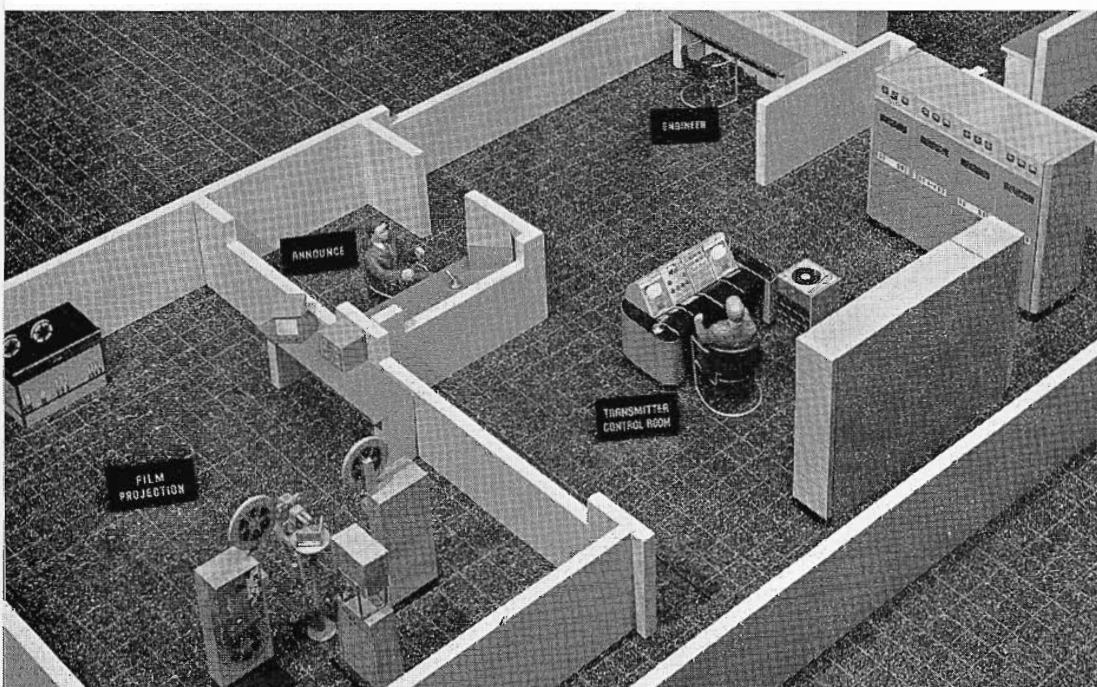

Control of the projectors is extended by use of a projector control panel located at the centralized "transmitter room" console. Complete provision is made for station breaks and spots during network hours.

Windows provide visibility into the transmitter control room and announce booth, in the event visual cue is desired. Pull drapes are shown so that "darkened room" operation may also be accomplished, since the operator at the central console has program switching control and complete film monitoring and talkback facilities.

Space is provided for a rewind bench and storage cabinet in the projection room. Since film programming will make up a large part of the station activity, space is provided for the future addition of a duplicate film projection setup. This would also require the addition of a second film camera control section to the main console in the transmitter room. Some planners may elect to start with a dual setup. Another possibility is the addition of a "Telop" projector and a second film camera for the handling of "opaques" and other program material mentioned later.

#### Film Editing and Storage

A separate room provides space for film accessory equipment to accommodate film handling, editing and storage needs. Some stations, because of expanded film programming, may find a need to enlarge these facilities. As previously mentioned, part of this equipment is installed in the film projection room for convenience in handling daily shows. An approximate equipment list for Plan "A", representing minimum requirements, is shown below:

- 2 film splicers
- 1 pair rewinds
- 1 measuring machine
- 1 small viewer
- 1 or 2 editing tables or benches
- 4 2x2-inch slide file cabinets
- 1 open face rack for large reels aired daily
- 1 permanent type storage cabinet
- 12 2000-foot flat steel reels
- 12 1600-foot flat steel reels
- 12 400-foot flat steel reels
- 50 100-foot flat steel reels
- 1 14-inch steel rewind flange DAF-26
- 1 small screen preview projector
- 1 34x50-inch screen on tripod or wall mount.

Space requirements for handling film may vary; however, room should be provided for editing, splicing, rewinding, commercial insertion and storage for both "daily and upcoming" shows that are to be aired. The editing area will also be needed to accommodate last minute "hurry-up"

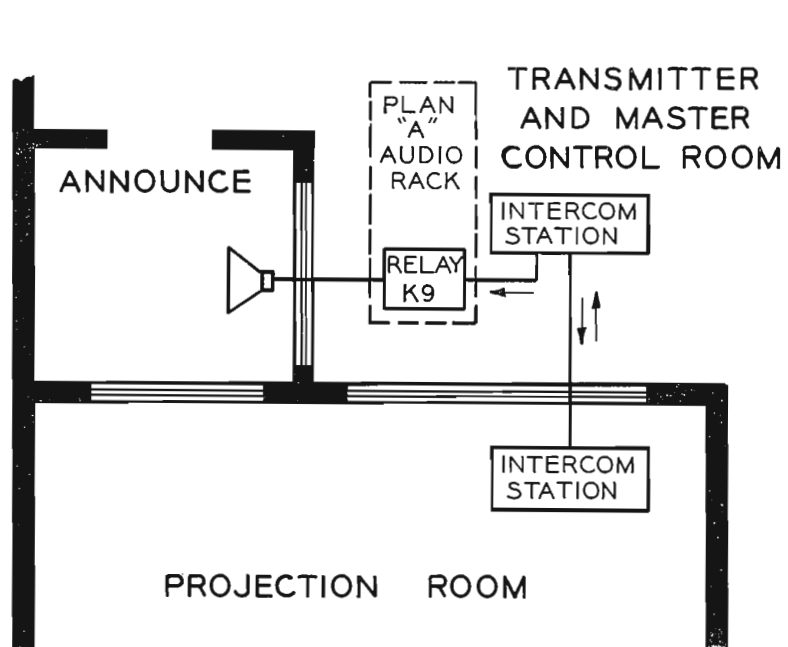

FIG. 16. Diagram showing the provision in Plan "A" for intercommunication facilities.

changes so frequently encountered in the preparation of film for airing.

#### Plan "A" Intercom

The transmitter or master control room operator should have continuous two-way communication with the projection room and talking facilities only to the announce booth (see Fig. 16).

During "on-air" announce periods, the announce booth intercom speaker is automatically muted by utilizing available contacts of the announce booth speaker muting relay (K-9).

#### Plan "A" Lighting

Since the station of Plan "A" does not include a studio for live pickups, only the lighting of the operational and administrative areas is required. In general, the two kinds of lighting for such areas are task light and general light.

General lighting provides the required average level of light for the overall lighting of each room. In control, traffic and office areas, this lighting reduces eye strain and discomfort caused by looking at strong contrasts between light and dark areas. By the proper choice of wall and ceiling fixtures, the general lighting can enhance architectural features. Fluorescent fixtures can efficiently light office areas and provide at least 30 foot-candles of incident light to working surfaces, or a perimeter type of general lighting using wall valances gives a pleasing effect and can be hidden within the architectural features.

Task light is direct high light focused at the required angles and work area and is provided by recessed spots or wall, desk,

and floor fixtures in close proximity to the work area. In relation to the general lighting, the task lighting is always of greater intensity and at least 40 to 50 foot-candles are recommended.

Possibly, the most important lighting problem is found in the film and control rooms. The room's general light level should be kept at a low or medium level with indirect lighting fixtures or by use of recessed units, located so that no reflections are noted on the monitor scopes. By such lighting, the strong contrast between the TV tube and surrounding areas is prevented. To the technical personnel of the control room, this means less eyestrain and fatigue while watching the monitors. The normal routine also requires them to read scripts, check schedules, record the station log, and operate the controls immediately before them. To best facilitate this, a small spot is mounted in the ceiling above the console. The unit with a focused beam and using a 100 or 200 watt lamp should have four-way shutters to enable full beam shape control. Units of this type are made by Century or Kliegl.

Similar units can also be used in the operational areas of the film room to highlight special work functions of the film activity. Spill and stray light into the iconoscope camera is thus minimized and full concentration is afforded the lighted portions where the operator may view monitors and controls.

These considerations of general plant lighting requirements are also applicable to Plans "A-Prime", "B" and "C" and are not repeated as a part of the following descriptions of those plans.

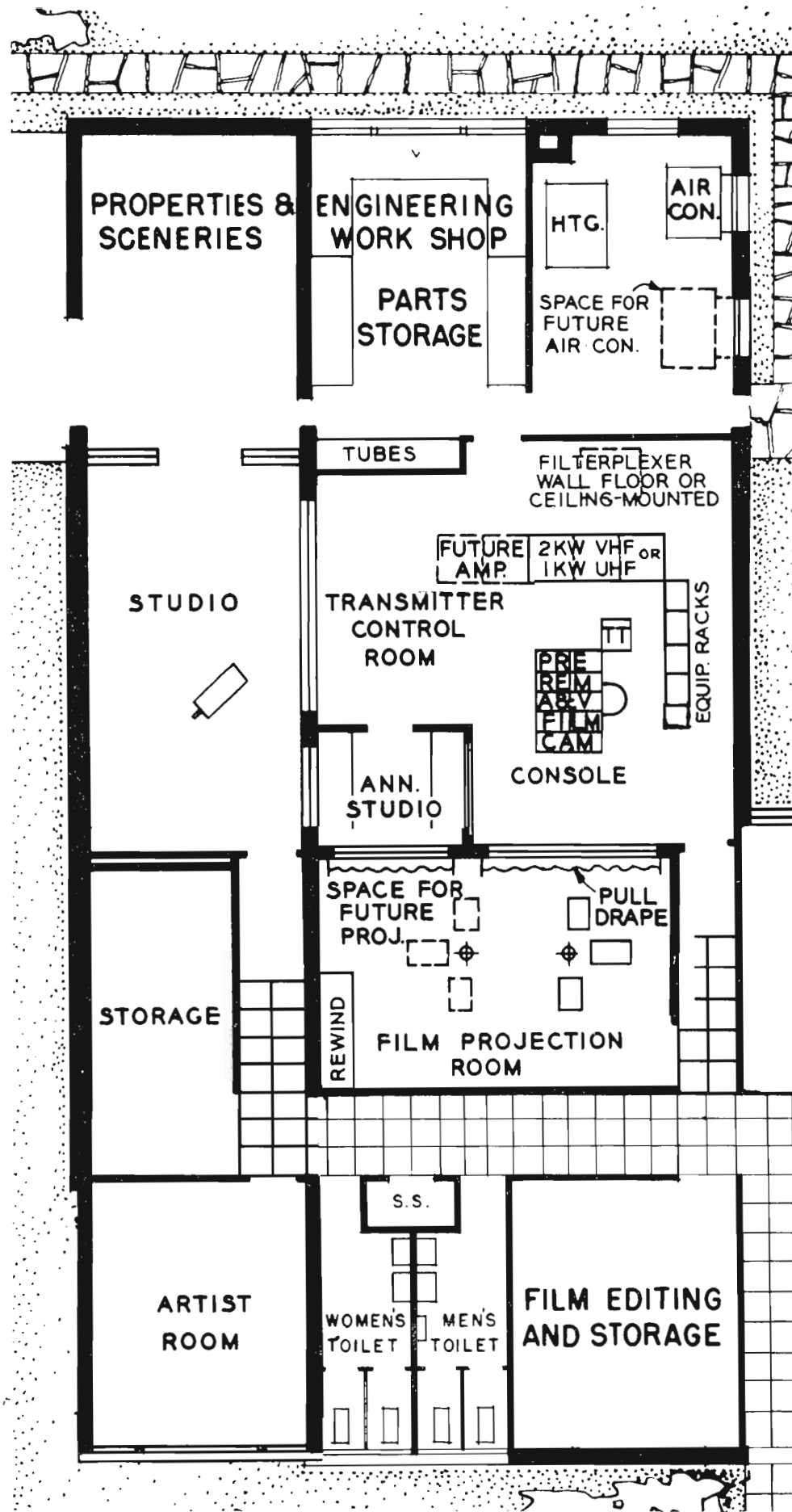

## TV STATION PLAN "A-PRIME" (Network, Film and Single-Camera Studio)

### DISCUSSION OF TV STATION PLAN "A-PRIME"

(Network, Film and Single-Camera Studio)

TV Station Plan "A-Prime" is practically identical to the "A" station, previously described. The major difference is the addition of a small "single-camera" live talent studio together with the necessary space for properties and scenery handling plus an artist's room. Additional studio

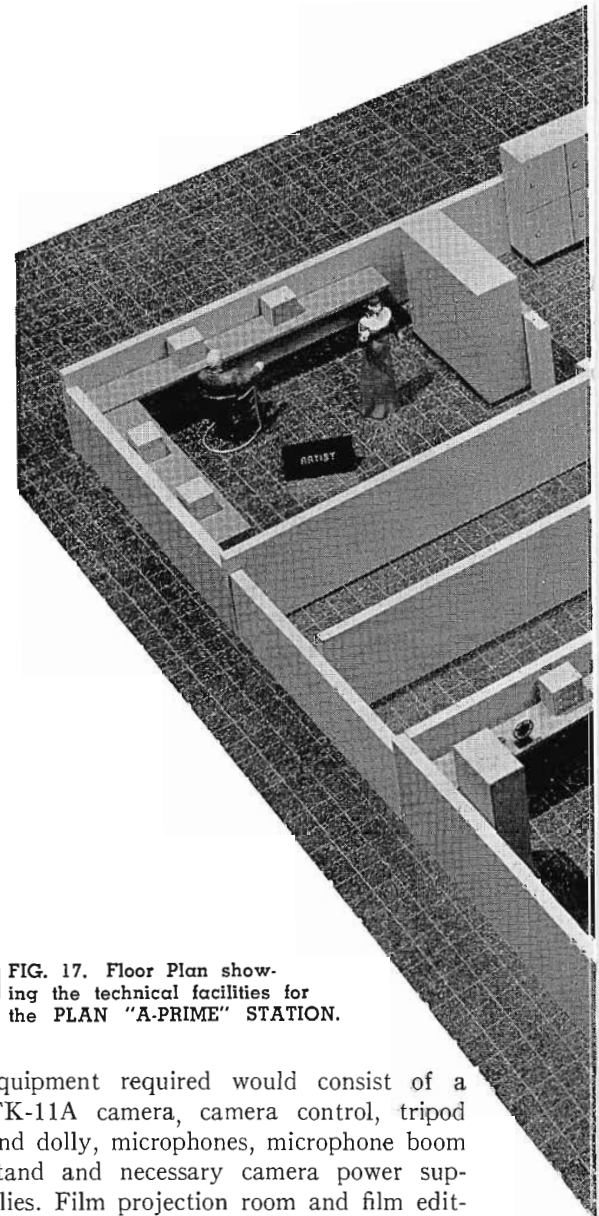

FIG. 17. Floor Plan showing the technical facilities for the PLAN "A-PRIME" STATION.

equipment required would consist of a TK-11A camera, camera control, tripod and dolly, microphones, microphone boom stand and necessary camera power supplies. Film projection room and film edit-

ing and storage facilities are the same as that of Plan "A". (See Figs. 17 and 18.)

Plan "A-Prime" is suited for a "small community" station with the possibility of future growth to a larger studio such as included in Plan "B". Expansion can be made from "A-Prime" to Plan "B" with modest alterations and modifications.

### Programming

The facilities included in Plan "A-Prime" provide all of the programming possibilities of "A" plus the handling of live pro-

grams. Thus, the following programs may be accommodated by Plan "A-Prime" (see Figs. 19 and 20):

- (1) network
- (2) local film programs from 16mm projectors
- (3) local slide projection
- (4) test pattern from the monoscope camera and

era control section to the Audio/Video console to accommodate the single studio camera. Also, it will be noted that the engineers' quarters can be moved to the office area to provide additional space. This space can be utilized by the installation of a 10-kw transmitter such as the TT-10AL/AH or TTU-10B for VHF and UHF, respectively (see Fig. 21). As in Plan "A", five equipment racks are used to house stabilizing amplifiers, power supplies, test, monitoring and audio equipment. However, if the budget permits, the installation of an extra rack will be repaid

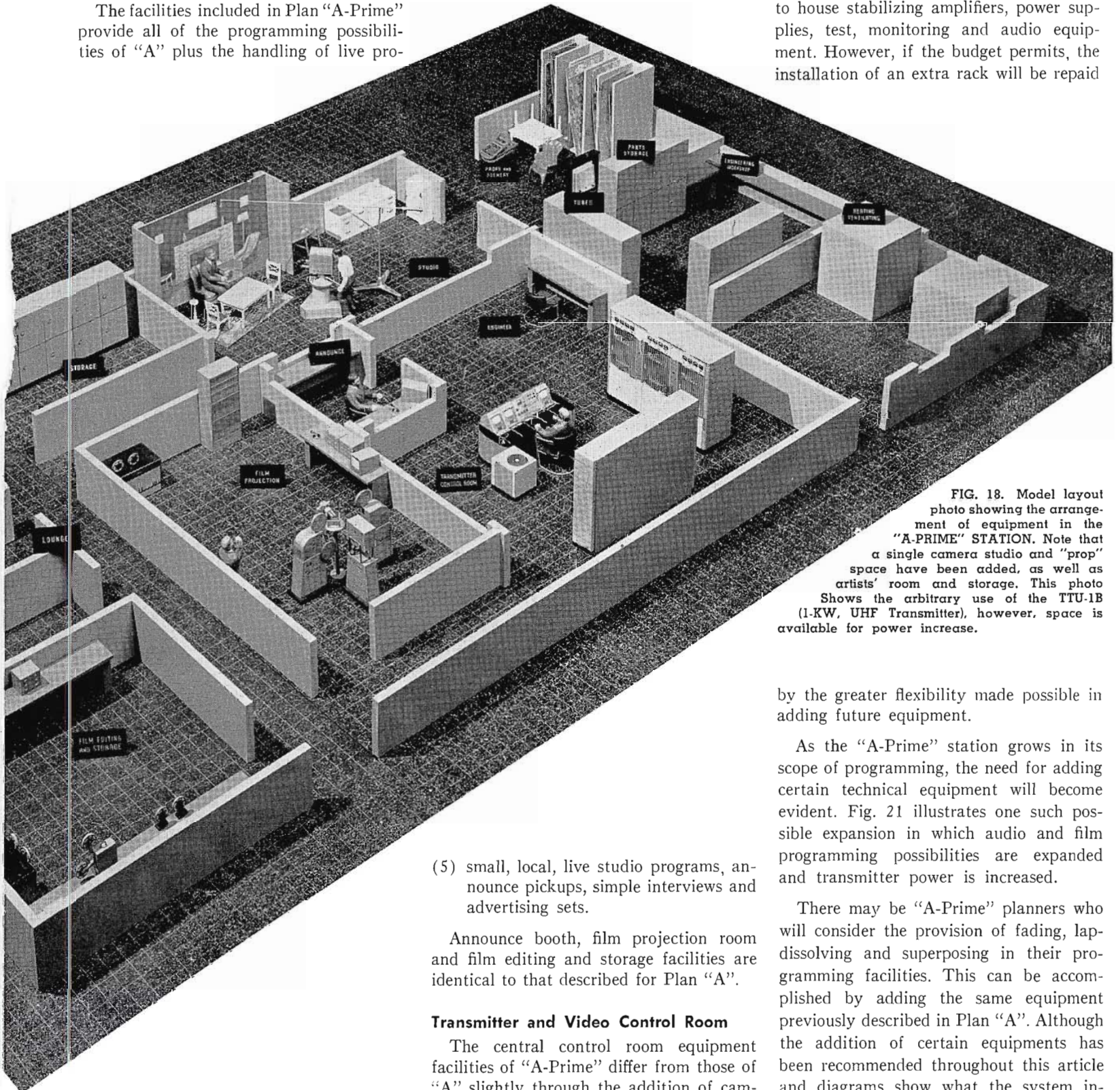

FIG. 18. Model layout photo showing the arrangement of equipment in the "A-PRIME" STATION. Note that a single camera studio and "prop" space have been added, as well as artists' room and storage. This photo shows the arbitrary use of the TTU-1B (1-KW, UHF Transmitter), however, space is available for power increase.

- (5) small, local, live studio programs, announce pickups, simple interviews and advertising sets.

Announce booth, film projection room and film editing and storage facilities are identical to that described for Plan "A".

### Transmitter and Video Control Room

The central control room equipment facilities of "A-Prime" differ from those of "A" slightly through the addition of cam-

by the greater flexibility made possible in adding future equipment.

As the "A-Prime" station grows in its scope of programming, the need for adding certain technical equipment will become evident. Fig. 21 illustrates one such possible expansion in which audio and film programming possibilities are expanded and transmitter power is increased.

There may be "A-Prime" planners who will consider the provision of fading, lap-dissolving and superposing in their programming facilities. This can be accomplished by adding the same equipment previously described in Plan "A". Although the addition of certain equipments has been recommended throughout this article and diagrams show what the system in-

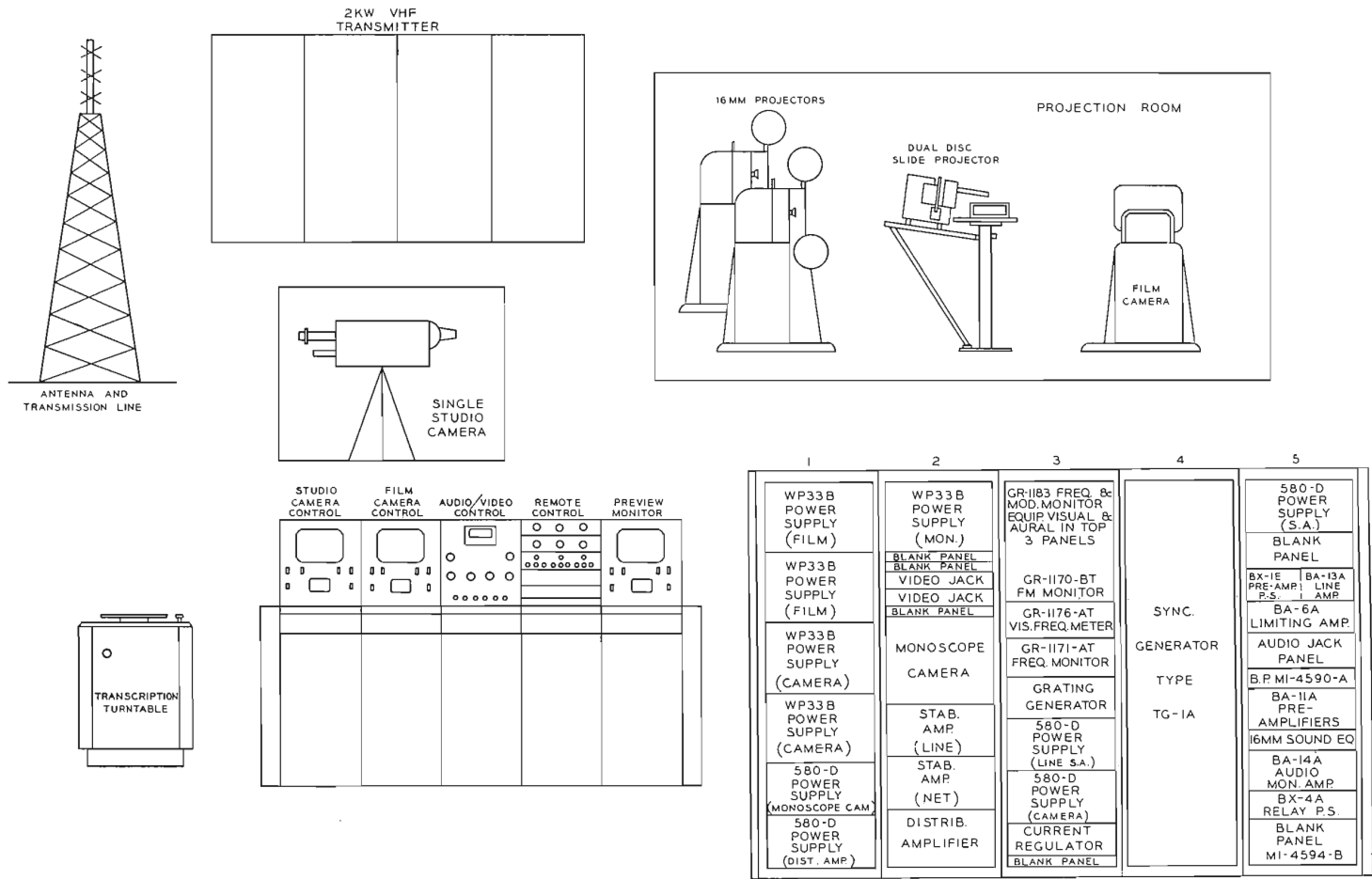

FIG. 19. Pictorial layout showing the major items of equipment required in Plan "A-Prime".

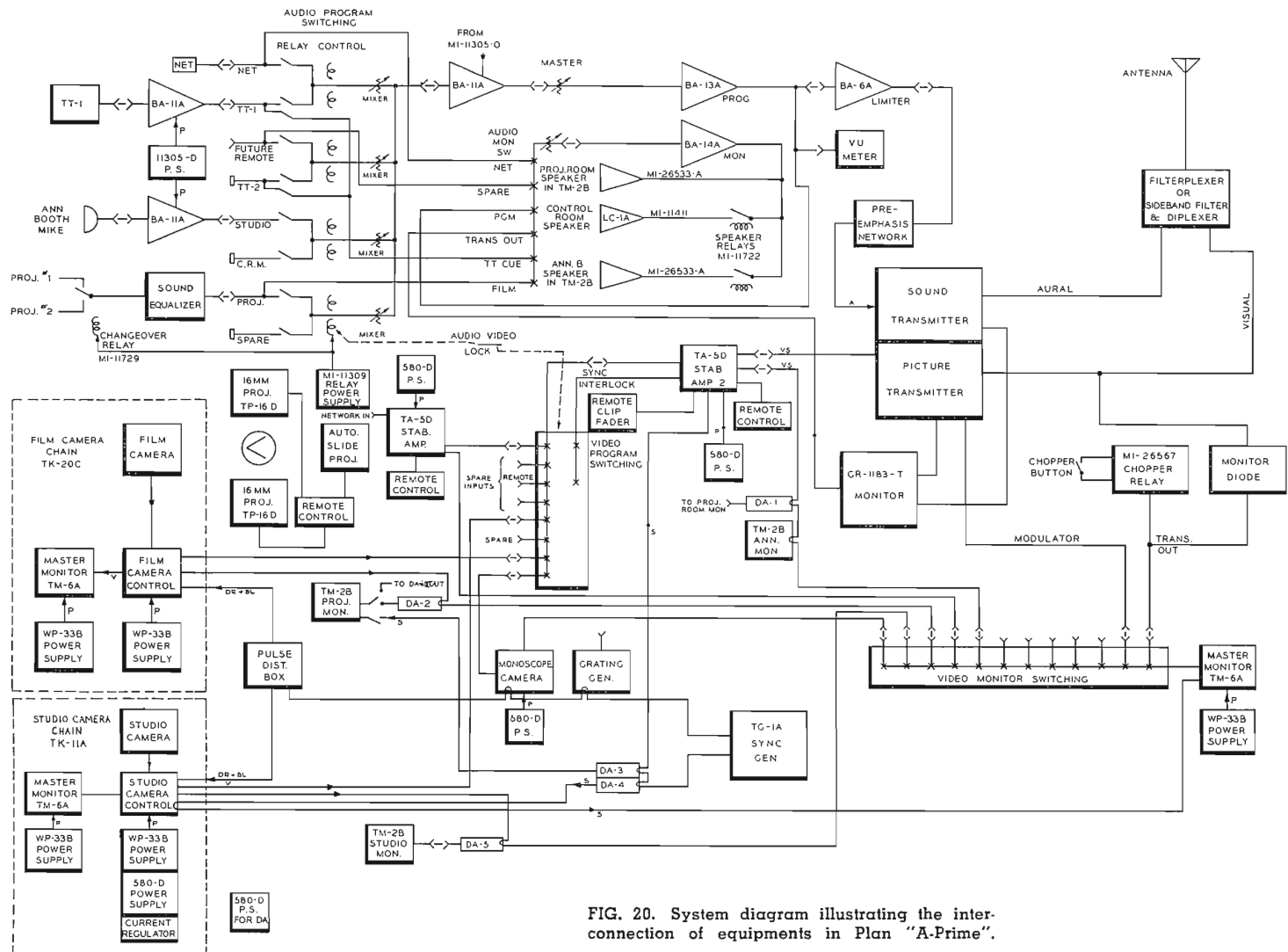

FIG. 20. System diagram illustrating the inter-connection of equipments in Plan "A-Prime".

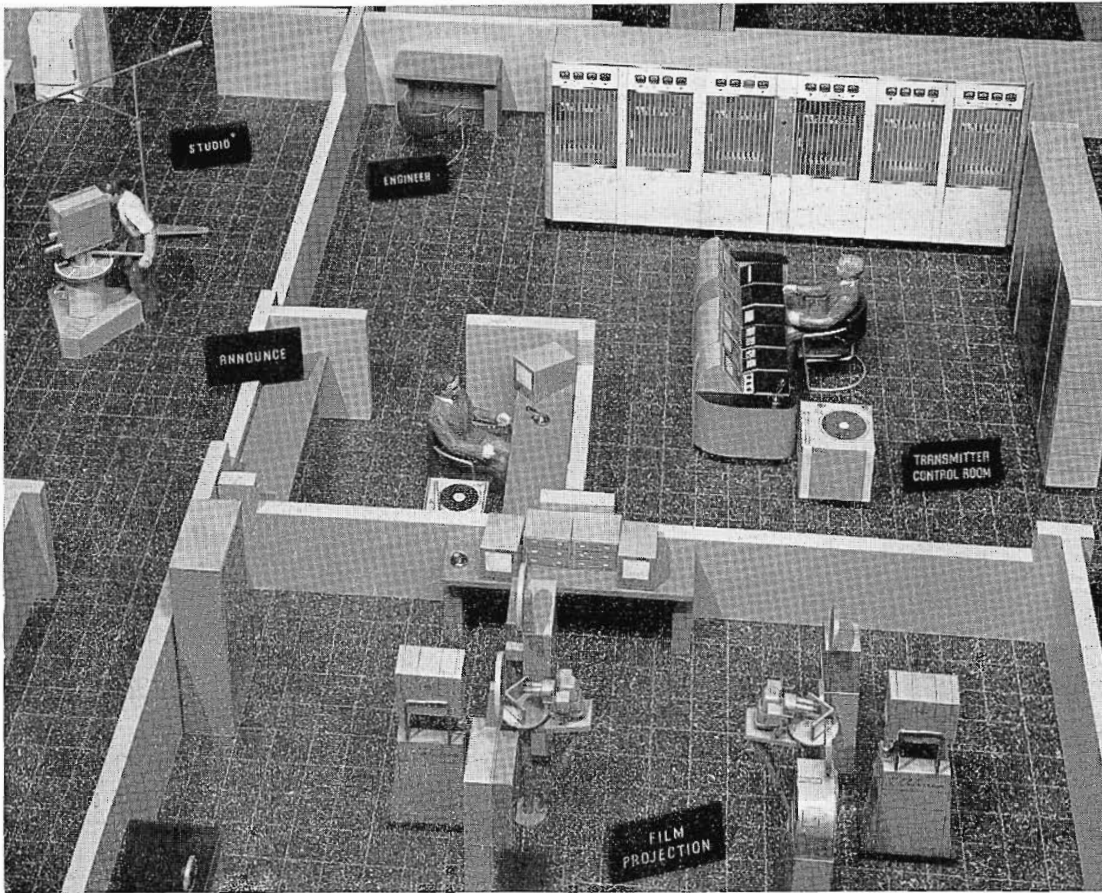

FIG. 21. Model layout of an "A-Prime" Station which employs an RCA TT-10AL (10-KW, VHF Transmitter). Note that this particular station has expanded by adding a second TP-16D Film Setup, additional TM-2B Film Monitor, and an RCA BQ-1A Fine Groove Turntable to announce booth for disc jockey shows.

cludes (as, for example, for fading and lap-dissolving or "Genlock" operation), the planner is cautioned that a system study should be made to determine if other equipment is needed to fully integrate the addition.

#### Plan "A-Prime" Intercom

In the "A-Prime" Plan, the control room operator has continuous two-way communication with the projection room and has talking facilities only to the announce booth and studio.

During "On-air" announce periods, the announce booth intercom speaker is automatically muted by utilizing available contacts of the speaker-muting relay. During "On-air" periods of the studio, its intercom speaker may also be muted in a similar manner (see Fig. 22). The camera control operator has continuous two-way "headset" interphone communication with the cameraman.

#### "A-Prime" Studio Lighting

The general and task lighting for the Plan "A-Prime" plant is the same as that described for "A". However, the lighting of the studio for best programming quality requires further consideration.

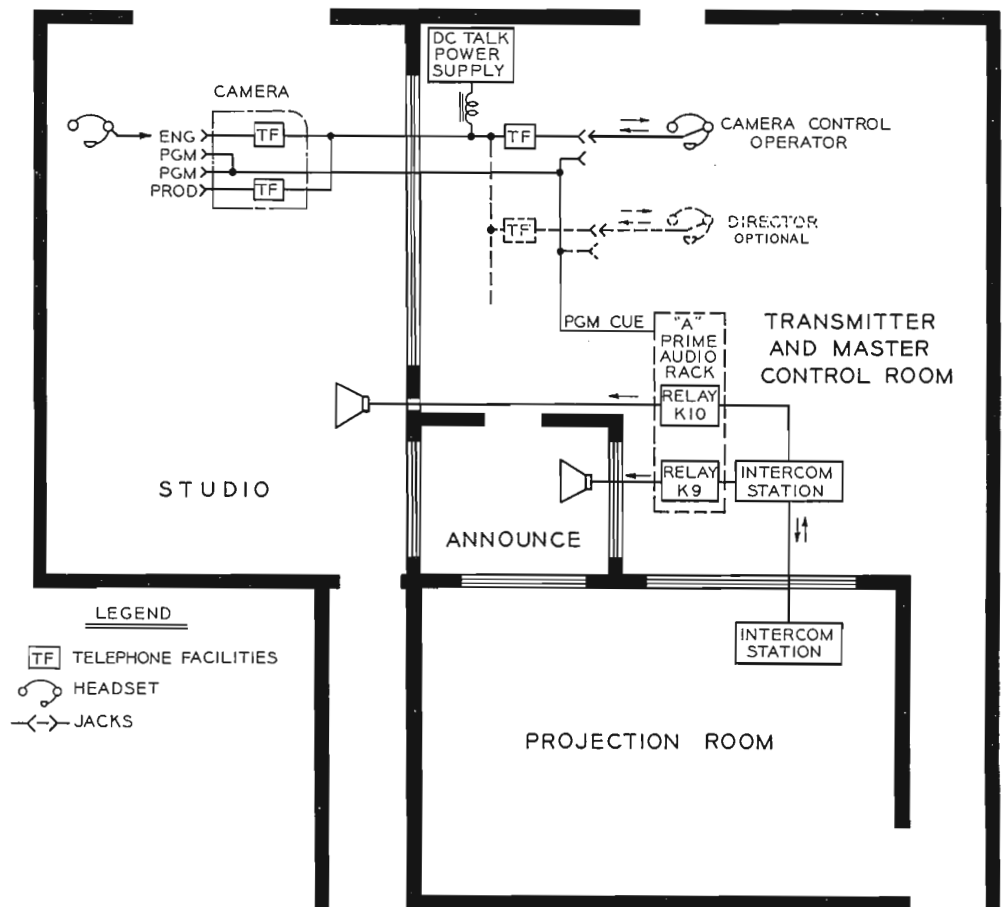

FIG. 22. "Intercom" "flow" diagram for the "A-Prime" Station.

In a studio with this plan, a single camera is provided which will undoubtedly be used for repetitive type of programming. Local, unrehearsed shows such as panel discussions, interviews, local spots, kitchen shows or demonstrations will be predominant. Although the studio is a small 16 by 26-foot unit, it can accommodate a permanent kitchen set and an office scene as suggested in Fig. 23. Space is also available for displaying the sponsor's products and advertising placards.

The lighting system for such a studio may be investigated from the standpoint of application tools, wiring and control de-

vices, and sources. The Plan "A-Prime" lighting system described is shown in Fig. 24.

#### Lighting Application Tools

Unobstructed flexibility of camera and mike boom is required on the studio floor; therefore, the lighting is done from overhead. The means of supporting the lighting fixtures is facilitated by the application tools—viz., grid-work and pantographs.

The ceiling height of 14 to 18 feet in the "A-Prime" studio prompts the use of a primary-secondary type of grid structure using 1¼-inch black iron pipe. The pri-

mary grid (pipes A of Fig. 24) is installed as close to the ceiling as possible—allowing clearance for raceways, ducts, and sprinklers. From this permanent group of parallel pipes is suspended a secondary grid, pipes B of Fig. 24. The secondary pipes are suspended by means of double "C" clamps or chain from the primary pipes and are perpendicular to them. The criss-cross network formed should be on 6- to 8-foot centers to insure adequate facilities for suspension of fixtures. The secondary pipes allow flexibility, as they can be repositioned to any point on the scene required. Normally, the resulting grid is spaced 12 to 14 feet from the studio floor. From this grid the fixtures can be hung directly, or through pantograph hangers.

Pantographs permit raising and lowering of lighting fixtures and when used with crossarms can support a number of fixtures. Current pantographs can support weights up to 60 pounds and allow for a vertical travel from 8½ to 12½ feet at maximum extensions. A number of pantographs supported from the grid have a great advantage for rapid vertical adjustment. Their most important use in the "A-Prime" studio is the support of base lights which, for best pictures, should be 8 feet from the floor.

#### Lighting Wiring and Control Devices

Mounted to the secondary pipes are three connector strips, each with 5 outlets. These outlets are pigtailed of 3- or 4-foot cables with female stage connectors attached. A total of 15 ceiling outlets are therefore provided in the studio of Plan "A-Prime".

From each connector strip, a 12-conductor cable brings the branch circuits directly, or through 4 by 4-inch duct to the studio lighting control. The control board is located on the studio floor such that the operator can view the scene or the control room for cues, and has sufficient switches and dimmers for the accurate and noiseless control of each outlet.

The switchboard should contain a master switch to make possible blackouts and control of everything but work lights. The power is fed to fifteen individually fused and switchable outgoing 20 amp circuits—one for each ceiling outlet. If the finances of the station are such that a dimmer board can be added, then even greater

FIG. 23. Scenic layout of the "A-Prime" Studio.

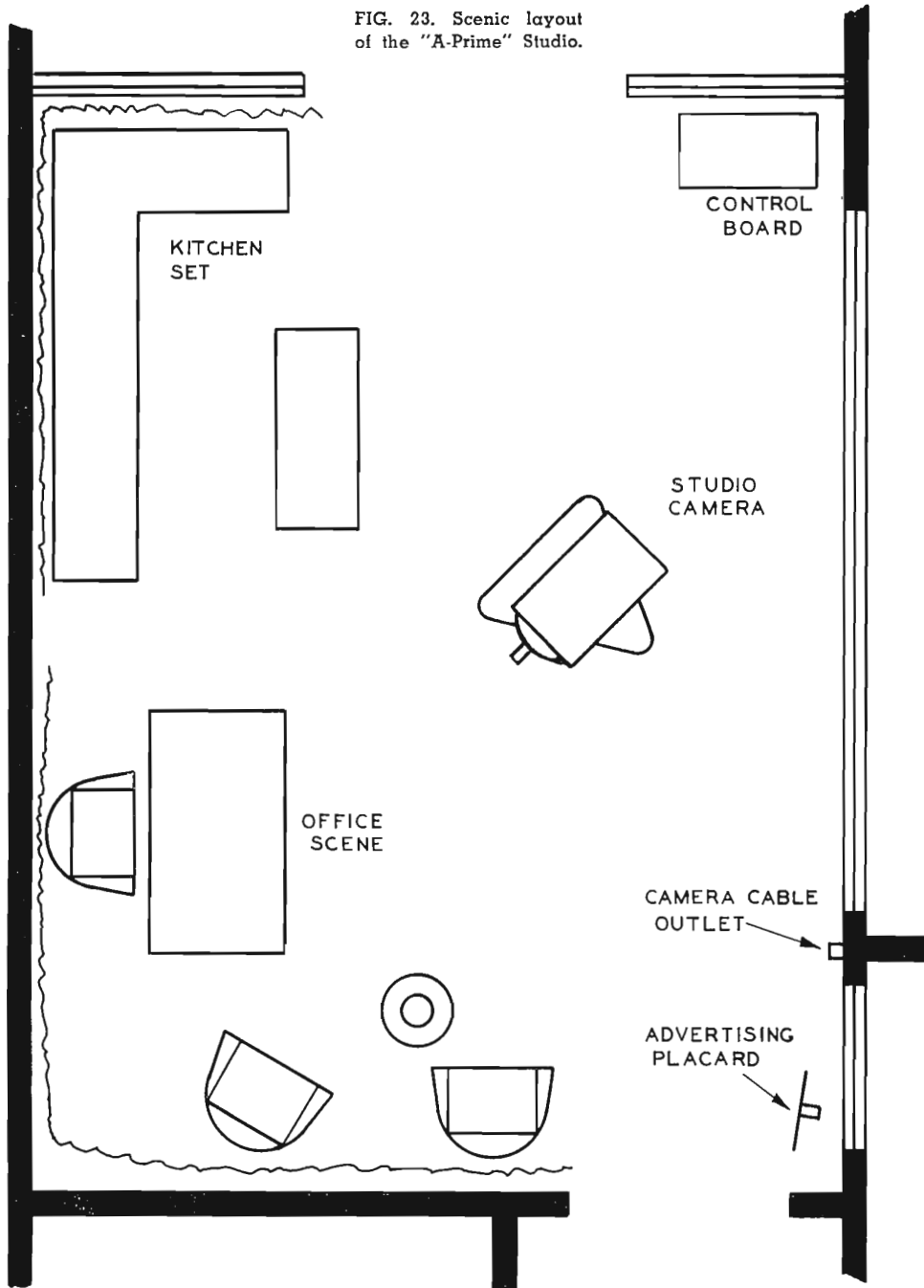



flexibility is obtained. Dimming makes possible special effects, transitions, and control of overall light level.

Practical considerations have limited the studio lighting system to a-c operation. The total a-c power service recommended for the switchboard input is 15 kw from a 3-phase, 4-wire, 60-cycle system. In addition to this, a special floor outlet box (as seen in Fig. 24) is recommended. This outlet in the middle of the scenic studio area has a 60-amp capacity female outlet and 3-pole switch for providing power to special high current equipment such as an electric range in the kitchen set.

The wiring system of this studio should have, in addition, outlets and connectors of suitable uniformity to make possible complete interchangeability of cable, outlets, or instrument. An equipment ground, carried throughout the system, insures the safety of all personnel.

### Lighting Sources

The scoop is a practical source to be considered for use in the Plan "A-Prime" studio. Three or four of these units on each scene can provide easily the desired wide angle base light of about 100 foot-candles. This light level will vary with the mood of the scene to be televised. When mounted on the pantograph hanger, they can be adjusted with the result that their beam strikes the scene at an angle no greater than 20 degrees and, with diffuser frames, give the proper breakup of the harsh light.

A number of fresnel spotlights and kliegs can provide the key and modeling light for the scenes. These units, together with suitable barn doors, can provide the proper, narrow-angled light to supply form for the scene. Their level should contribute 20 or 30% greater intensity to the average base lighting.

These spotlights can also provide the backlight of 50% greater intensity than the base light. The purpose of backlight is to separate the main actors from the background scenery.

The lighting system here described for the studio of Plan "A-Prime" is, we feel, entirely flexible and is a basic one. Only by utilizing their full capabilities together with the proper techniques can consistently good lighting be obtained. A suggested "A-Prime" basic lighting equipment list is shown here:

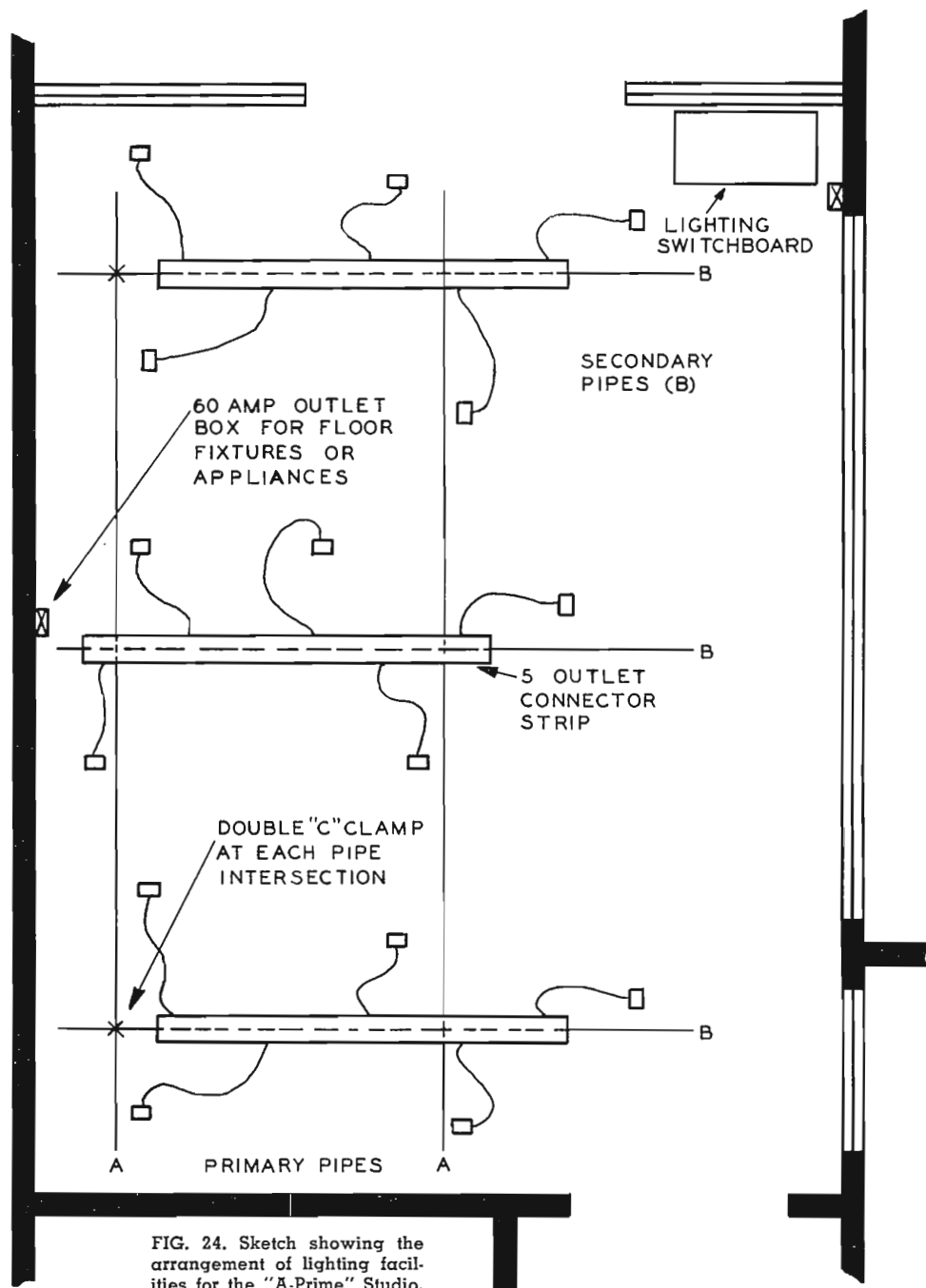

FIG. 24. Sketch showing the arrangement of lighting facilities for the "A-Prime" Studio.

### PLAN "A-PRIME" Typical Lighting Fixtures

Qty.	Fixtures
4	300-500 w. Baby Scoop
4	750/1000/1500/2000 w. 18-in. Scoop
4	250/500/750 w. Fresnel Spot
2	1000/1500/2000 w. Fresnel Spot
1	500 w. Klieg
1	250/500 w. Klieg

### Accessories

2	Diffuser for Baby Scoop
2	Diffusers for Scoops
2	Diffusers for Spots 44N6TVG
1	Roll Spun Glass Diffuser Cloth
2	2-Way Barn Doors for 44N8TVG

2	Roller Caster Stands
2	Extension Cables, 955G Connectors
2	Counterbalance Hangers

### Wiring and Control Devices

1	Portable Connector Strip Set, with 5 4-ft. pigtailed, and 20-ft. cable
1	Portable Connector Strip Set, with 5 4-ft. pigtailed and 25-ft. cable
1	Portable Connector Strip Set, with 5 4-ft. pigtailed and 35-ft. cable
1	Dimmer Switchboard, with 15 dimmable circuits, 6 4-kw dimmers, master 3-pole switch, and master dimmer arm
2	Location Feeder Box, 60 amp circuit and switch

# TV STATION PLAN "B"

## (Network, Film and Two-Camera Studio)

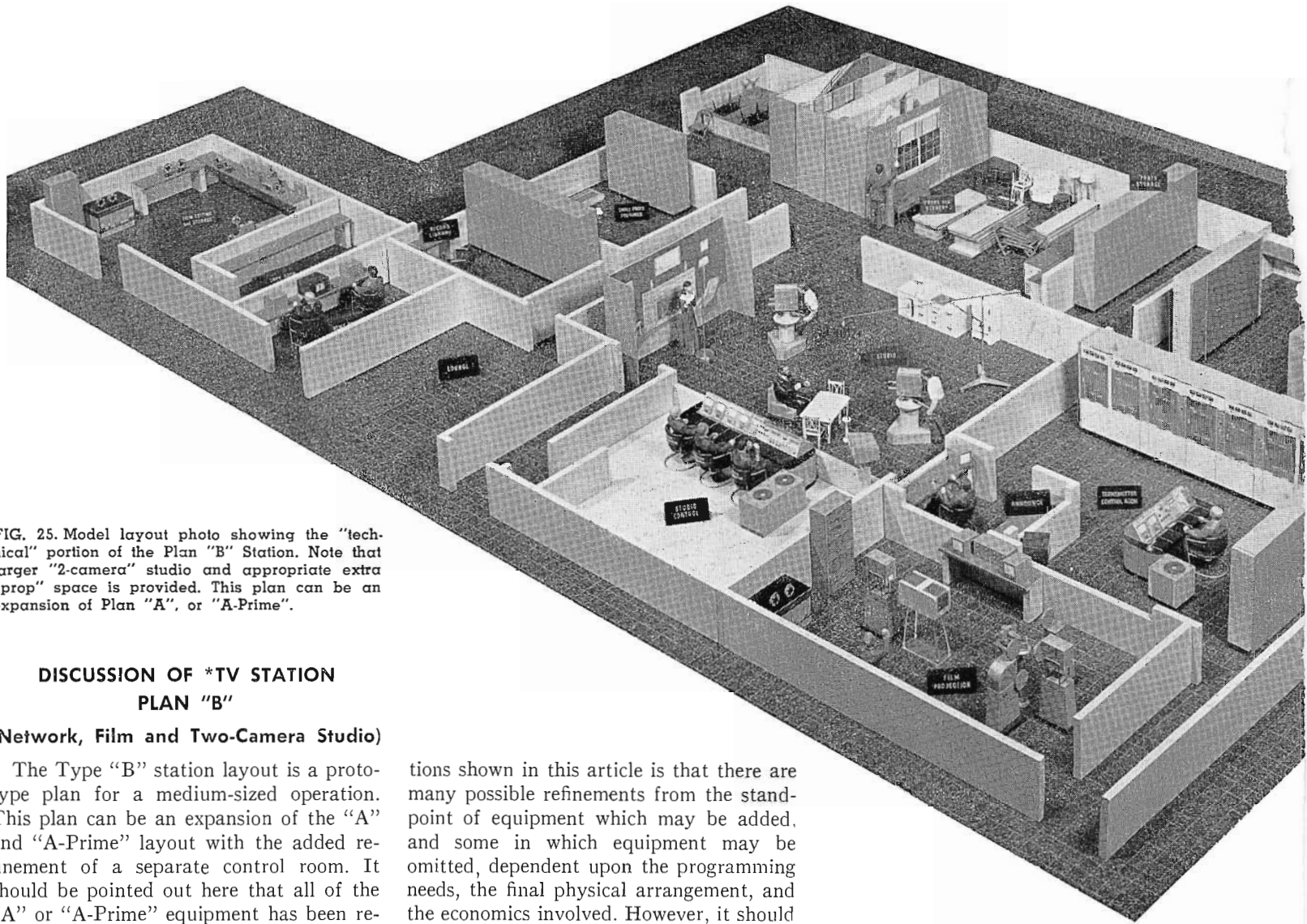

FIG. 25. Model layout photo showing the "technical" portion of the Plan "B" Station. Note that larger "2-camera" studio and appropriate extra "prop" space is provided. This plan can be an expansion of Plan "A", or "A-Prime".

### DISCUSSION OF \*TV STATION PLAN "B"

#### (Network, Film and Two-Camera Studio)

The Type "B" station layout is a prototype plan for a medium-sized operation. This plan can be an expansion of the "A" and "A-Prime" layout with the added refinement of a separate control room. It should be pointed out here that all of the "A" or "A-Prime" equipment has been retained to form the "B" or "Alternate B". Furthermore, it should be noted that field equipment may be used in place of the more permanent studio type, especially if economy is a more important or limiting factor than the permanence or maximum flexibility attained with the two sets of studio camera equipment shown. (See Figs. 25 and 26.)

One further observation which applies principally to the "B" and "C" type sta-

\* Note that for Plans "B" and "C", Audio schematic diagrams are not included for reasons of simplicity. Complete descriptions of applicable TV audio systems are available in previous issues of BROADCAST NEWS. (See Jan-Feb. 1951 BROADCAST NEWS, "A Flexible TV Audio System," and July-Aug. 1951 BROADCAST NEWS, "A New AM-FM-TV Console.")

tions shown in this article is that there are many possible refinements from the standpoint of equipment which may be added, and some in which equipment may be omitted, dependent upon the programming needs, the final physical arrangement, and the economics involved. However, it should be remembered that each of the items of equipment illustrated in the functional diagrams serves a definite and useful purpose. (See Fig. 27.)

The functional diagram illustrates how Plan "B" station provides the facilities necessary for broadcasting the following types of programs:

- (1) Local studio programs.
- (2) Standard 16mm film entertainment and commercial film.
- (3) Slides, opaques and news releases.
- (4) Network programs.
- (5) Test pattern from the monoscope camera.

- (6) Remote programs—programs picked up at points remote to the studio with portable field equipment (programs are sent back to the station by coaxial cable or microwave relay).

The facilities for the type "B" layout include: one average-sized, live talent studio with associated control room (see Fig. 26), a "two-film-camera" projection room, an announce studio and master control or transmitter control room. In some larger stations the film projection room may have its own associated control room, but in this plan the film camera controls are located in the transmitter control room which serves very well as a master control

center. Video equipment racks (see Fig. 29) are located in the centralized control room and in the engineering workshop.

### Studio Equipment

Equipment for the "B" plan studio consists of two complete Type TK-11A Image Orthicon Cameras plus the necessary lighting equipment and scenery for producing live talent shows. The cameras are complete with electronic view finders studio type pedestals, video cue monitor and cueing speaker. The necessary microphones

with program stand mountings and boom mountings are also included. In both "A-Prime" and "B", it is desirable to locate a TM-2B Utility Monitor in the studio. Plan "B" studio can be utilized as a "three-scene" studio with the additional feature (also provided in Plan "A-Prime") of pointing a camera through the announce booth window for "disk-jockey", news or announce shows, where this type of operation can be satisfactorily accomplished.

### Studio Control Room Equipment

Refer to the diagram of Fig. 28 which shows the arrangement of the control equipment. Reading from left to right are the two studio camera controls which contain the TM-6A Master Monitors with 10-inch picture monitor tubes and 5-inch waveform monitor tubes. Next is the TS-10A switcher with the same type picture tube and waveform monitor as provided in the camera control sections. Next in line is the preview monitor operating from a new type (MI-26227) monitoring switch installed in a standard console housing. The associated monitor is the same as that mentioned previously for camera controls and switcher. Next is the remote control section, BCS-13A VI and Ringdown Console, the audio console, and turn-

tables. The remote control section houses the controls for the stabilizing amplifiers, monoscope camera and projector control. Shown in the block diagram (above the operating console) are two utility monitors. A third utility monitor is shown "dotted-in" as an alternate.

Before describing the functions of the control room equipment, it should be noted here, as has been mentioned in the introduction, that the location of video consoles is a matter of personal choice dictated by the mode of operation preferred. For example, the program director may be seated on a raised platform directly behind the operating console where he can easily view all of the monitors and see into the studio as well. It is also possible to remove the TS-10A Switching Unit from the line-up and place it on the program director's platform where the director may control the switching functions and also have "fingertip" communication to cameras.

Remote starting of projectors may be accomplished by providing a remote control panel at director's position. Control may be transferred to this point by the projectionist as soon as he has the projector loaded with film.

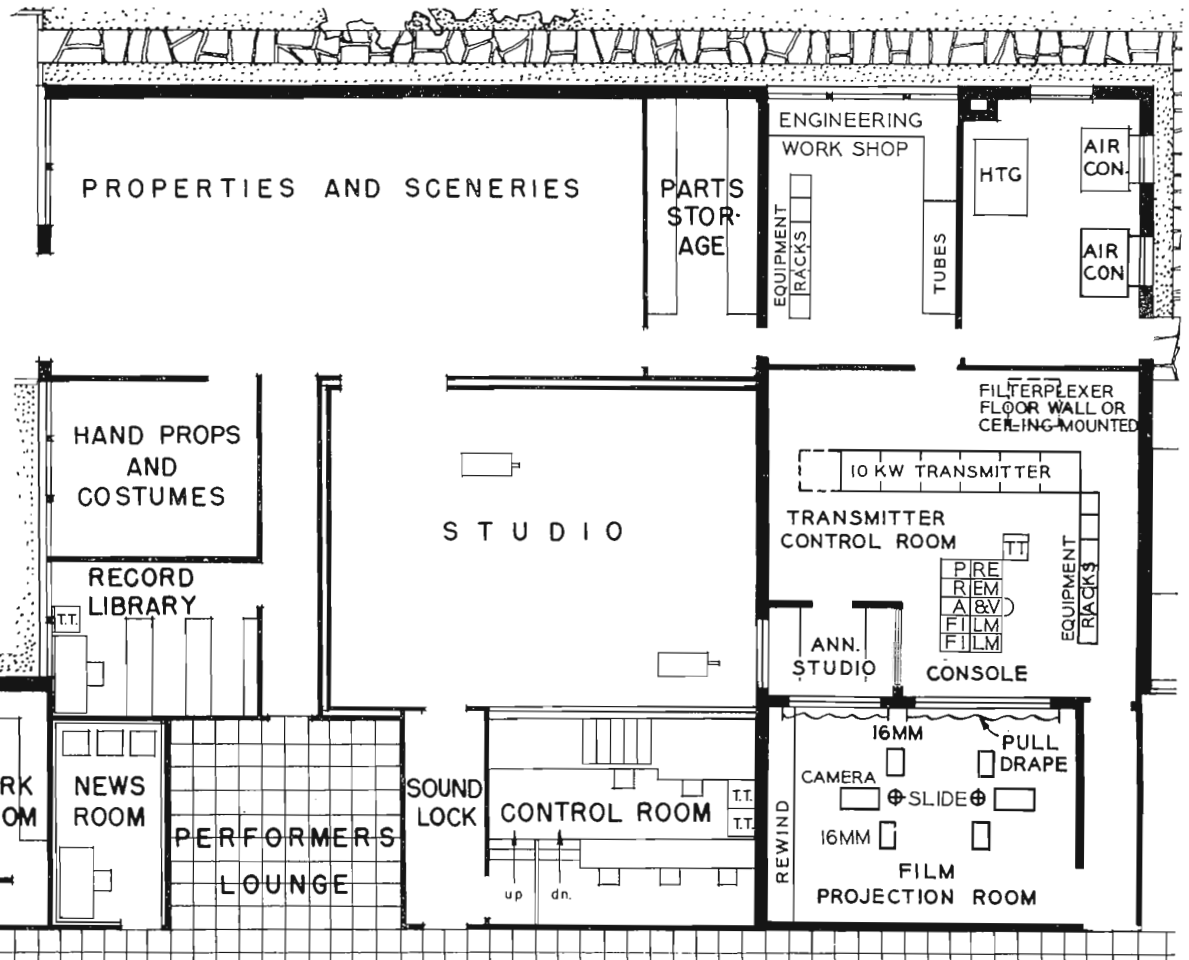
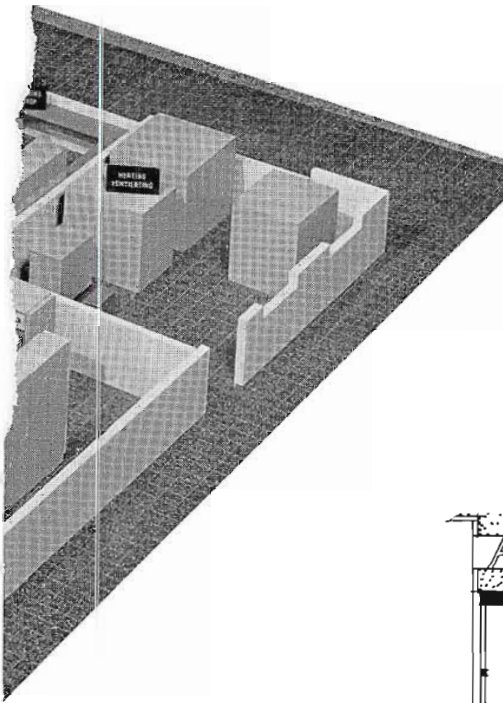
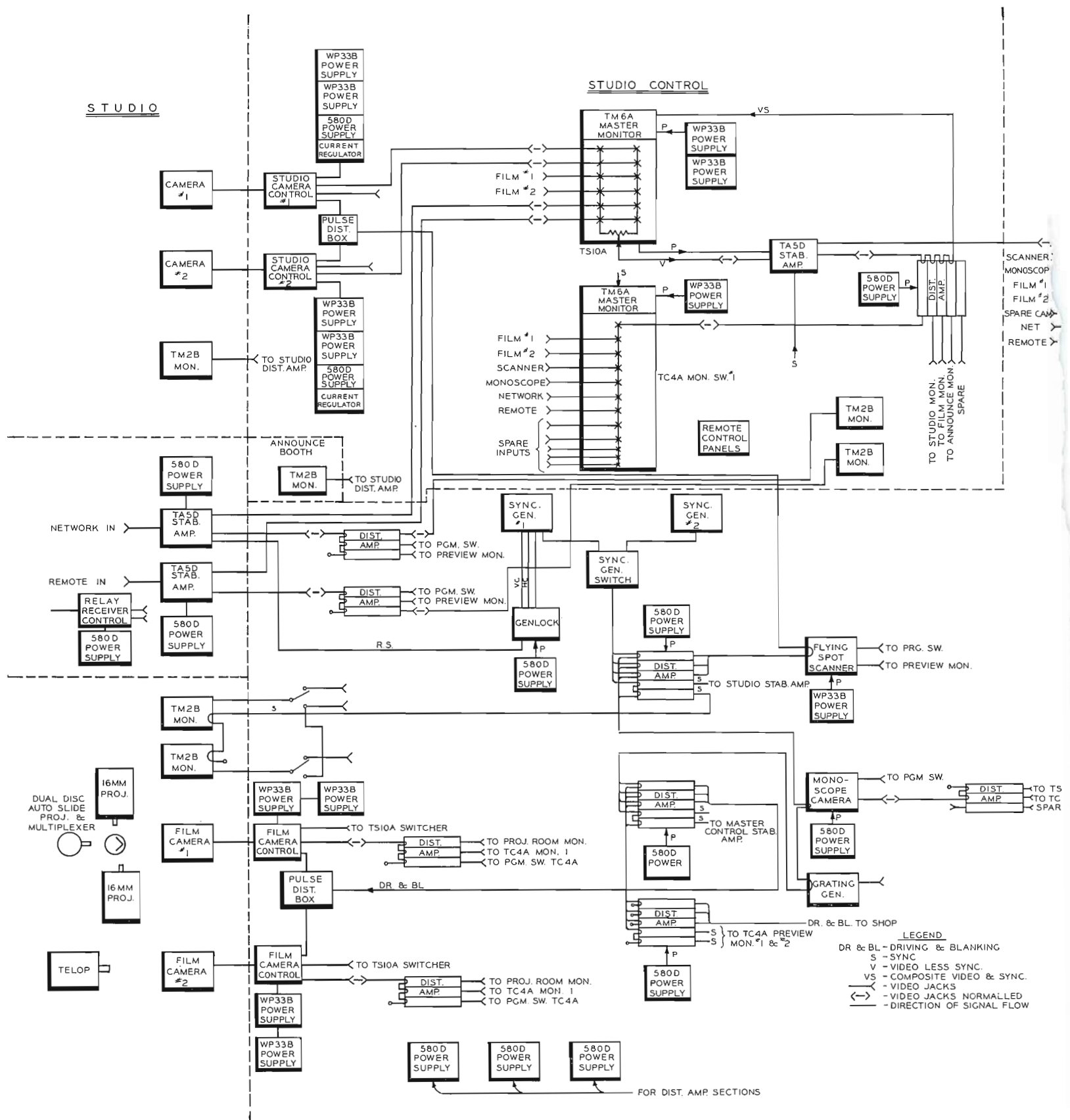

FIG. 26. Floor plan showing the technical facilities for the Plan "B" Station.

FIG. 27. Video system diagram showing the interconnection and arrangement of the Plan "B" equipment. Note that audio components required for TC-4A operation are not shown, but are like those shown in "A-Prime", Fig. 20.



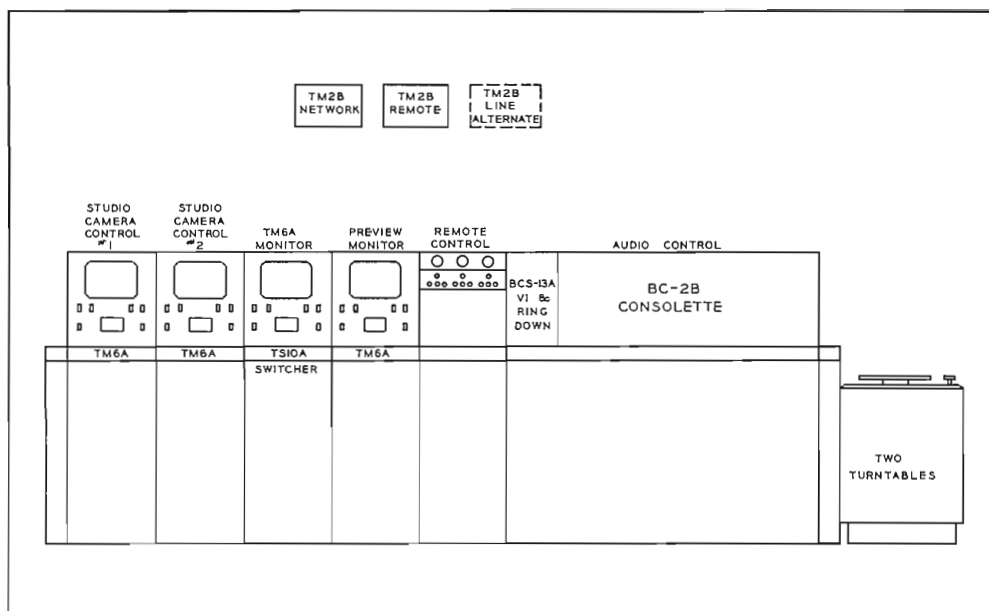
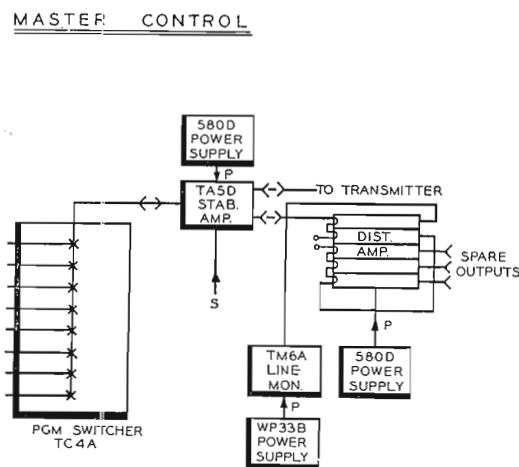
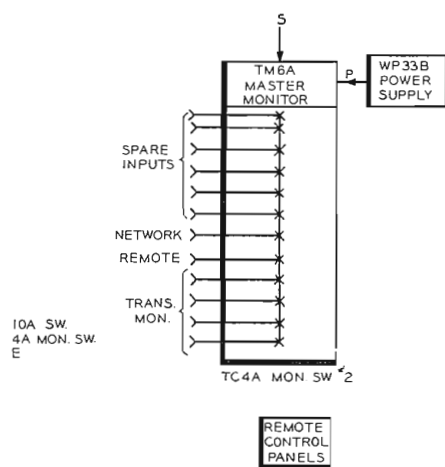

FIG. 28. The basic Plan "B" Studio has its own control room where video and audio control monitoring and TS-10A mechanical switching facilities are arranged as shown above.



In either system, the video operator has control of the picture signals emanating from each studio camera. He maintains the proper shading and contrast. He may, in certain instances, perform the switching functions at the request of the program director. However, it is possible that the director may perform his own selection of signals and at the same time preview the signals on the adjacent monitors. The preview monitor switching in that case may have to be performed by the video operator, and the preview monitor should then be located to the right of the switching and fading unit for convenience. It is possible to preview network and remote signals on the TS-10A Switching and Fading Unit, but it is not always possible if local signals are fed into those positions. Furthermore, it is more desirable to keep one monitor in the outgoing signal at all times while previewing all signals on a separate monitor. In addition, it is also desirable to have a good waveform monitor for line and preview functions in order to adjust the video signal levels properly and correlate all readings to one unit as a standard. Therefore, the preview monitor is added, and all signals may be previewed on this monitor before they are switched on the air.

The console section, next in line, contains the remote control panels, which may regulate the functions of the stabilizing amplifiers, the monoscope camera, film projectors and slide projectors. Incidentally, this is an alternate position for these controls because in many instances it may be desirable to place them in master control. As a matter of fact, the projector con-

trols may be located at both places; in which case, it is necessary to provide a switch that will transfer control to one location or the other.

Next in the line is the audio consolette and the BCS-13A VI/Ringdown Console. The RCA BCS-13A Auxiliary Console is available on a "semi-custom" basis, and is included in both "B" and "C" Plans. A rack of associated equipment located in the studio control room is required for use with this unit. It should also be noted that *this rack is not included among those shown in Figs. 29, 49 and 50.*

In most cases, it is well that the audio operator be in a position to see the studio clearly in order that he can properly ride gain, when the actors are moving about the studio.

A sufficient number of inputs, both video and audio, should be provided for studio projectors, turntables, announce, remote, and network signals. Where more than one studio is used it is well to provide additional inputs for the second studio.

The BCM-1A Auxiliary Mixer Console, which is utilized in Plan "C", should be considered as a possibility for Plan "B" where the extensive use of microphones is planned. The BCM-1A permits the use of any four of twelve additional microphone inputs and can be mounted alongside the consolette.

#### Studio or "Video-Relay" Switching

Where requirements dictate a still more flexible switching system or where more than six video inputs are used, it is recom-

mended that a relay switching system be considered. (See Figs. 31-32.) The studio relay-switching system used here is designated as the Type TS-20 Switching Equipment. Basically, it consists of the TC-5A program console with its monitors, banks of momentary-contact pushbuttons and tally lights, and fader controls mounted on the console desk, plus associated rack-mounted equipment such as relay panels, fader amplifiers and stabilizing amplifiers. As can be seen in the drawing of Fig. 32, signals from all cameras including monoscope test cameras, network and relay signals, when patched into the relay system, can be switched to master control. These local signals may also be lap-dissolved and faded.

WP33B POWER SUPPLY CAMERA	WP33B POWER SUPPLY CAMERA	WP33B POWER SUPPLY TS10A SWITCHER	WP33B POWER SUPPLY FLYING SPOT SCAN.	580D POWER SUPPLY DIST. AMP.	580D POWER SUPPLY MONOSCOPE
WP33B POWER SUPPLY CAMERA	WP33B POWER SUPPLY CAMERA	WP33B POWER SUPPLY TS10A SWITCHER	580D POWER SUPPLY RELAY RCVR. CONT.	580D POWER SUPPLY DIST. AMP.	580D POWER SUPPLY GENLOCK
580D POWER SUPPLY CAMERA	580D POWER SUPPLY CAMERA	WP33B POWER SUPPLY PREV. MON.	580D POWER SUPPLY NET STAB. AMP.	580D POWER SUPPLY DIST. AMP.	BLANK
CURRENT REGULATOR CAMERA	CURRENT REGULATOR CAMERA	WP33B POWER SUPPLY PREV. MON.	580D POWER SUPPLY REMOTE STAB. AMP.	580D POWER SUPPLY DIST. AMP.	BLANK
WP33B POWER SUPPLY FILM	WP33B POWER SUPPLY FILM	WP33B POWER SUPPLY PGM. LINE MON.	580D POWER SUPPLY TC4A STAB. AMP.	580D POWER SUPPLY DIST. AMP.	BLANK
WP33B POWER SUPPLY FILM	WP33B POWER SUPPLY FILM	WP33B POWER SUPPLY PGM. LINE MON.	580D POWER SUPPLY DIST. AMP.	580D POWER SUPPLY DIST. AMP.	BLANK
BLANK	BLANK	BLANK	BLANK	580D POWER SUPPLY DIST. AMP.	BLANK

FIG. 29. Rack layouts for the Plan "B" Station. Racks are divided between the centralized transmitter room and the engineering workshop.

SYNC. GENERATOR NO.1 TYPE TG-1A	SYNC. GENERATOR NO.2 TYPE TG-1A	DISTRIB. AMPLIFIER	RELAY RECEIVER CONTROL	DISTRIB. AMPLIFIER	DISTRIB. AMPLIFIER	GR-1183 FREQ. & MOD. MONITOR EQUIP VISUAL & AURAL IN TOP 3 PANELS	BLANK	
		DISTRIB. AMPLIFIER	MONOSCOPE CAMERA	DISTRIB. AMPLIFIER	BLANK		BLANK	
		DISTRIB. AMPLIFIER	STAB. AMPLIFIER TS10	BLANK	BLANK		BX-1E PRE-AMP P.S.	BA-13A LINE AMP.
		GRATING GENERATOR	STAB. AMPLIFIER REMOTE	JACK PANEL	BLANK		BA-6A LIMITING AMP.	
		GENLOCK	STAB. AMPLIFIER NET	JACK PANEL	BLANK		AUDIO JACK PANEL	
		BLANK	STAB. AMPLIFIER MASTER CONTROL	JACK PANEL	BLANK		B.P.MI-4590-A	
		CKT BKT.	BLANK	JACK PANEL	BLANK		BA-11A PRE- AMPLIFIERS	
		CKT. BKT.		BLANK	BLANK		16MM. SOUND EQ.	
	SYNC GEN SWITCH				BA-14A AUDIO MON. AMP.	BX-4A RELAY P.S.	BLANK PANEL MI-4594-B	

The TC-5A Program Director's Console is another outstanding feature of the video relay control system. This console is designed expressly for use by program and technical directors in supervising studio programs. The console is only 37 inches high (which allows full view over the top and into the studio). It can accommodate as many as five 10-inch monitors, which are recessed below the desk top to prevent direct light from striking the screens. These five monitors can provide the directors with preview pictures of all cameras, if desired, plus pictures from a network signal and the program line.

The illustrations show the use of five monitors in the console (see Fig. 31). The first three monitors are permanently associated with the two cameras and a possible third; the fourth monitor displays the upcoming signal which is selected by one row of pushbuttons and the fifth is on the program line which is also associated with one

row of pushbuttons, usually called program line.

The director's console is unique in that the program and technical directors have large bright pictures of the program directly before them and need not depend on their ability to see the monitors in the video operator's console, which may be located several feet away or in a different room. In this setup, the technical director would ordinarily do the necessary switching at the request of the program director. Both directors can use the intercom and talkback system built into the console for communicating with production and technical personnel at the cameras and in the control room, projection room, dressing rooms, etc. The program director's console contains the pushbutton switching panel which operates rack mounted relays (located remotely) for camera switching. It also contains 10-inch monitors which pro-

vide the director with the necessary picture information which he may select.

With the video relay switching systems, all video inputs may be handled at one central location, thereby simplifying the video cable distribution system. Several other advantages, such as simultaneously switching audio and video, "sync" interlock, extended control of tally lights, and previewing of special effects may be easily accomplished.

#### Plan "B" Master Control

Master Control is that portion of a switching system which selects the desired composite signal for final transmission, be it for network, transmitter or both.

It is imperative, therefore, that some means be provided to monitor both audio and video incoming and outgoing signals. In the cases of both audio and video a means of adjusting voltage levels must be provided. A "VU" meter usually provides

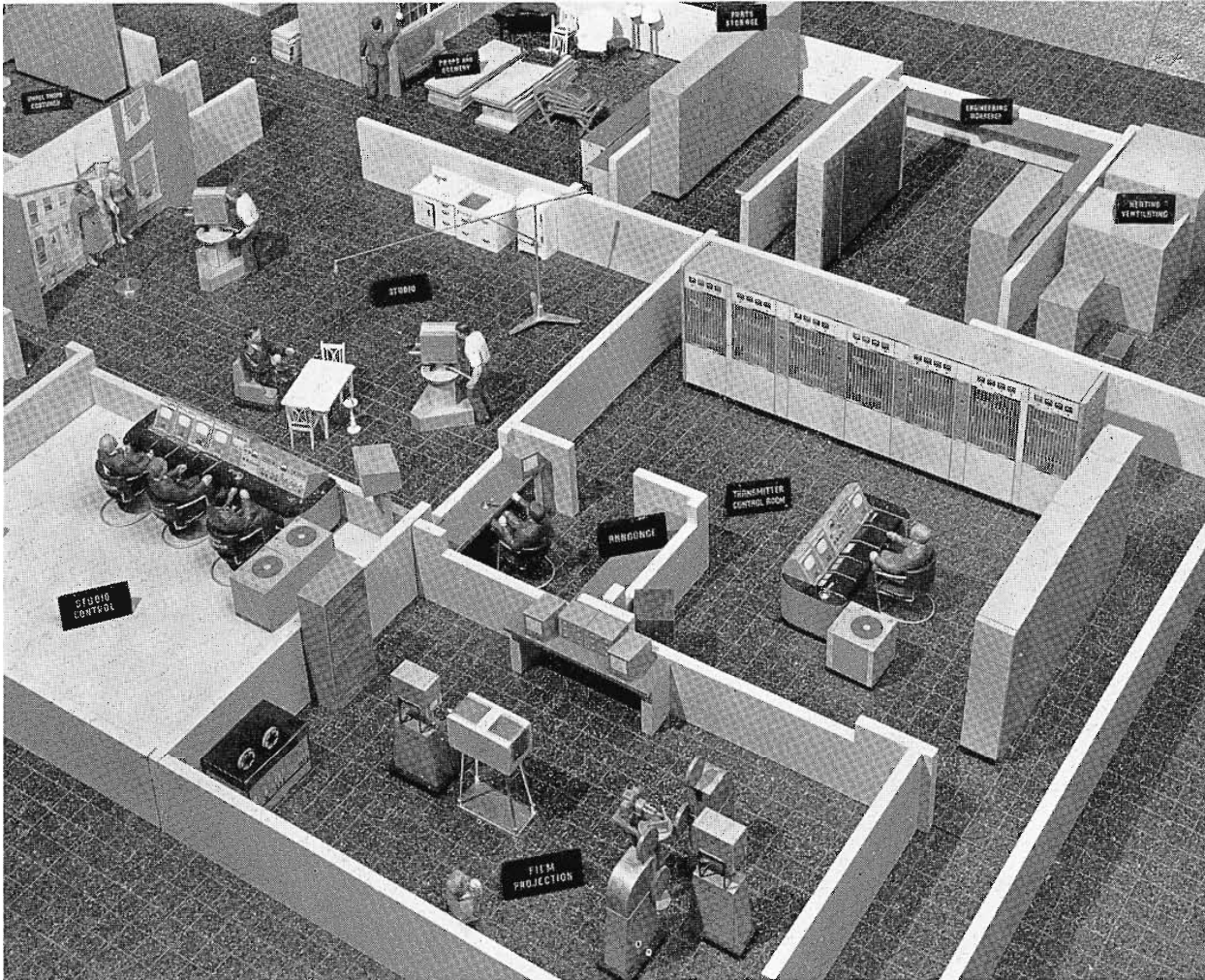
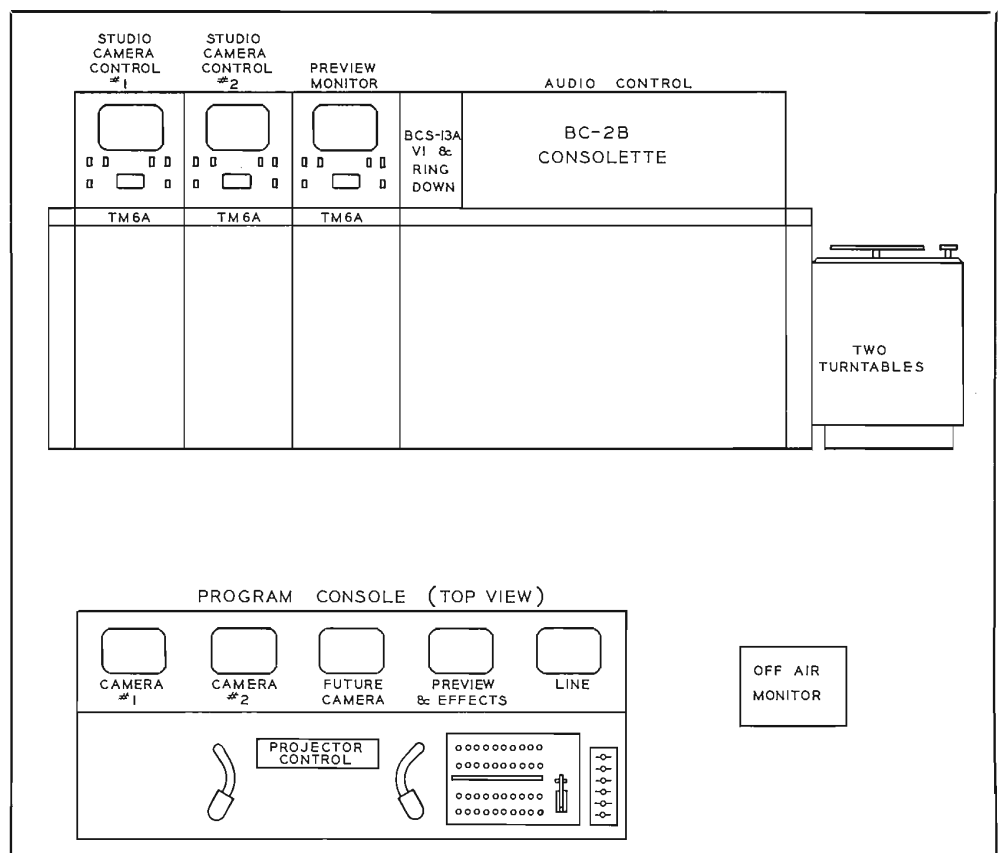

FIG. 30. Closeup of a portion of the "B" Plan Station showing the heart of the technical activity. In the control room (from left to right) are: the video operator at the camera monitors, the program director at the TS-10A Switcher and Remote Control Section, and the audio operator at the BC-2B Consolette. The film room shows the use of the TK-20D Film Camera and a Telop Projector as the second film chain to provide for opaques. This photo also illustrates the use of the TTU-10A (RCA 10-KW, UHF Transmitter) with the water cooler and transformer located in the heating and ventilating room.

this service for the audio signal while a cathode ray oscilloscope acts in a similar fashion for the video signal. Generally these indicators are provided as "built in" adjuncts of various items of equipment. For instance, the VU meter is a part of the audio consolette and the TC4A switching system, while the cathode ray oscilloscope or waveform monitor is an integral part of the RCA TM6A Master Monitor.

In considering any master switching system, it should be borne in mind that some means must be provided for monitoring audio and video inputs and outputs, and also to measure and establish proper signal levels. Obviously, an ideal system would be one which provides monitors for all signals at all times, but such a system could be quite cumbersome, complex and expensive. The next simpler and more practical system is one in which a monitor is always on the outgoing line, while another is switchable to any of the incoming signals.

FIG. 31. An "alternate" arrangement of control room equipment in Plan "B" where the TC-5A Program Director's Console is employed to provide further flexibility with video-relay switching.



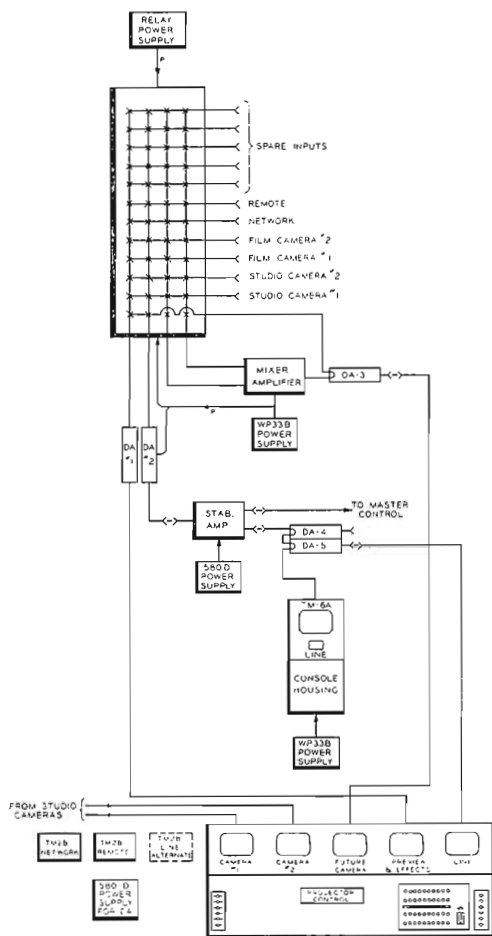

Some systems planners feel that further economy is necessary and, therefore, provide an inexpensive monitor on the outgoing lines and make the switchable one a TM-6A master monitor type, which has a high quality video system and a waveform monitor.

Where a separate master control room is used, it is customary to bring incoming network and remote lines into this central (clearing house) point.

All necessary adjustments and the distribution of these signals is accomplished in Master Control. They are then fed to their respective points of use by means of a system of jacks. In these cases, it is also a practice to provide inexpensive monitors which are always on the line merely to indicate that there is a signal present. The switchable monitor, as mentioned before,

FIG. 32. Simplified diagram showing the "alternate B" control room with the TC-5A Program Console providing five monitors. Note that the "future camera" monitor is connected to the "effects" bus permanently to permit continuous monitoring of the fader circuit. In addition, effects and other signals may be "punched-up" and observed on the "Preview" Monitor.

is used to make the necessary technical checks and adjustments. In each of these cases the same conditions are assumed for audio and video signals. Furthermore, as illustrated previously, duplicate monitoring facilities may be provided in the studio control room.

A simple arrangement for the type "B" layout is to use the RCA TC4A switching system as shown in the drawing of Figs. 27 and 28. This in effect, is the same basic system as that employed for stations "A" and "A-Prime" and treats the studio output as a remote signal. In this instance, however, the TC4A in Master Control serves a dual function. In addition to being a master switching console, it provides programming service when the studio equipment is being used for rehearsal, or is completely shut down, thereby keeping the cost of operation to a minimum. The monitoring section of the TC4A may be used to preview all video and audio signals, and also monitor the several transmitter signal check points.

There are also other means of switching signals at Master Control, as for example, the simplest form using bridged T networks, designated as RCA's TS-1A switch-

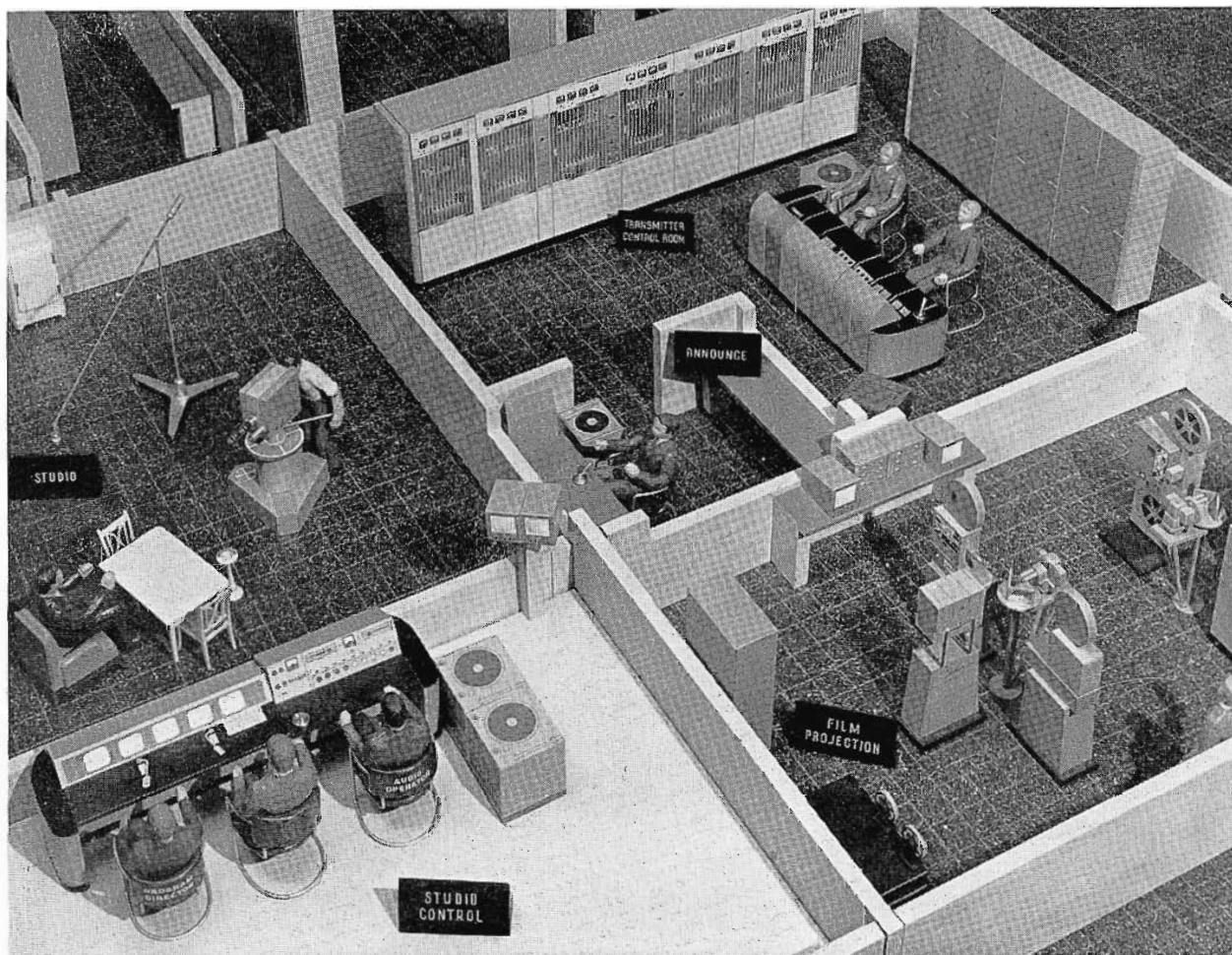

FIG. 33. Model layout showing the alternate "B" arrangement of the studio control room where the TC-5A Program Director's Console is used. Note transmitter control room where provision is made for studio camera controls, film camera controls, audio/video switching, remote control and "Preview". This permits complete control and switching to be performed at this point, when desired.



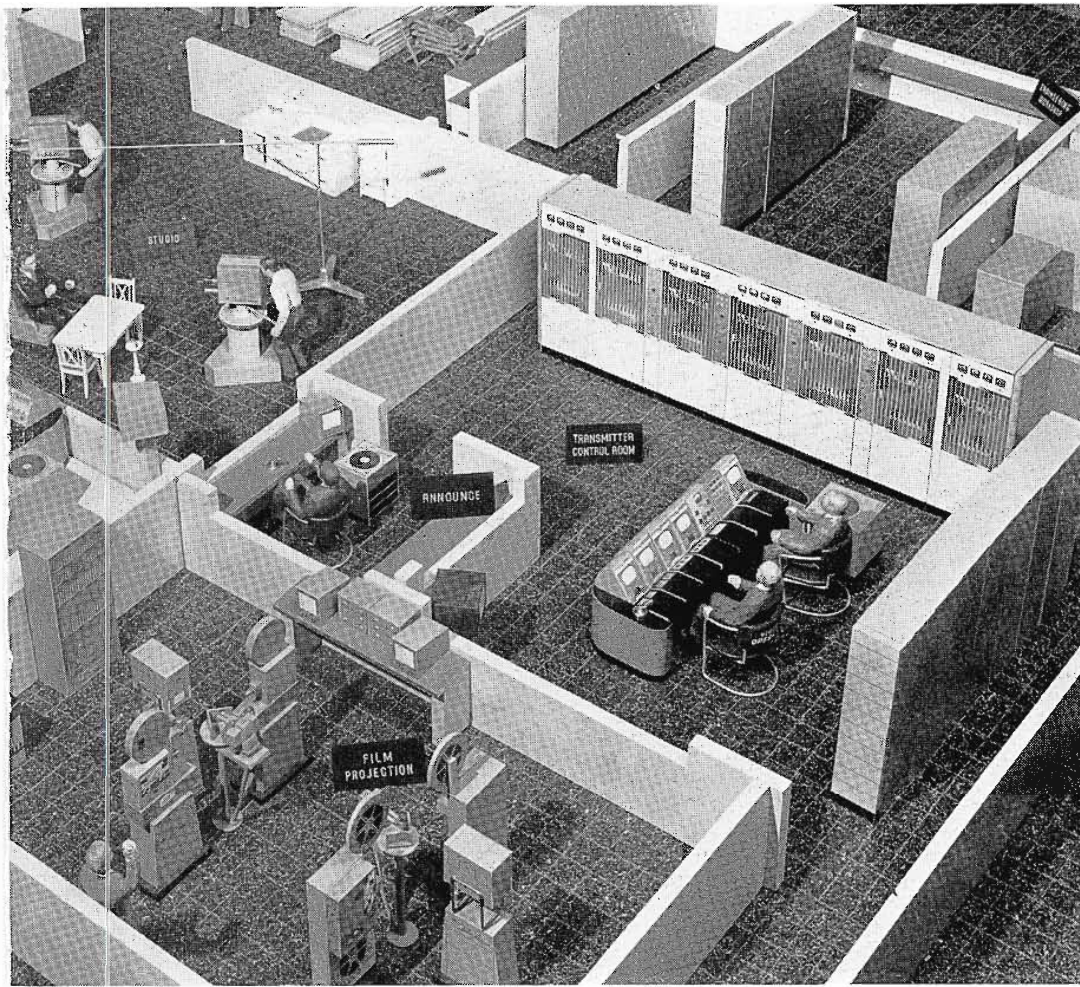

FIG. 34. Another view of the Plan "B" alternate arrangement which shows a front view of the transmitter "centralized" console where camera controls are located. Also shown more clearly is the film projection room. Note that, in this case, two TP-35, 35mm Film Projectors have been added for the second film chain. Power supply equipment racks are located in the engineering workshop, and video equipment racks in the transmitter control room.

room shall be all inclusive of the necessary film facilities (see Figs. 39 and 40). Almost any station of this size should have at least two film camera chains with a combination of two 16mm projectors and a slide projector for one film camera, and a choice of additional 16mm projectors, 35mm projectors, slide projector or a Telop for the second film chain. Naturally these choices will be dictated by the type and extent of programming the station plans to use. However, present operating techniques and costs invariably lead to an installation of at least two 16mm projectors and a slide projector for one film chain, with local condition and personal choice providing the selection for the second camera. In some instances a third film camera has been installed and if this is planned, the appropriate extra space should be provided.

One important source for the second film camera would be the use of a Telop projector which makes use of 3 x 4 transparencies, opaques and news tape, and has a stage for handling small objects like watches and other jewelry pieces. To be able to fade and lap dissolve with this pro-

ing panel (see diagram of Fig. 35). This consists of a mechanically interlocked system with six inputs and three outputs, two for line and one for monitor. It is normally a rack mounted panel for video only, and requires the distribution amplifier sections in close proximity in order to maintain good frequency response. By means of an extra contact on each switch position, relays may be actuated to switch audio and video simultaneously. The TS-1A Switching Panel may also be adapted for mounting in the RCA MI-14905 table turret combination which can be used adjacent to, or "in-line" with other operating consoles (see Fig. 36). Since the lower portion of this table is fitted with rack mounting angles, the distribution amplifier can be conveniently mounted within, and leads from the TS-1A can be kept short.

A still more flexible method of performing master switching is to use the video-relay system, which is described in detail under Plan "C". Here, as in the Studio Camera Relay Switching, the same advantages of shorter video cables, greater flexibility, and more complete control are realized (see Figs. 37 and 38).

### Film Projection Equipment, Editing, Processing

As in Plans "A" and "A-Prime", the film facilities may again be regarded as a vital income producer of the station. It is, therefore, important that the projection

FIG. 35. Simplified diagram showing the possible use of the RCA TS-1A Master Control Switching Panel which provides six inputs and three outputs.

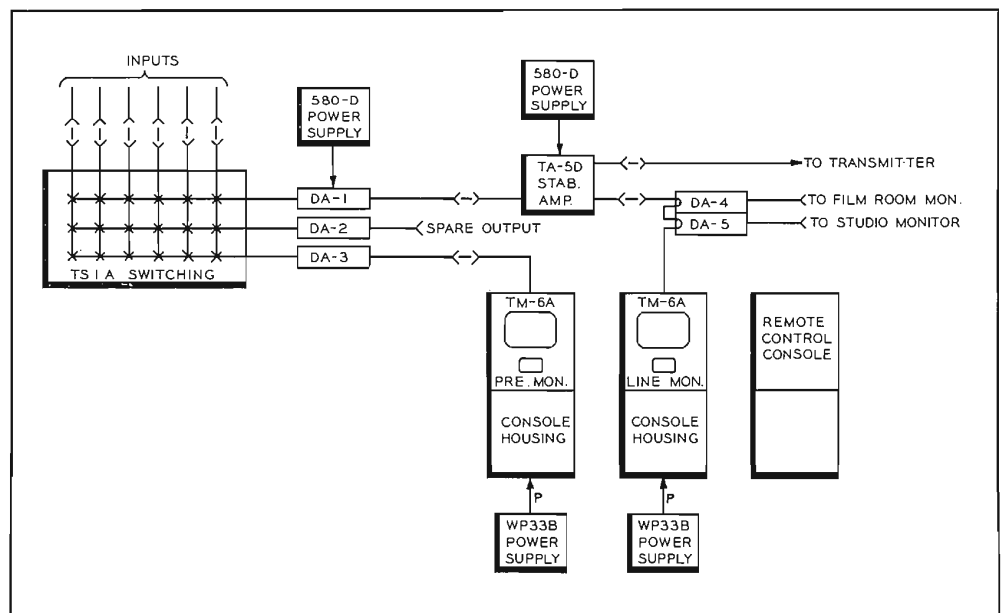

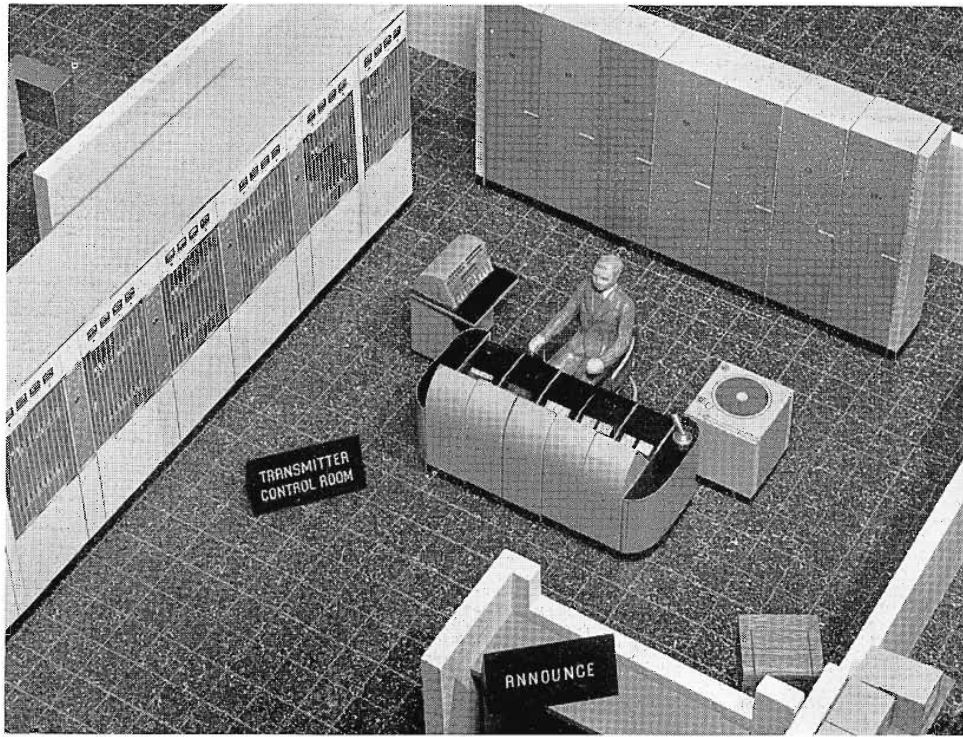

ways a picture on the screen even during slide changing intervals. This is accomplished by using a dual set of lenses, projector lamps and slide containers. When one slide is projected, the next slide on the second disc moves into position. All of this operation may be performed by one pushbutton operation. In other words the projector is semi-automatic in operation. Another item of film projection room equipment worthy of consideration for use in any of the four plans is the Gray Model 556 TV camera turret and pedestal. This permits the rotation of the camera so that "multiplexer-reflected" images can be picked up from several film projectors and Telop slide projector (as shown in Fig. 41). Four detents or stops on the rotatable turret enable the film camera to be swung to the desired picture image source.

The film projection room should be large enough to provide a work bench, with rewind facilities, film splicing equipment and film storage. Sufficient space should also be

jector, adds greater flexibility to the operation. The Gray Telop II projector will perform this function very well, requiring a minimum of space and power.

In some instances, there may be a use for 35mm projectors, and two would usually be required, because feature length film is furnished in several reels and would, therefore, necessitate switching between two machines.

Many operations, by virtue of their programming requirements, may be of such a nature that they require a type of 16mm projector which has special features beyond the normal requirements of those demanded of the TP-16D. In those cases the RCA TP-6A is recommended, since it has many features that deserve careful consideration in the preliminary planning stages. It offers: automatic projection lamp change in less than  $\frac{3}{4}$  second, dual focus control, quick exciter lamp change, 4000-foot reel capacity, providing about 1 hour and 50 minutes of program time, and "2-3 claw" intermittent with sapphire tooth inserts for long life.

Fig. 40 shows a recent addition to the RCA projector line, known as the Dual-Disc Automatic Slide Projector which is utilized to advantage in all four plans. It can be mounted on the conventional Multiplexer stand, thereby projecting an image directly on the mosaic of the iconoscope tube. This projector may also be operated by a remote control pushbutton. It has a total capacity of twelve 2 x 2-inch slides and the advantage that there is al-

FIG. 36. Model layout illustrating how the TS-1A Master Switching Panel can be housed in the RCA, MI-14905 table turret combination and conveniently located near the operating consoles.

FIG. 37. Model photo showing a closeup of the video-relay switching panel located in a console section to provide master switching in the transmitter control room.

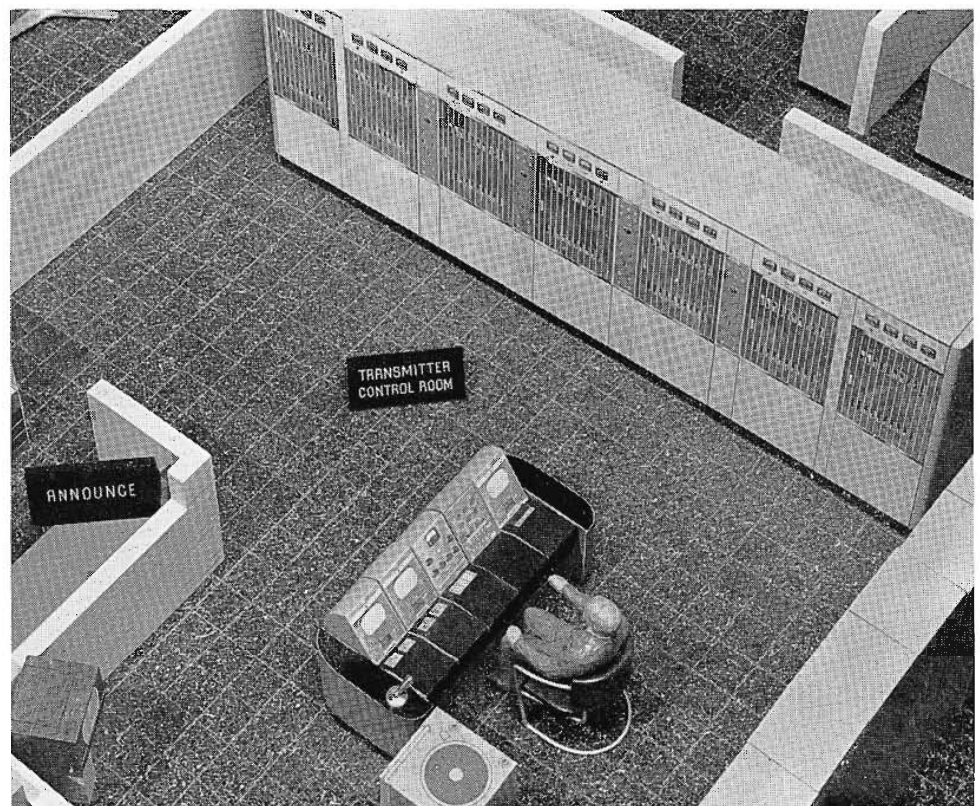

# TV STATION PLAN "C", (Network, Film, Two Live Studios and Remote Facilities)

## DISCUSSION OF PLAN "C" (Network, Film, Two Live Studios and Remotes)

The first considerations in the planning and building of a TV station of the Plan "C" size are: (1) the use of two or more live talent studios, (2) expansion of the customary film facilities, and (3) the use of a separate master control setup. This type of station also includes facilities for originating and broadcasting network shows.

Specifically, such a station is usually provided with the following, which are included in Plan "C". (See system block diagram of Fig. 51 and plates of 44-48.)

1. Film projection rooms which may have a separate control room, if desired.
2. Two or more studios with individual control rooms so that rehearsals may be carried out while other studio programs are "on-the-air".
3. Facilities for picking up remote events.

4. Master Control room where desired program material may be selected from any of the previously mentioned sources for network and broadcast purposes. Master Control may or may not be a combined transmitter control room depending on the particular conditions involved.

### General Plan "C" Considerations

The same general considerations described for the smaller stations also apply to Plan "C" and there are several additional points that deserve attention. First, it should be understood that the Plan "C" station is not the ultimate as far as "all-inclusive" programming and studio facilities are concerned. However, it does

illustrate one possible arrangement of studios and the companion equipment needed for the larger or "master-type" station.

In some instances, the physical arrangement of various control units may be such that differences in electrical time between various pulses in the system become greater than can be endured for proper operation. In that case, it becomes necessary to compensate for these differences. If the differences are small, it may be practical to use

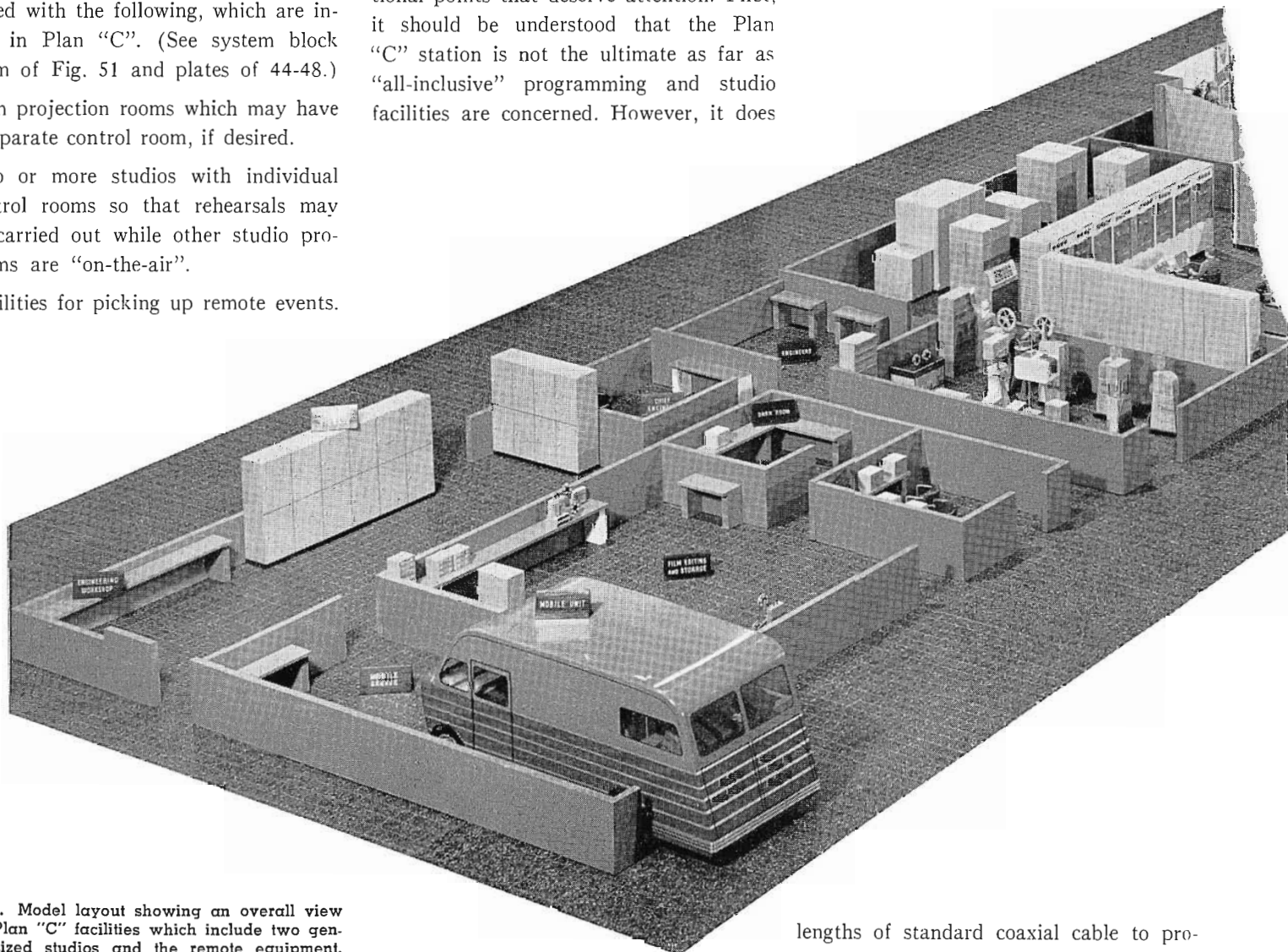

FIG. 44. Model layout showing an overall view of the Plan "C" facilities which include two generous sized studios and the remote equipment.

lengths of standard coaxial cable to provide the needed compensation. Where differences are appreciable, it may be more practical to use a delay line designed specifically for the purpose.

slide projectors or motion picture projectors featuring high brightness lamps.

The inclusion of barn doors, diffusers, iris, shutters, and other accessories permits these fixtures to be utilized to their fullest extent. Together then, with a versatile selection of efficient fixtures capable of rotating 360 degrees and tilting 85 degrees from the horizontal, it is possible to artistically enhance the TV scene.

From an economic sense, only a small number of fixtures will be used at any one time; and could, therefore, be moved from one scene to the next as required by the production. This is not feasible in TV, since time and manpower are at a premium; therefore, it is recommended that sufficient fixtures be provided initially to light the entire studio.

Of further importance in regard to fixtures is the possible use of fluorescents, which are practical in studios where heat dissipation or air-conditioning is a problem. When used, they must be reinforced with scoops up to 50% of the total light output. However, scoops alone are by far the cheaper to install and maintain, and are, therefore, recommended for the more maneuverable kind of base light for the Plan "B" studio.

The cost and type of lamp bulbs to be used with these fixtures is another economic consideration in the TV studio. By choosing a good quality, long-life lamp, and by standardizing on only a few types of lamps,\* it is possible to enjoy reduced maintenance costs. Aside from the cost of the lamps and the labor of replacing them, it is important that the cost of electricity be included as an item of studio expense. The overall cost (less bulbs) of the lighting equipment for Plan "B" can be estimated at approximately \$6.00 per square foot of studio floor area.

**Possible Addition of Remote Facilities to Plan "B"**

It is quite possible that some TV planners utilizing Plan "B", "A-Prime", or even "A" will rely on remote pickups to provide an important part of the station's income. In this event, plans should include garage facilities to accommodate the TJ-53A Mobile Vehicle (see Plan "C"). Also, careful consideration should be given in the selection of the equipment provided in the vehicle since it may well serve as a spare control room, particularly useful for emergency operation.

\* Note that approximately 2900-degree K incandescents and 3500-degree K or 4500-degree K fluorescent lamps are recommended.

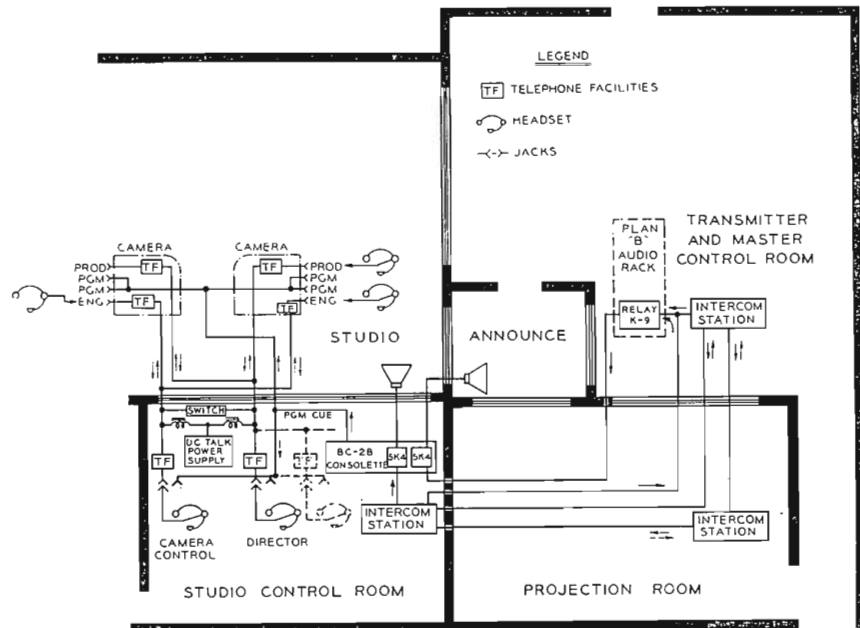

FIG. 42. "Intercom" "flow" diagram for Plan "B" Station.

NOTE: LAYOUT IS SYMMETRICAL, UPPER HALF PLAN BEING CEILING ARRANGEMENT AND LOWER HALF SCENIC

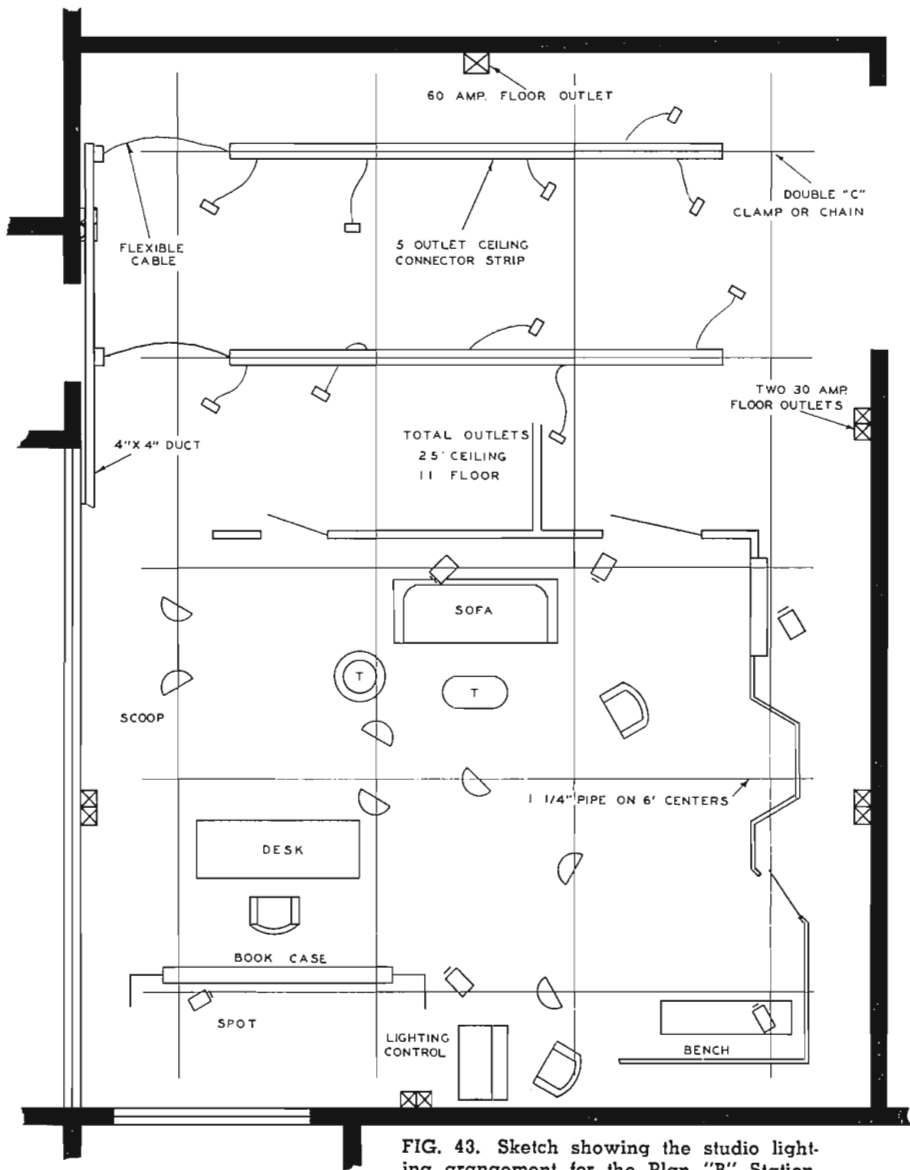

FIG. 43. Sketch showing the studio lighting arrangement for the Plan "B" Station.

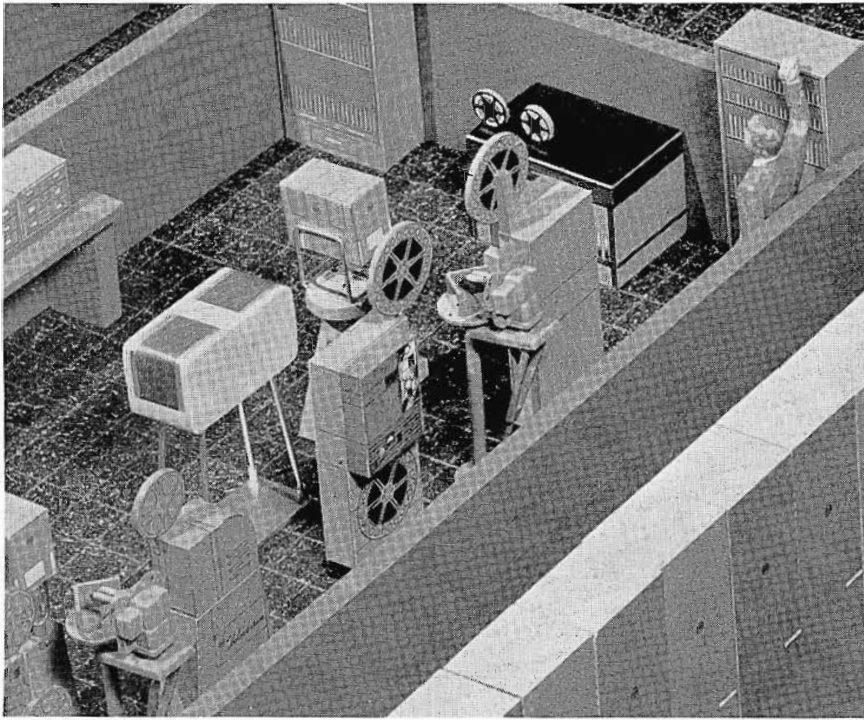

FIG. 40. Closeup showing the model equipment arrangement suggested in Fig. 41. Also note use of new TP-6A Professional Projectors in one grouping.

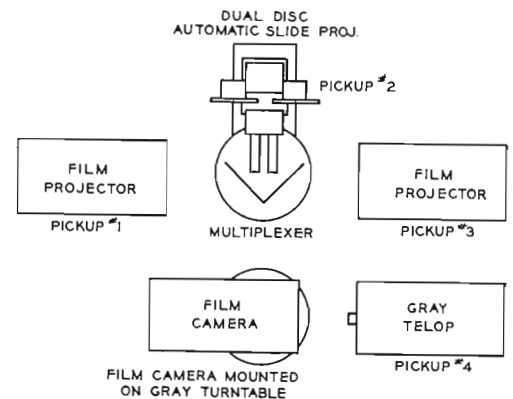

FIG. 41. Sketch showing the optional use of a Gray 556 Turret so that the second film camera may be swung to various picture image sources.

Room and Studio area personnel. Prior to "on-air" periods, members of the technical staff can communicate with one another, as can members of the program staff. At program time, all phones can be tied together by operation of a switch to provide necessary "intercom" between the technical and program staffs (see Fig. 42).

### Plan "B" Studio Lighting

The studio of Plan "B" might be classified as a general utility or "workshop" type of studio. Unlike the Plan "A-Prime" studio, it is capable of handling somewhat more complex programming involving more frequent setup changes. Dramatic, planned, or restricted sequence programs will originate from this (26 by 35 by 14 to 18-foot) studio. The lower half plan of Fig. 43 shows a typical multi-scene dramatic program.

To fulfill the requirements of present and future programming, the lighting arrangement for this studio must be as flexible as possible. As seen in the upper half plan of Fig. 43, a crisscross pipe grid on 6-foot centers and spaced 12 to 14 feet from the floor is used. With such a network and spacing, it is always easy to relocate a fixture on a desired point in a scene. Besides the fixtures themselves, the grid also supports the connector strips and pantograph hangers. Since the latter brings the fixtures within arm's reach, they facilitate the adjustment of fixtures with a minimum amount of time and effort on the part of electricians or other production personnel.

In many instances, it is also convenient to hang drapery or other scenery material from the grid.

Safety and flexibility in the studio wiring system is assured by the use of five connector strips. Each has five pigtail female outlets and is fed from a terminal box on a 4-inch duct through rubber cable. Spaced uniformly on the secondary pipes, they provide 25 ceiling outlets or approximately one outlet for every 30 square feet of studio space. Seven other double outlet circuits are provided 1 to 2 feet from the floor on the walls. The total of 36 branch circuits available make it possible to always find a convenient outlet in the studio. A uniform type of connector throughout the lighting system is suggested to permit interchangeability.

All ceiling and floor outlets are wired to the switchboard where they are switchable or dimmable either collectively or individually, by a patchboard where each outlet is provided with a counterbalanced, retractable cord and male plug. They are patched into the desired bank of grouped female jacks, and, in turn, can be energized by breaker switches. The patching feature makes it possible to group all the fixtures associated with a particular scene to one master and dimmer. Lastly, the studio light control must be capable of supplying 25 KW of fused power or almost 30 watts per square foot of studio floor space.

From an engineering standpoint, the lighting sources must provide the proper

quality and quantity of light needed to produce a good TV picture. Practically, it has been found that incandescents or a combination of fluorescents and incandescents can provide the quality of light to insure proper tonal rendition. The quantity of light reflected from the TV scene must be sufficient to allow the camera to produce a picture of acceptable signal-to-noise ratio.\* The average lighting level is 100 foot-candles, but it is recommended that sufficient sources be available to produce 200 F.C. of incident light in order that there be proper flexibility in control and lens stops.

Artistically, the lighting sources must be capable of fulfilling the following functions: (1) General or Base light, (2) Key light, (3) Modeling light, (4) Back light, and (5) Special Effects light.

Each of these functions of light will be discussed in Plan "C", and it is sufficient at this time to indicate that they can be provided by the various standardized floods and spotlights suggested for Plan "B".

The incandescent scoops or slimline fluorescent lamps provide the soft edge, wide angle beams for base (fill) lighting. Fresnel lens spotlights and elliptical spots provide controllable beams for accent lighting; i.e., key, model, and back light. Special effects such as simulated background scenery can, of course, be provided by

\* BROADCAST NEWS, April, 1949.

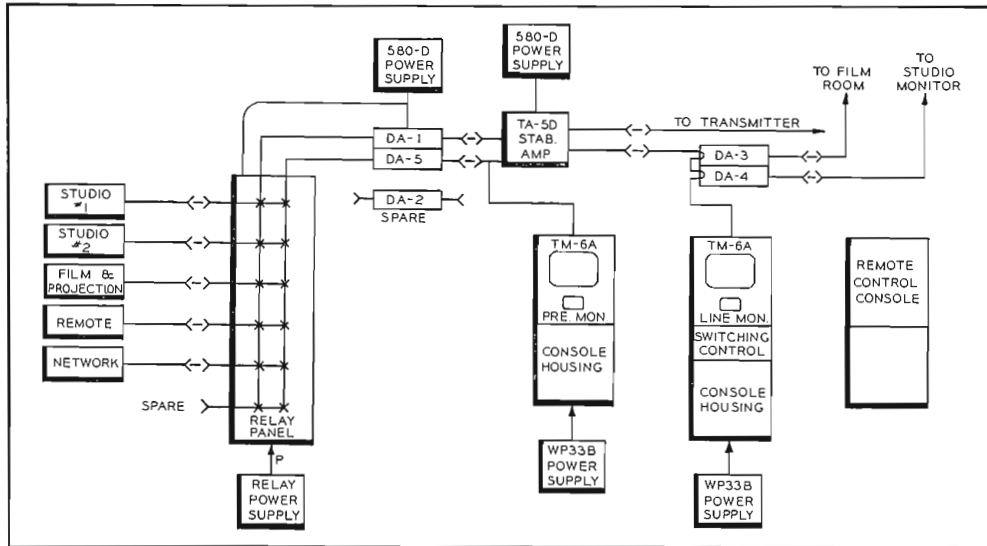

FIG. 38. Diagram illustrating the possible use in Plan "B" of "2 x 6" video-relay switching panel (six inputs and two outputs) for master switching.

size, number of cameras, number of projectors, work benches, clearance space around equipment, film storage facilities, intercom, lighting, film processing (dark room) are all important factors.

### Plan "B" Intercom

The Master Control Room Operator has two-way intercommunication with the Projection Room, Studio Control Room, and talking facilities only to the Announce Booth. During "on-air" periods of the Announce Booth, the "intercom" speaker is automatically muted by utilizing available relay contacts. Optional headphones in the Announce booth can continuously receive from the Master Control Operator, as well as from the Studio Control Director.

The Studio Control Director has two-way "intercom" with the Projection Room, Master Control Room, and talking facilities only to the Announce Booth and Studio. The "intercom" speaker of the Studio is muted in a manner similar to that of the Announce Booth.

The interphone headset facilities are used only between the Studio Control

FIG. 39. Model layout showing a possible arrangement for the film editing and storage, dark room, as well as news room, record library, and small props and costumes.

provided (as is done in Plan "B") for a separate film editing room which is a tremendous asset. In this room, preview projectors, film storage cabinets, viewers and other supplemental storage and accessory equipment can be located.

Serious consideration should also be given to providing a small dark room (see Fig. 39) where local film processing and other photographic processes may be performed when the occasion demands. Perhaps every station in need of dark room facilities will have varying requirements, however, listed here are some of the items that can be considered.

### Description

Eastman Silent 16mm Cine-Kodak special with S 1.9 Lens, 100-foot Chamber.

4 x 5 Crown Speed Graphic Camera with 6 3/8-inch Ektar Lens.

Graflex Flash Gun.

4 x 5 Enlarger—Omega Enlarger D2, no lens/no color head.

6 3/8-inch Enlarging Ektar Lens.

Kodak Professional 5 x 7 All Metal Printer (Bromberger).

Graylack #168 Electric Timer.

Burke and James Rexo Double Duty Dryer. 110 v. d-c, 220 v. a-c, 220 v. d-c.

### Accessories

G. E. Light Meter Model PR-1.

4 x 5 Developing Tank F-R (Finke-Roselieve).

Kodak Stirring Rod Thermometers.

Stainless Steel Trays 11 x 14 inches.

Film Washer—Kodak Automatic Try Siphon.

Because of the importance of the film facilities, all station planning should have careful consideration of every detail. Room

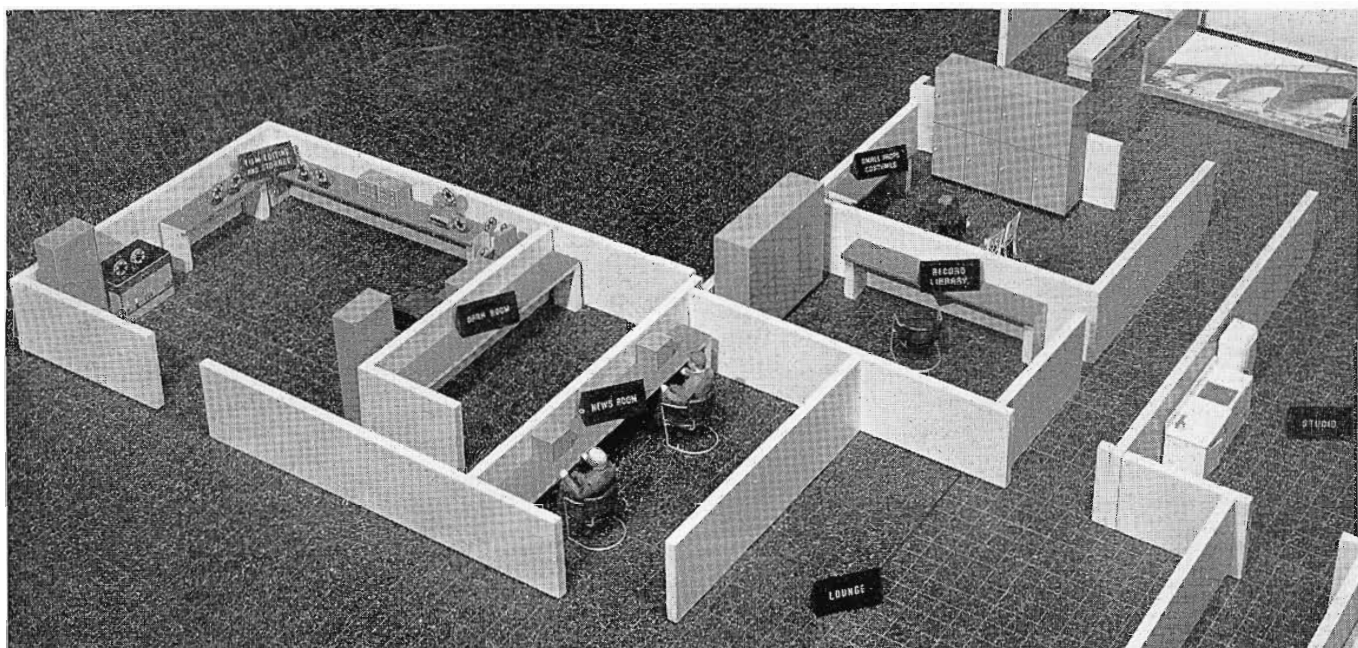

The Plan "C" station can be considered as a prototype for all stations larger than Plan "B". Although Plan "C" is illustrated as employing a minimum of standard video components, many additional innovations and "spare" equipment features can be easily added.

It is apparent from the block diagram of Fig. 51, that a high degree of flexibility

Each studio has its associated control room with elevated platform setups to provide good visibility into programming areas. Space is provided, as in Plan "B", for operation with a program director seated at the TC-5A Console on a platform at a second level, or with the director seated at the same level as that of the video and audio operators in front of a common "in-line" console. (See Fig. 52.)

of a Type BC-2B Consolette, BCS-13A VI and Ringdown Console for the smaller "two-camera" studio. Equipment is located in line with companion video consoles. Mixing and switching facilities are provided by the BC-2B Audio Consolette. Each of its eight possible simultaneous inputs is controlled by a high level mixer. Talkback facilities, turntable mixers with built-in

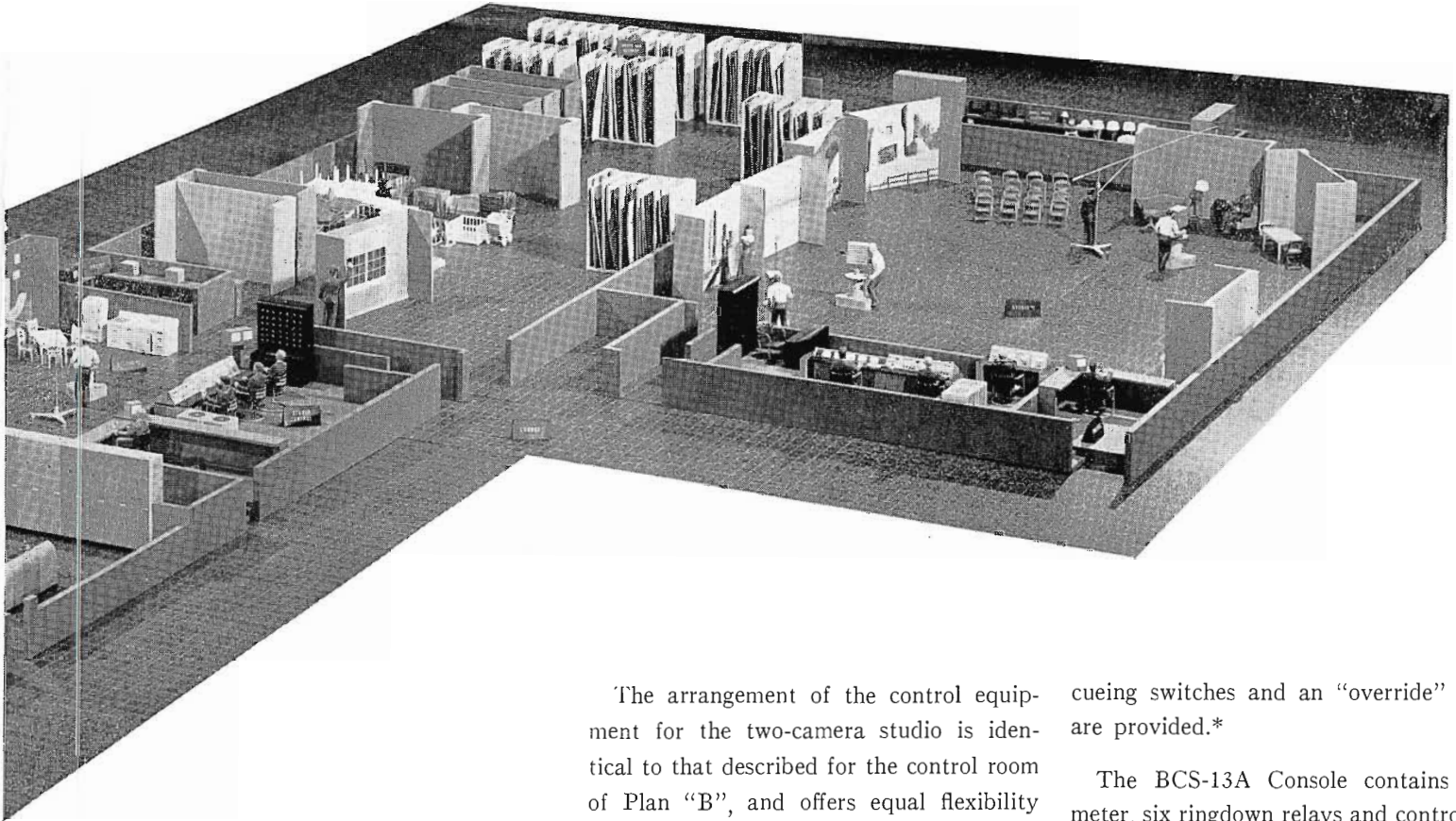

is maintained throughout this system as well as in those previously described.

#### Plan "C" Studios and Studio Control

Plan "C" is equipped with two studios, one large "three-camera" unit and a somewhat smaller "two-camera" unit. Additional microphones (program stand, "hand-held", desk and boom type) are recommended, as are additional studio monitors, and studio loudspeaker for turntable feed and talkback. Since programming for this station is on a much more elaborate scale, the space provided to accommodate properties and sceneries is proportionally larger. Other auxiliary facilities such as record library, dark room and additional offices are provided in this plan.

The arrangement of the control equipment for the two-camera studio is identical to that described for the control room of Plan "B", and offers equal flexibility or choice in mode of operation. Video consoles may be located to suit personal operational preferences. Monitoring, switching and remote control features are all similar and need not be again described. The possibility of employing video-relay switching, as previously described, also applies to the studio control rooms of Plan "C" (see Fig. 55). The "three-camera" studio control room has the same facilities as that of the smaller unit except for the addition of another camera control console section.

#### Plan "C" Audio

The audio control equipment needed to satisfy the requirements of Plan "C" are similar to that of Plan "B" and consist

cueing switches and an "override" switch are provided.\*

The BCS-13A Console contains a VI meter, six ringdown relays and control keys for private line telephone facilities. Turntable outputs can be fed to loudspeakers for vocalist accompaniment or background purposes. A rack of associated equipment for use with the BCS-13A is usually located in the control room.

The larger "three-camera" studio-audio facilities are identical except for the possible addition of the BCM-1A Auxiliary Mixer Console (see Fig. 48) which would provide for the use of any four of twelve additional microphone inputs. It is also mounted alongside the consolette.

\*For complete description of Audio Facilities, see Jan.-Feb. 1951 BROADCAST NEWS, "A Flexible TV Audio System" and July-Aug. 1951 BROADCAST NEWS, "A New AM-FM-TV Console."

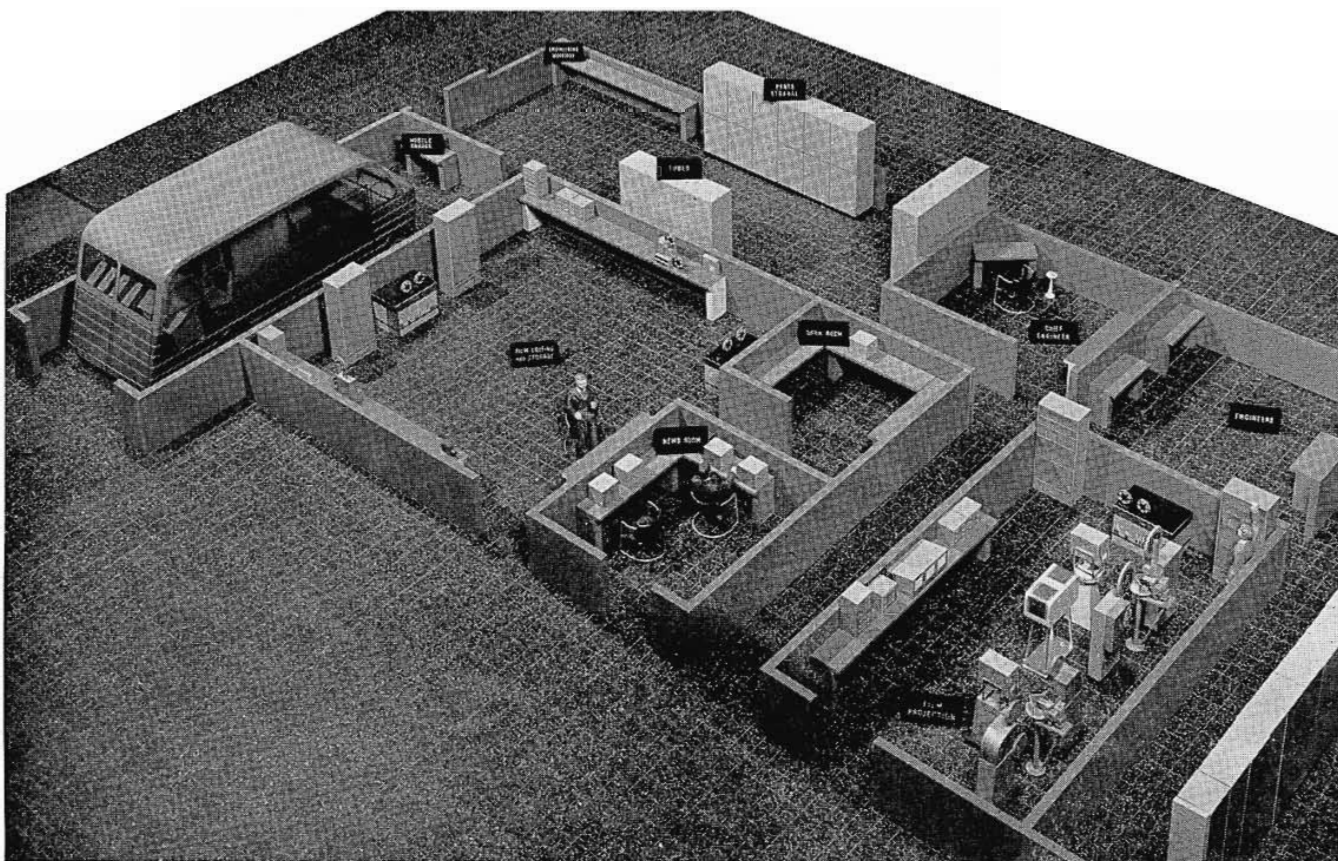

FIG. 45. Closeup showing the "left-hand" portion of the Plan "C" Station, including mobile unit, film editing and storage, news room, dark room, parts storage, film projection room, engineering workshop and engineers' offices.

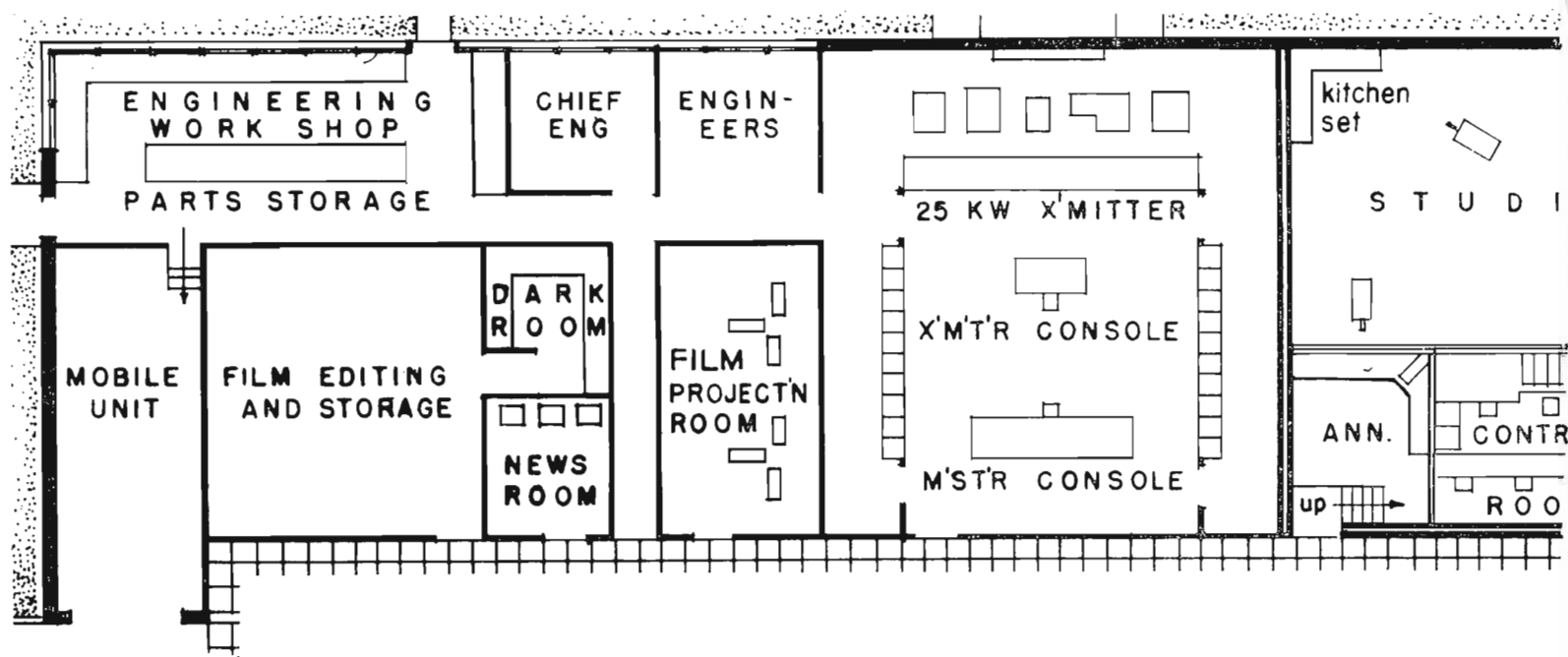

FIG. 46. Floor plan layout showing the technical facilities for the Plan "C" Station.

### Plan "C" Master Control

Referring to the floor plan of Fig. 46, it will be noted that there are two studios; one large, with its associated control room and a smaller studio with its control room. There is also a film projection room with its associated controls located in the master control room (see Fig. 47).

Each studio is a complete unit capable of producing live talent shows. The output from the film controls, as well as from

each studio, and signals from networks and remote pickups are routed through master control.

Facilities are available for handling a number of remote signals by telephone company lines and by microwave relay. Stabilizing amplifiers are available on the same jack panels as the incoming signals so that they can be connected into the circuits. The stabilizing amplifiers are designed to set the proper synchronizing-to-

picture ratio and to improve the quality of the synchronizing signal of incoming remotes. The stabilizing amplifier utilizes clamp circuits to remove hum, bounce, and other line disturbances.

The relay receivers and the stabilizing amplifiers are rack-mounted in the master control room and their remote controls are brought to a console section for convenience in setting-up and operating the equipment. Each of these pieces of equip-



ment has two outputs available at jack panels so that signals can be fed to the master switching system or to the studio camera switching system independently. In master control, the desired signal can be fed to any one of the outgoing lines.

Here again, it should be understood that the same arrangement of equipment as that outlined in Plan "B" may be used.

**Plan "C" Master Relay Switching**

The use of more inputs, sync interlock, and shorter coax cable runs fits in naturally with relay switching, which makes

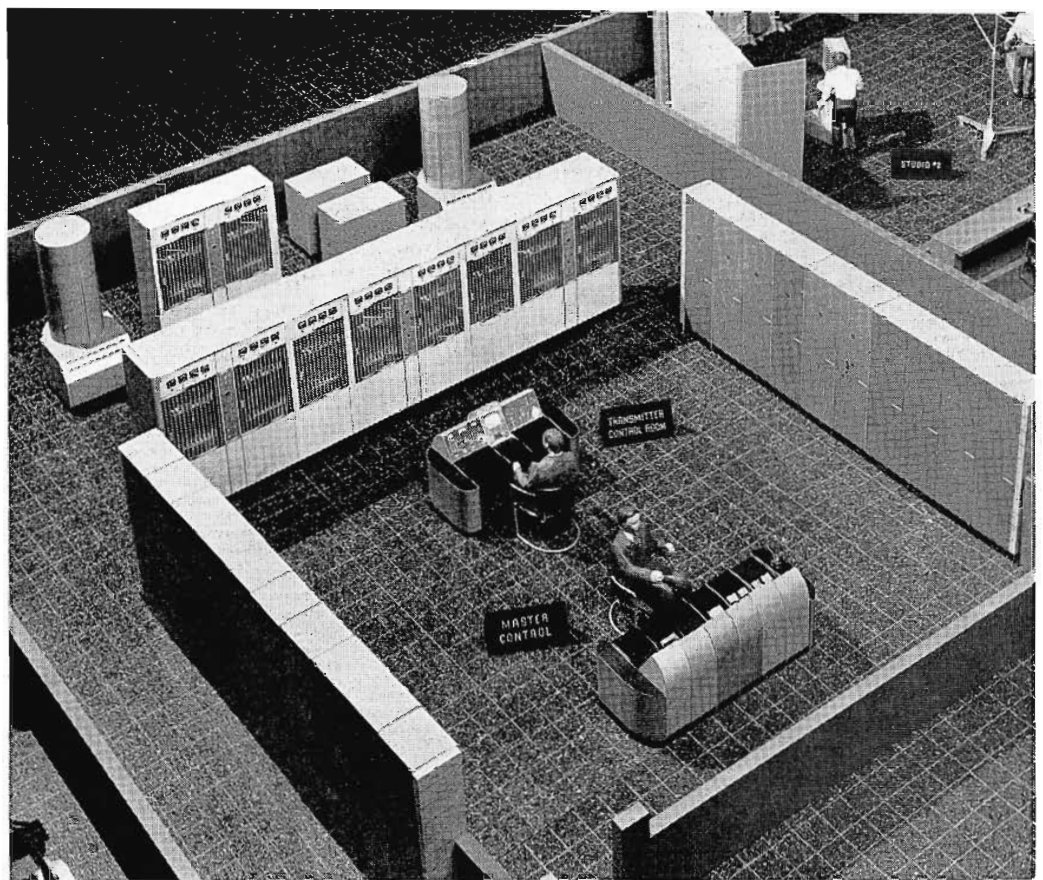

FIG. 47. View of the central part of Plan "C" showing the use of an RCA, 25-KW VHF Transmitter. Note that power amplifier, power control, switchgear and distribution equipment are located at the rear of the transmitter. A separate transmitter supervisory console is employed in Plan "C"; a video/audio console and associated rack equipment are also located at the same "master control" point, as shown.

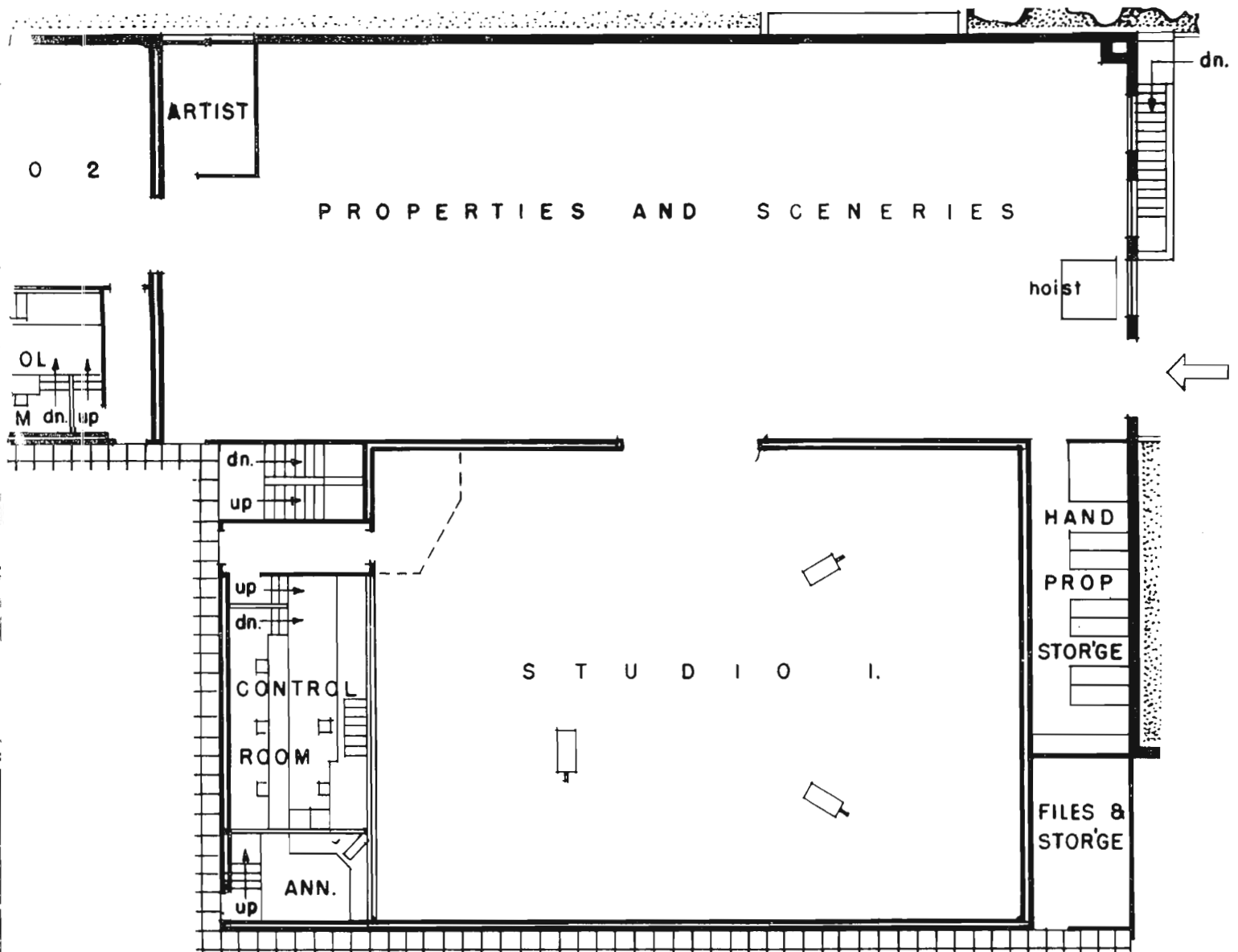
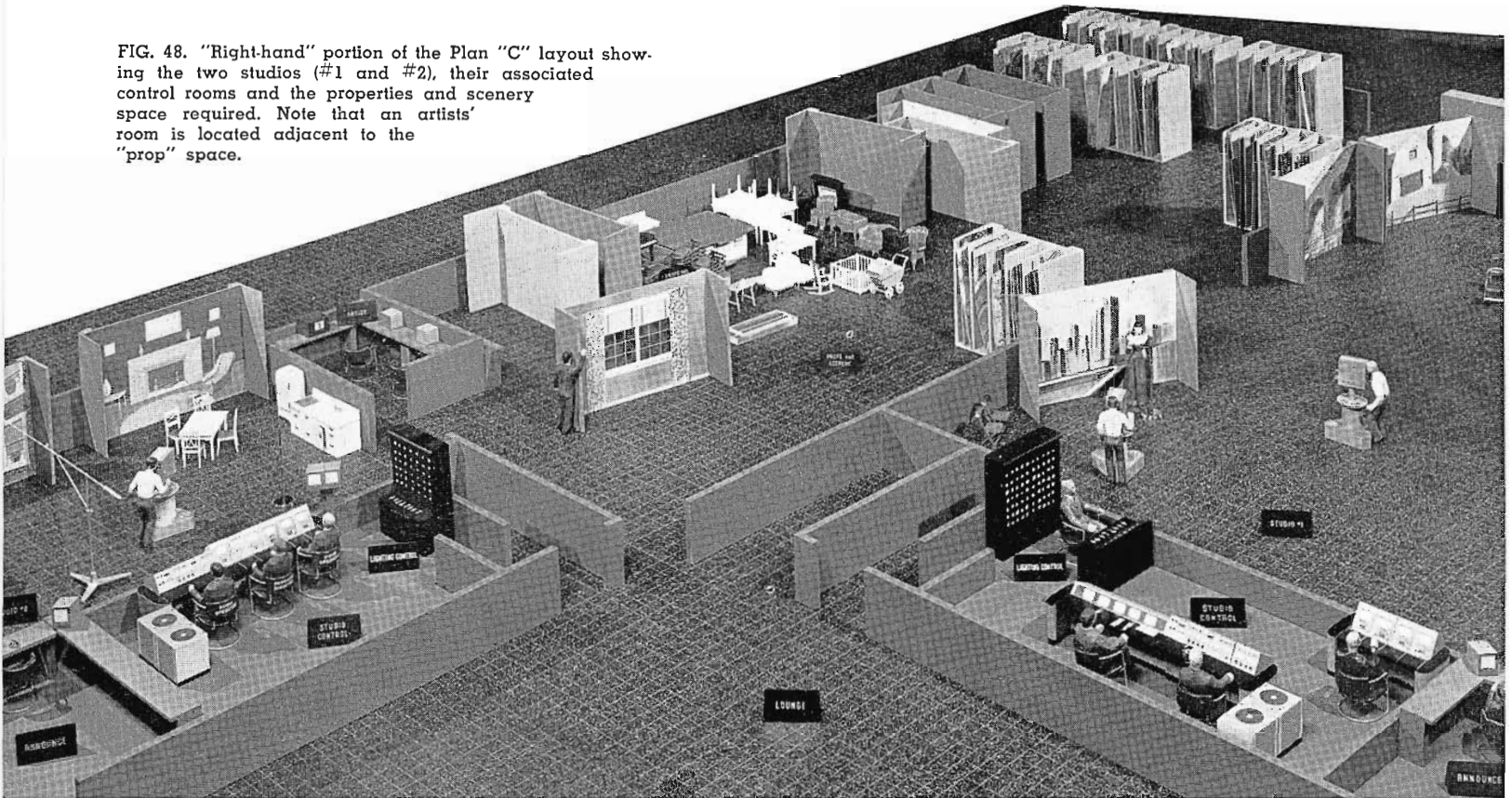

FIG. 48. "Right-hand" portion of the Plan "C" layout showing the two studios (#1 and #2), their associated control rooms and the properties and scenery space required. Note that an artists' room is located adjacent to the "prop" space.



programming smoother and easier. It also provides a means of switching audio and video simultaneously, and includes a greater number of tally light controls necessary in larger operations.

A simple relay switching system is one comprised of six inputs and two outputs (see Fig. 38).

For a more comprehensive system, it is possible to extend functions to twelve in-

puts and six outputs. For an operation of this size, requirements usually become more involved than those previously mentioned and should be discussed at length with a systems planning group.

There are many who feel that their programming requirements are such that some means of switching and fading should be included in Master Control (particularly where it is desirable to superimpose local advertisements on network programs). In

such instances, a system using the TS-10A Studio Switcher, the TS-30B Field Switcher, or a video relay system in conjunction with the "Genlock" is necessary. The output, of the system chosen, could be fed into one of the Master Switching inputs mentioned earlier.

All switching for the station (including studio camera switching) may be accomplished by relays located in the Master Control Room. Video signals, local and

FIG. 49. Rack layout showing arrangement of video amplifiers, sync generators, audio and monitoring equipment.

SYNC. GENERATOR NO.1 TYPE TG-1A	SYNC. GENERATOR NO.2 TYPE TG-1A  SYNC. GEN. SWITCH	DISTRIB. AMPLIFIER PULSE	RELAY RECEIVER CONTROL	BLANK PANEL	DISTRIB. AMPLIFIER	DISTRIB. AMPLIFIER	GR-1183 FREQ. & MOD. MONITOR EQUIP VISUAL & AURAL IN TOP 3 PANELS	BLANK	
		DISTRIB. AMPLIFIER PULSE	MONOSCOPE CAMERA	STAB. AMP STUDIO A				BLANK	
		DISTRIB. AMPLIFIER PULSE	GRATING GENERATOR	DISTRIB. AMPLIFIER	DISTRIB. AMPLIFIER	STAB. AMP TC 4 A		GR-1170-BT FM MONITOR	BX-1E   BA-13A PRE-AMP   LINE P.S.   AMP.
		DISTRIB. AMPLIFIER PULSE	STAB. AMP TS10A	MIXER AMP BLANK PANEL	BLANK PANEL	BLANK PANEL		GR-1176-AT VIS. FREQ METER	BA-6A LIMITING AMP
		GENLOCK	STAB. AMP NET	BASIC RELAY CHASSIS	VIDEO JACK PANEL	VIDEO JACK PANEL		GR-1171-AT FREQ MONITOR	AUDIO JACK PANEL
		BLANK PANEL	STAB. AMP REMOTE	AUX RELAY CHASSIS	VIDEO JACK PANEL	BLANK PANEL		BLANK	B.P.MI-4590-A
		BLANK PANEL	BLANK PANEL		BLANK PANEL	DISTRIB. AMPLIFIER		BLANK	BA-11A PRE- AMPLIFIERS
						DISTRIB. AMPLIFIER		BLANK PANEL	16MM SOUND EQ.
				DISTRIB. AMPLIFIER	CKT. BKT.	BA-14A AUDIO MON AMP			
					CKT. BKT.	BX-4A RELAY P.S.			
					CKT. BKT.	BLANK PANEL			
						MI-4594-B			
						BLANK			

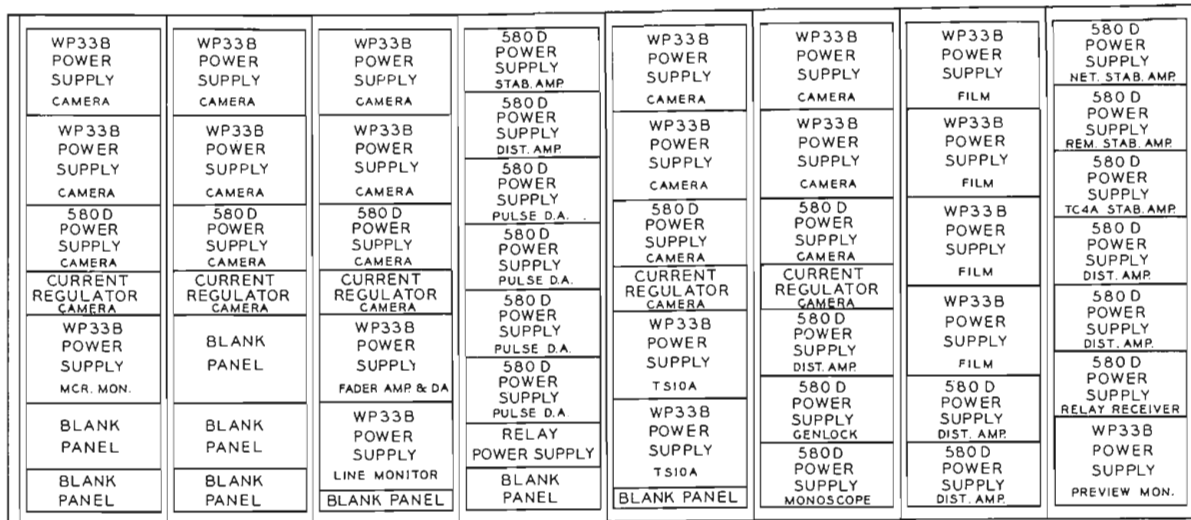

FIG. 50. Rack layout of the power supply equipment for Plan "C".

FIG. 51. Overall video system schematic of Plan "C" showing the interconnection arrangement of equipment units. Audio components for TC-4A, not shown, are like those of "A-Prime" (see Fig. 20).

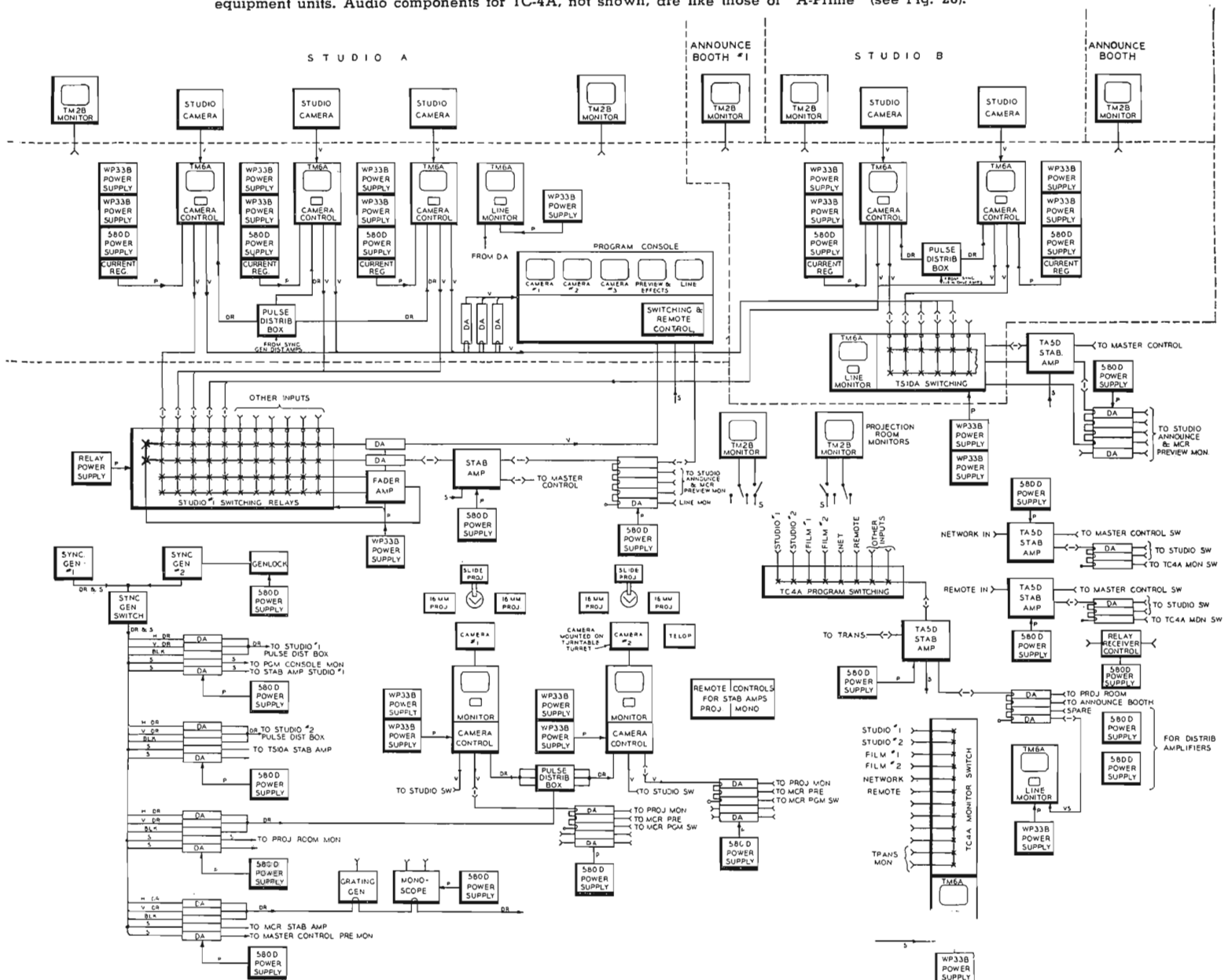



FIG. 52. View of large Studio #1, companion control room and the nearby "prop and scenery" storage area. Note that, in this setup which uses the TC-5A Program Director's Console, the video monitors have been located away from the control room window. The program director and audio operator are at a second level, with the lighting control operator and his equipment plus the video monitors at a lower level. (Actually these camera controls could be located in a different room.)

remote, are fed to jack panels where they can be connected through to the corresponding video switching relays. These relays are controlled from pushbuttons located in the various switching positions. Each studio control room has associated with it four banks of interlocked relays, two for the fader amplifier and one for the preview monitor and one for the program line and monitor. Two synchronizing generators (one a spare) are provided in the Master Control Room with a switch to select the desired generator for use (see Fig. 14). This then feeds distribution amplifiers to distribute the blanking, driving, and synchronizing signals to the various parts of the system. In case the differences in physical separation of the Master Control Room and the individual studio control room is great, delay compensation can be inserted between the sync generator and the various distribution amplifiers.

This overall system is extremely flexible as it provides numerous combinations of camera facilities for programming and rehearsal. Cameras and remotes can be patched into any studio switching system

so that the program director at his console in a studio control room can have complete control over the switching of any studio cameras, film cameras, or remotes that he may require to make up a given program. A complete film program can be run entirely from the Master Control Room when so required. In this way, the facilities of an individual studio may be used for rehearsals while another studio or film is put on the air. One film chain may be used for a program while other film is previewed in a client's room without interference. Thus, almost any combination of facilities may be used to suit the particular requirements that may arise.

#### Plan "C" Intercom

The Master Control Operator has two-way intercommunication with the Projection Room, Studio No. 1 Control Room, Studio No. 2 Control Room, and talking facilities only to Announce Booth No. 2. During "on-air" periods of Announce Booth No. 2, its intercom speaker is automatically muted by utilizing available contacts of the Announce Booth No. 2

speaker muting relays. Optional headphones in Announce Booth No. 2 can continuously receive from the Master Control Operator as well as from the Studio No. 2 Control Director.

The Studio No. 1 Control Director has two-way intercommunication with the Projection Room, Master Control, Studio No. 2 Control, and talking facilities only to Announce Booth No. 1 and to Studio No. 1. During "on-air" periods of Announce Booth No. 1, its intercom speaker is automatically muted by its relay (see Fig. 57). During "on-air" periods of Studio No. 1, its intercom speaker is muted by its relay.

The Studio No. 2 Control Room Director has "two-way" intercommunication with the Projection Room, Master Control, Studio No. 1 Control, and talking facilities only to Announce Booth No. 2 and Studio

FIG. 54 (at right). A view of Studio #2 and Studio #2 control room showing a possible two-level arrangement, with TC-5A and Audio at upper level, video monitors below, and lighting console in the studio.

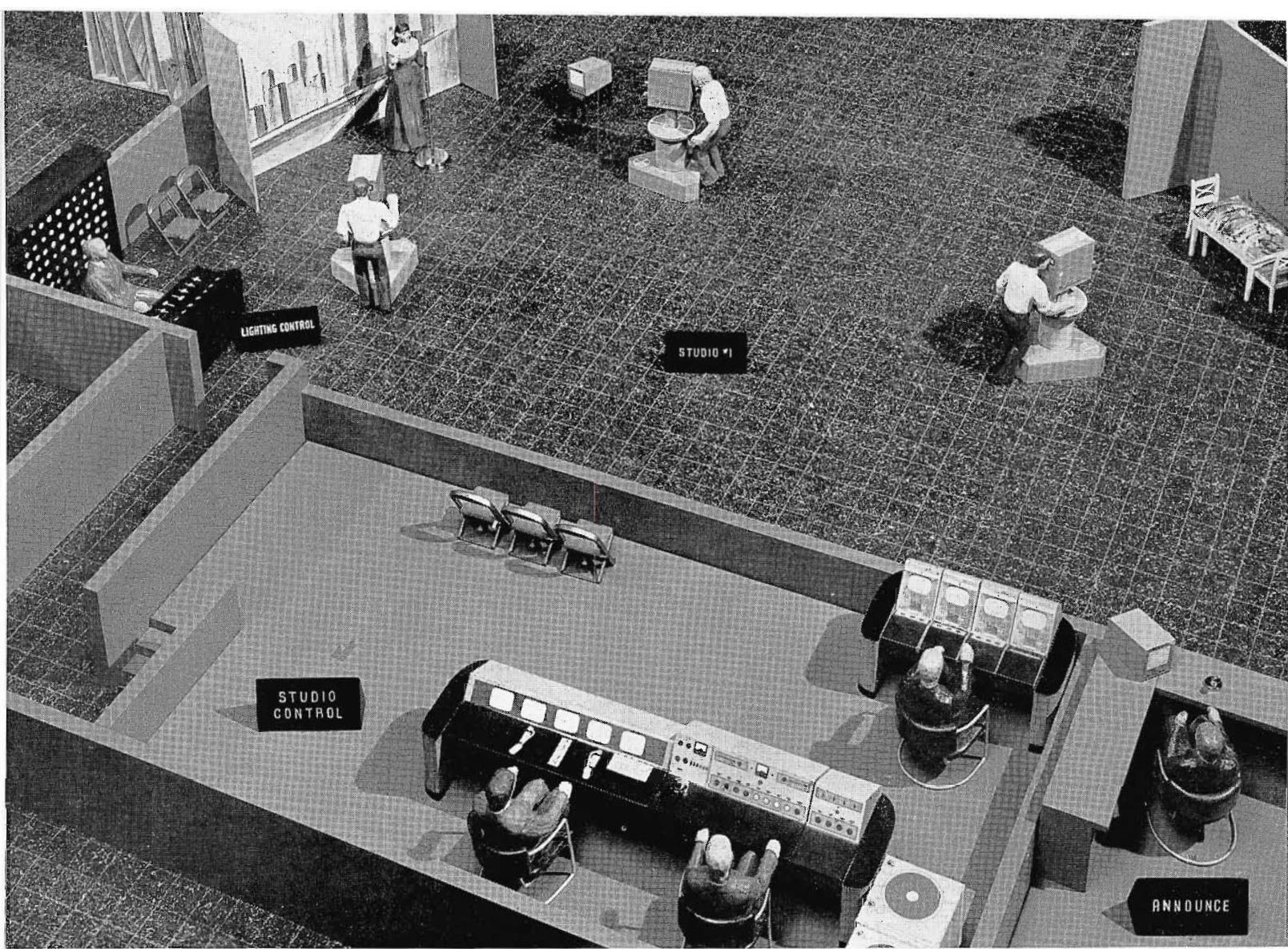
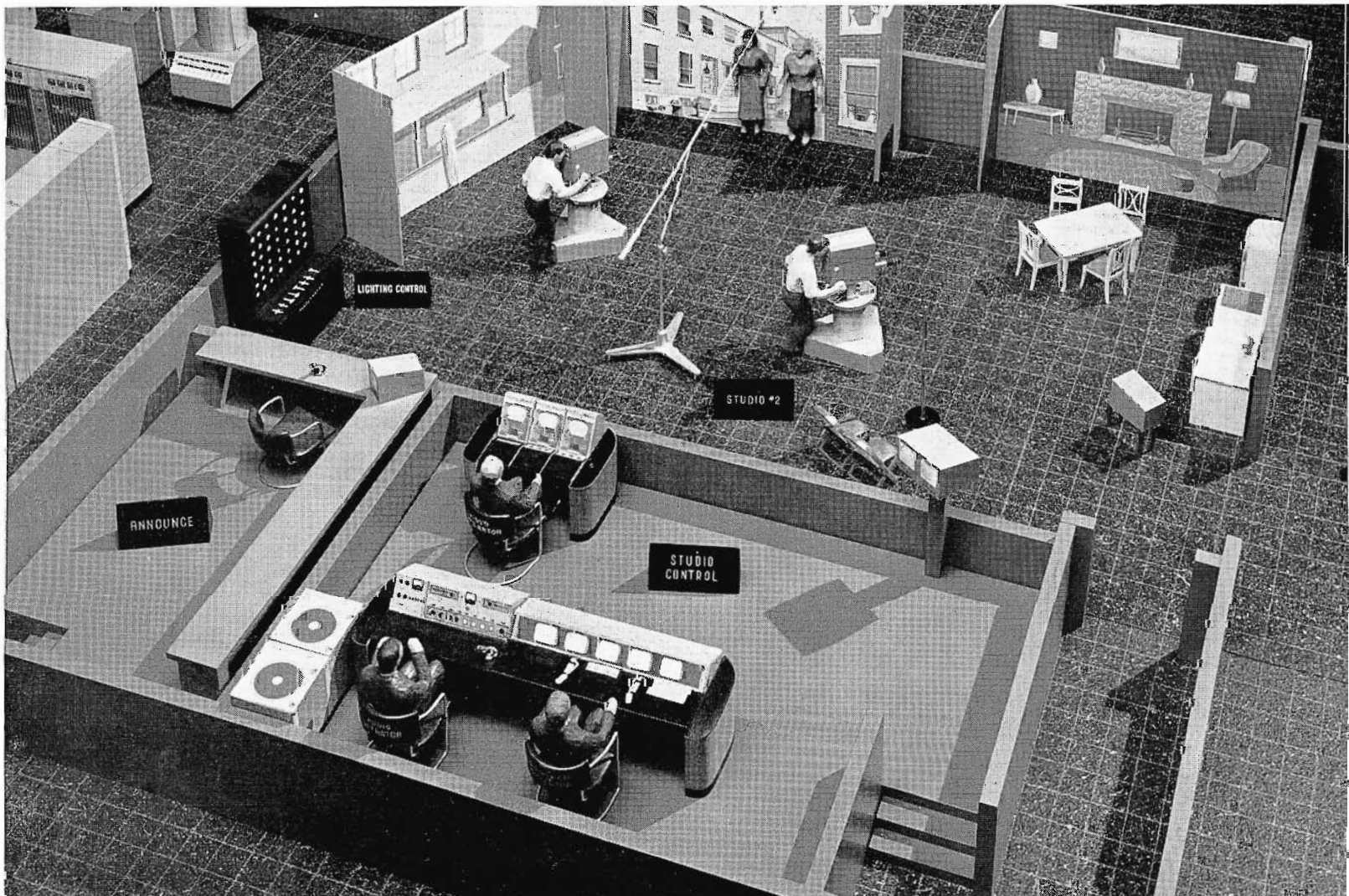

FIG. 53 (above). Another arrangement of the Studio #1 control room in which the lighting control operator and his console are moved into the studio.



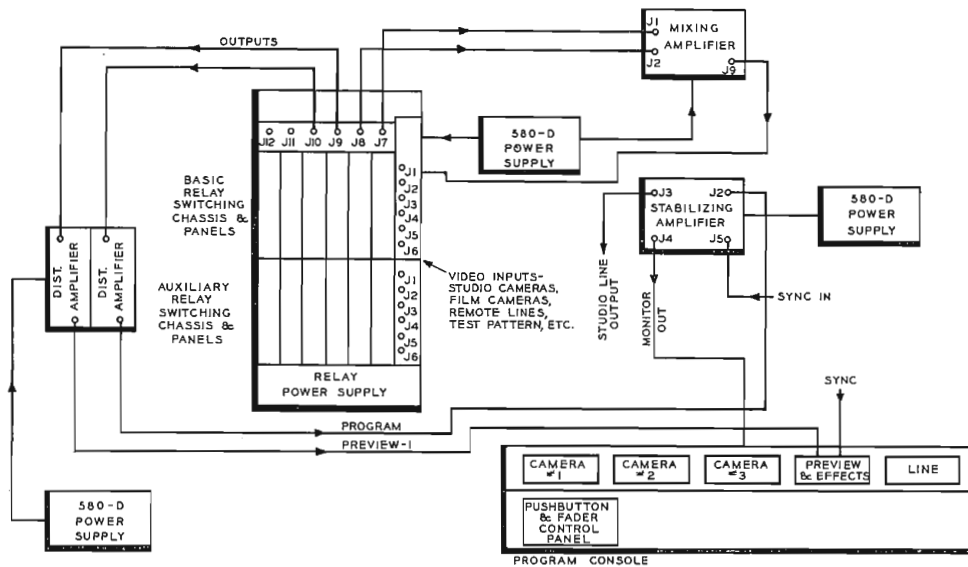

FIG. 55. Diagram illustrating the use of the TC-5A Program Director's Console and video-relay switching in the studio control rooms of Plan "C".

No. 2. During "on-air" periods of Announce Booth No. 2 or Studio No. 2, the intercom speaker would be muted for "on-air" areas.

**Plan "C" Remote Facilities (Mobile Unit)**

Plan "C" includes complete garage facilities for the Type TJ-53A Mobile Unit which permits the "C" station to in-

clude "remote pickups" in its programming plans (see Fig. 58). This 1½-ton mobile vehicle answers the remote needs admirably and serves as a spare studio, always ready to move when needed.

It houses the essential equipment for a remote pickup: cameras, sync generators, switching facilities, power supplies, and a means for relaying picture information back to the station. Those items normally

operated from the control room, such as camera controls, are transported in their operating position. Other items such as cameras, tripods, dollies, cable reels, and microwave transmitters have space allotted inside the vehicle for transportation. Outside doors to the storage cabinets permit direct side-loading of all heavier equipment. The inside of the Mobile Unit is divided into two separate and distinct compartments: an operating compartment and a storage compartment. The entire front section is the operating or control room and is separated from the storage section in the rear by a partition fitted with a sliding door. Entrance to the control room is through the front side doors. The door windows and windshield may be readily covered by a curtain secured with snap fasteners to exclude outside light. Forward in this compartment are two cushioned chairs, one located in the driver's position and the other alongside it on the curb-side. The curb-side chair is rotatable and may be used to provide a seat for the Program

FIG. 56. An alternate arrangement of the master control/transmitter control room using the RCA TT-50AL (50-KW, VHF Transmitter). Note that the power amplifiers, control, switchgear, distribution and transformer equipment are located at the rear of the transmitter. The film projection room is visible at left.

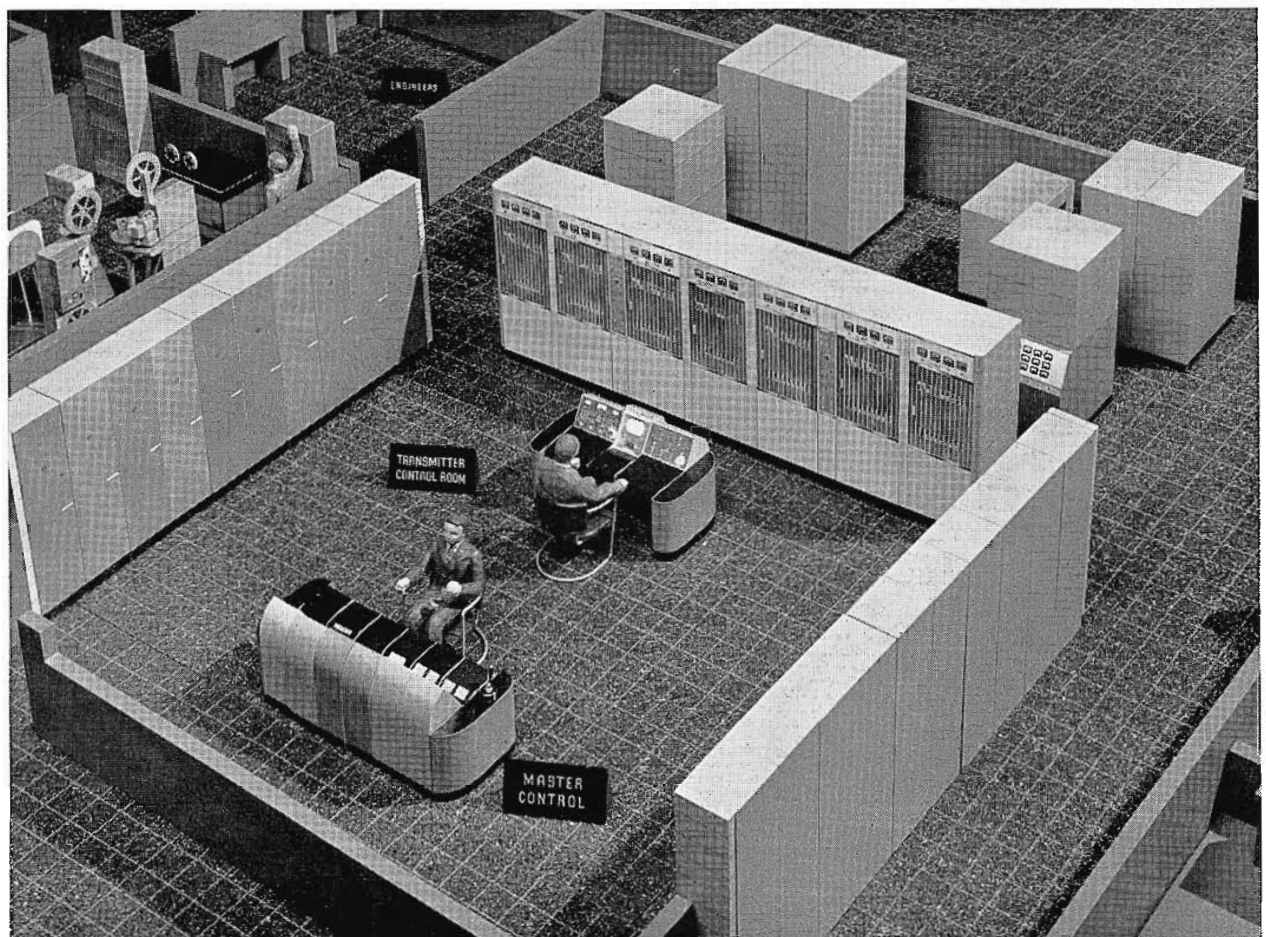
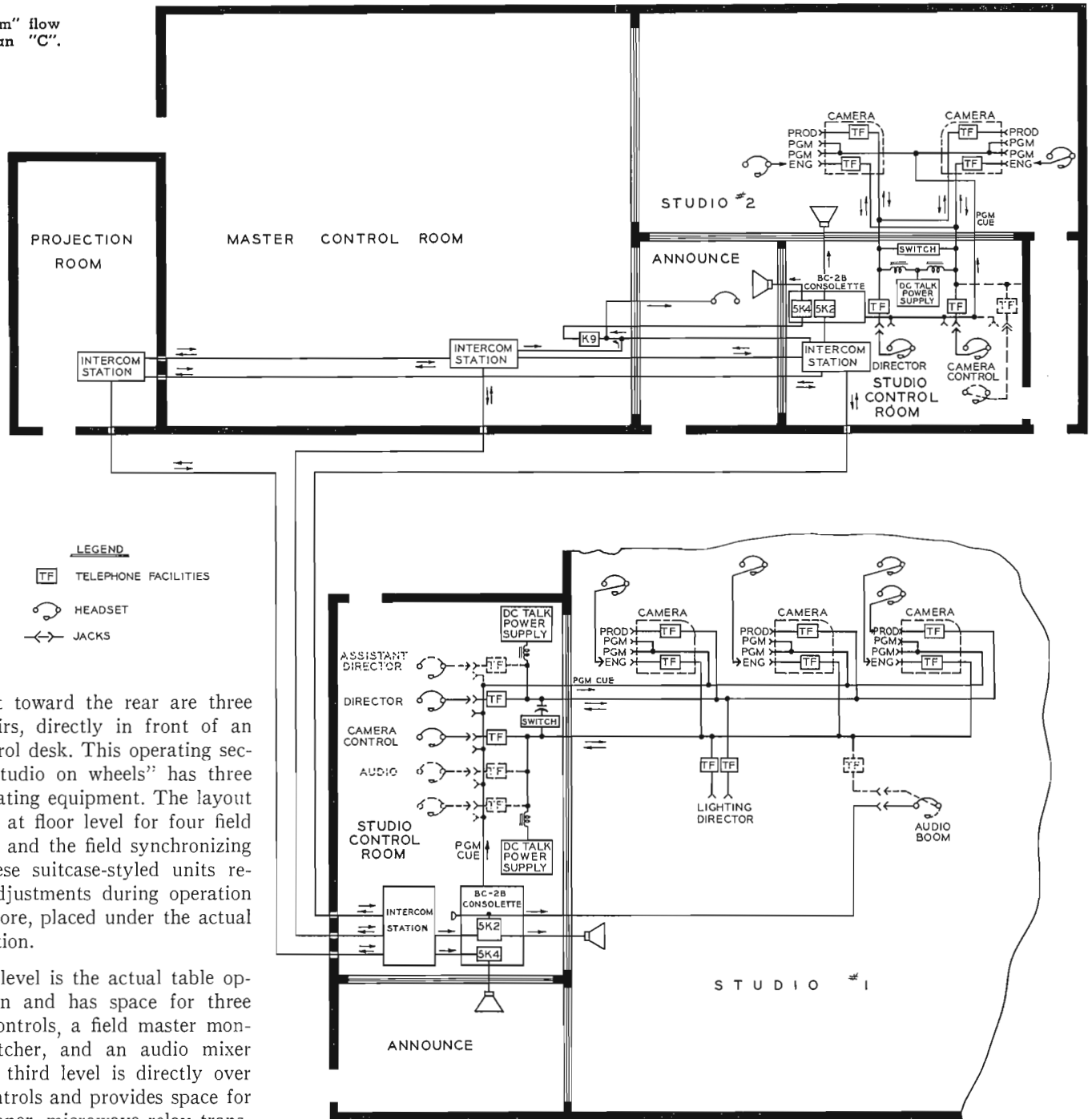

FIG. 57. "Intercom" flow diagram for Plan "C".



**LEGEND**  
 [TF] TELEPHONE FACILITIES  
 [Headset symbol] HEADSET  
 [Double arrow symbol] JACKS

Director. Next toward the rear are three cushioned chairs, directly in front of an operating control desk. This operating section of the "studio on wheels" has three levels for operating equipment. The layout provides space at floor level for four field power supplies and the field synchronizing generator. These suitcase-styled units require a few adjustments during operation and are, therefore, placed under the actual operating position.

The second level is the actual table operating position and has space for three field camera controls, a field master monitor, field switcher, and an audio mixer amplifier. The third level is directly over the camera controls and provides space for the air conditioner, microwave relay transmitter control, and power control panel. The roof is reinforced to support the weight of personnel and operating equipment such as cameras and tripods.

**Plan "C" Studio Lighting**

The basic station of Plan "C" is characterized by two studios. The "Studio 2" (of 25 x 50 by 19-foot ceiling dimensions) will originate small scale programming which may be repetitive in nature. As such, its facilities can be patterned after those of the 26 x 35-foot, Plan "B" studio.

The larger "Studio 1", on the other hand, will offer even greater versatility. As a general purpose or workshop studio, it will originate a variety of dramatic

shows, commercial sequences, and any number of musical and speech groupings.

**Lighting System**

The maximum mobility in scene changes and camera movements essential to this type of studio is obtained with the lighting system shown in Fig. 59. Having a 50 by 70-foot working space, "Studio 1" requires a total of 122 branch circuits or approximately one for each 30 square feet of floor area. Branch circuits may be grouped as the scenery requires by means of a patch or rotary selector board, and they, in turn, are switched and dimmed at the control board which is capable of

at least 600 amperes total load. Ceiling connector strips are fed from a 4 by 4-inch direct running the full length of the studio center and a number of floor outlets are adequately dispersed about the studio perimeter.

For greater flexibility, adjustable pipe battens are recommended when the studio height is at least 27 feet. Rope or wire cable is used to connect the 1 1/4-inch iron pipe to the side of the studio and is run down to a tie board or load. Adjustable weights should be used to counterbalance the load on the batten. The ceiling connector strips, at the same time, can be

FIG. 58. Overall view of TJ-53A Mobile Unit used to provide complete facilities for remote pickups.



attached to the battens and energized through draped lengths of flexible cable to a terminal box on the main feedline duct.

Such a grid system makes possible the suspension of backdrops and adjustment of the fixture level for varying "scenery-set" heights (see Fig. 60). Low front-light, from fixtures mounted on this counterweighted batten, makes it possible to minimize facial shadows and avoids the microphone boom shadow. Lastly, rapid and safe manipulation and maintenance of the lights is made possible. Their combined use with a non-swaying pantograph hanger enhances the vertical adjustment of single fixtures while maintaining others fixed on any one batten.

Equally as important as the manipulation of the lighting system is the proper choice of beam pattern and fixture. Such can be easily studied by an investigation of the techniques of lighting.

#### Studio Lighting Techniques

Every television lighting system should be capable of providing the following functions:

1. Base or General Lighting.
2. Modeling Lighting.
3. Back Lighting.
4. Effects Lighting.

*Base lighting* is that uniform, wide angle illumination which covers the whole scene to be televised and which should establish the mood, i.e., daylight, evening, interior,

exterior, etc. The minimum level is limited to a value which will produce an acceptable signal-to-noise ratio. The actual value of incident light required is also determined by the depth of field and normally ranges from 6 to 120 foot-candles for average lens stops. Productions may require even greater variations than this, and for our plans, we will specify 100 foot-candles for an average interior. This base or general light can be provided by incandescent floods (scoops), long range scoops, or banks of fluorescent lamps. *Base lighting* can also be obtained by using the fresnel spots placed overhead at sharp angles.

*Modeling light* is directional light at an angle to the camera axis which develops forms in the scene. Such light can also project through a window, open door, or fireplace to the subject or main acting area. Shadows are then produced, and give an illusion of depth to the subject. This can be obtained by unbalanced base light without destroying the illusion of the space effect. More generally, however, Fresnel lens spotlights provided with diffusers and barn doors can effectively create the form and enhance the appearance of the scene. The intensity of this lighting should be 20 to 30% greater than the base light in the scene.

*Back lighting.* The purpose of back lighting is to separate the actors from the background, and, therefore, strip lights projecting from the floor can also

be used. The level of this backlight should approach an intensity 50% greater than that of the base light, and should be applied with caution since light should never enter the television camera lens.

*Effects lighting* is specialized lighting which injects reality to the televised scene. Such effects as clouds, snow, rain, lightning, firelight, and window light can be obtained by rear projection or by simple silhouettes in front of a light source. Many types of lighting equipment are available for other special beam patterns. The background projector has been used more recently. It can project a simulated background which may be stationary as produced from a slide or moving objects from motion picture film. For proper picture quality, the highlights thus projected should be equal to or at least half of those of the live scene highlights.

The proper combination of these various functions of light can give the illusion of three dimensions to the television picture and impart the desired artistic results. Complete flexibility in all phases of the lighting system will be necessary for the techniques of present day television.

#### CHECK POINTS AND PRECAUTIONS IN USE OF PLANS

To present all of the equipment planning considerations necessary in the proposed construction of a Television station would be beyond the intended scope of this article and, further, would require an exces-



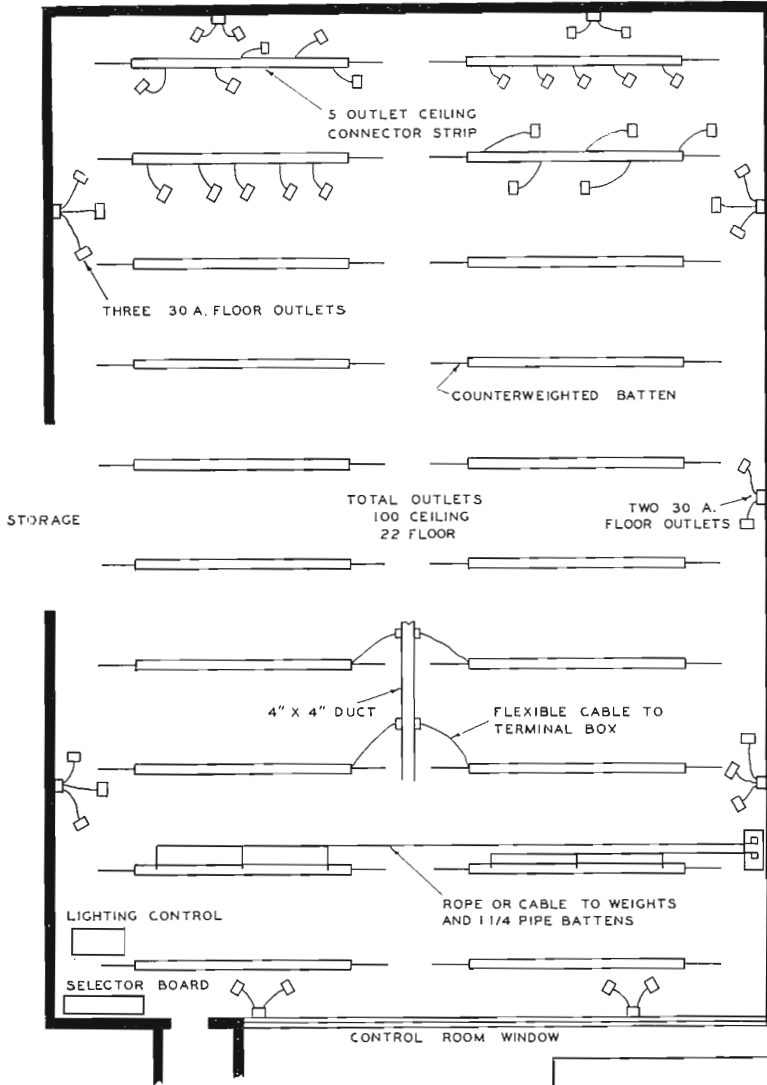

FIG. 59. Studio #1 lighting plan for the "C" Station. The lighting for Studio #2 is similar to that of the Plan "B" Station. (See Fig. 44.)

9. Control room and master control arrangements.
10. Extent of film programming.
11. Film previewing, processing, editing and storage.
12. Clients' rooms.
13. Audience participation space.
14. Provide enough monitors to achieve smooth program performance.
15. Check necessary Audio and Intercom facilities.
16. Studio lighting.
17. House monitoring systems.
18. Mobile unit for remotes.

**Acknowledgment**

The authors wish to express appreciation to those assisting in this project, especially to E. G. Keith, R. J. Smith, and J. S. Almen of the Broadcast Section, RCA Engineering Products Department.

FIG. 60. Plan "C" studio arrangement for proper ceiling height to permit varying "scenery set" heights.

sive amount of editorial space. However, it is recommended that the following "check points" be kept in mind. It is further recommended that the services of a qualified Engineering Consultant be obtained to assist in this development of the basic planning and preparation of an application in its final form for presentation to the FCC.

1. Effect of future expansion of operations.
2. Transmitter Power Increases.
3. Site selection, antenna heights, and coverage for UHF.\*
4. Provide good power source.
5. Trench or duct layouts.
6. Floor loadings.
7. Check sizes of doorways to permit entrance of individual equipment units and scenery.
8. Avoid TV operation in vicinity of AM station or other interference generators.

\* "UHF in Portland" by John P. Taylor, Sept.-Oct. 1952, BROADCAST NEWS.

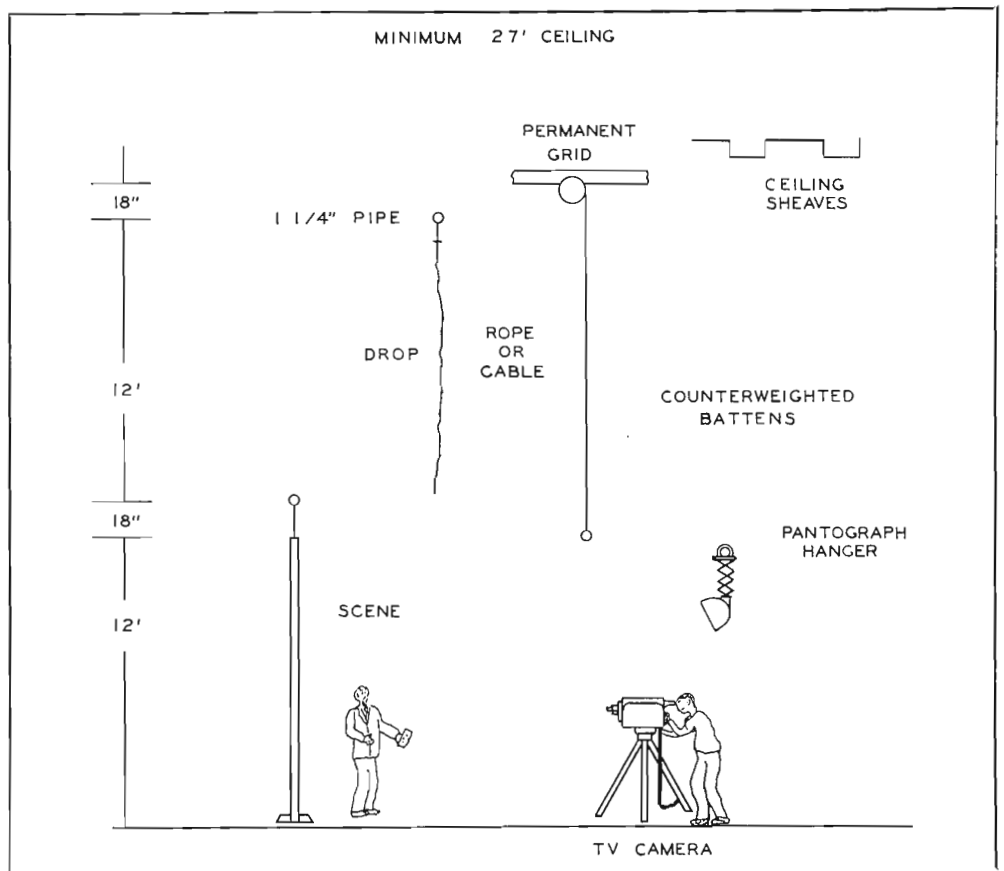

# FIELD INTENSITY METERS AND R-F TEST SET FOR TELEVISION

By IRL T. NEWTON, JR.  
Broadcast Product Planning

The new line of RCA Field Intensity Meters is built around instruments designed specifically to fill the needs of the Broadcast Services, i.e., Standard AM, FM and Television. For Standard Broadcast, the WX-2C light weight portable Field Intensity Meter has been the standard of the industry for several years. The latest addition to this line is the new BW-7A for VHF Television and FM, and shortly to be released is the BW-3A for UHF Television.

## BW-7A for VHF Television and FM

The Type BW-7A is a complete R-F Test Set designed to fill a very definite place in the VHF measurement field. It combines in one instrument a field intensity meter which is more accurate and more convenient to use than any heretofore available, a standard signal generator of laboratory quality continuously metered, and a laboratory quality receiver continuously tunable from 54 to 230 megacycles. The BW-7A R-F Test Set will set a new standard of accuracy for field-strength, gain and attenuation measurements in the VHF region. It is a worthy successor to the WX-1A Field Intensity Meter, now discontinued, and was developed and manufactured for RCA by the same organization—Clarke Instrument Division of National Electrical Machine Shops, Inc.

The combination of an accurate signal generator, which can be operated simultaneously and independently, in the same case with a fine receiver results in a test instrument of exceptional utility. For example, in addition to Field Strength measurements, gain, attenuation and slotted line impedance measurements may be made by having available in one self-contained package both the exciter and supersensitive receiver and measuring circuit. Another example of the utility and flexibility of this instrument would be its use in measuring the characteristics of antennas within its frequency range. The signal generator has sufficient power to excite the antenna under measurement over a very considerable length of transmission line with the receiver being used in conjunction with a simple antenna to receive the radiated signal and measure it in known values over a very wide range.



FIG. 1. View of the BW-7A Combination Field Intensity Meter and R-f Test Set which comes supplied with a convenient carrying case.

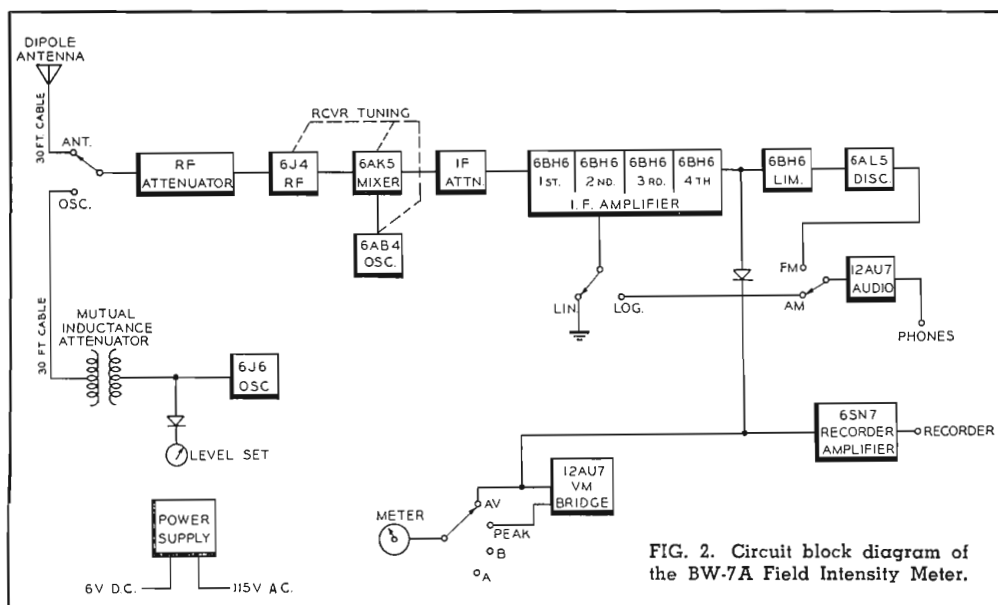

FIG. 2. Circuit block diagram of the BW-7A Field Intensity Meter.

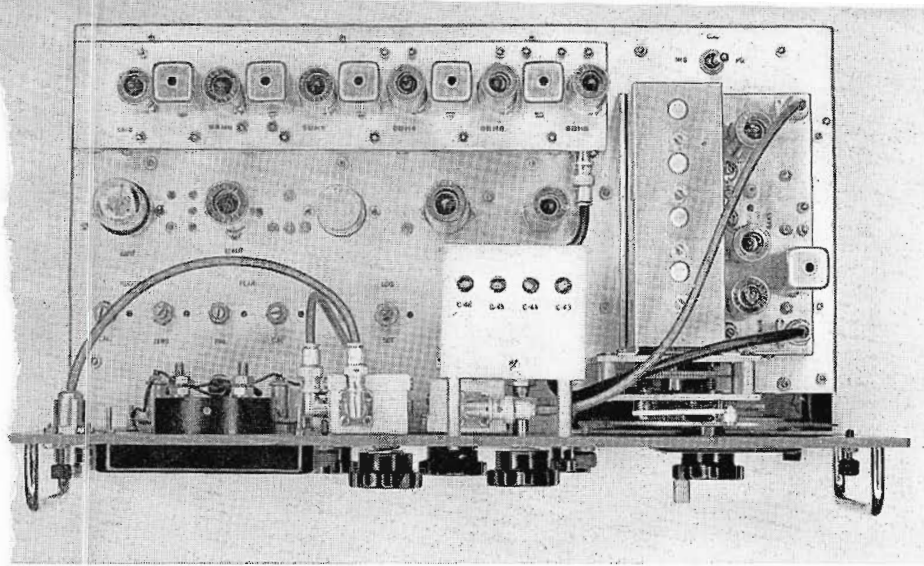

FIG. 3. Top view of the BW-7A receiver portion showing location of components and tubes.

Since means are available for standardizing the gain of the receiver and varying this gain in known increments, the test set constitutes an R-F voltmeter for general laboratory work. Likewise, engineers engaged in receiver work will find the wide range and accuracy of the signal generator portion of the test set of particular advantage in their work. The circuitry allows peak of pulse type of signals to be measured. Measurements may be made on either the "Average" value or on the "Peak of Sync" value of Television signals.

#### BW-7A Features

Except for the tripod-mount dipole antenna in separate carrying case, the instrument is entirely self-contained with a removable protective covering lid. The built-in power supply will operate from either 6 volts d-c or 115 volts 50/60 cycles merely by attaching the proper power cable.

Monitoring by headphones for signal identification is provided for either AM or FM modulation. Provision has been made to operate an Esterline-Angus 1 ma recorder. This may be used for linear response or "log" response. The indicating instrument employs a logarithmic scale which is ideally suited to Field Intensity measurements.

TV signal measurements may be made on the "Average" value or the "Peak of Sync" value.

The dipole antenna system consists of a vertical mast, with the rods forming the dipole pivoted to an insulating plate at the top of the upright. The mast is tripod supported. A scale is engraved on the upright of correctly setting the rod length for a given frequency. For vertically polarized radiation, an extension rod with a T-fitting at one end is first attached to the tripod, and the mast of the dipole section inserted in the horizontal member of the T.

It has long been recognized that a substitution type of field strength measurement could, when the proper precautions

are taken, be made the most accurate of any known method of measuring this quantity. When used for this type of measurement, the calibrated dipole receiving antenna is connected to the receiver portion of the test set and the gain and step attenuators adjusted until the reading on the output meter is full scale. The input of the receiver is then switched to the signal generator and the output of the signal generator adjusted until the same reading is obtained. The field strength is then known from the effective height of the antenna and the output of the signal generator.

If it is not desirable to make this substitution for each measurement, the instrument may be made direct reading in field strength at any given frequency with somewhat less accuracy (attenuator ratios and overall linearity then figure into the final reading) by setting the signal generator to a convenient setting and adjusting the gain of the receiver circuit for correct calibration.

Special provision is made to insure that such variables as the attenuation of the antenna transmission line with frequency, the absolute value of the receiver input termination, and other factors affecting the accuracy as a field strength meter are compensated for. A calibration curve is provided including the effect of antenna, balun, transmission line and attenuator steps.

#### BW-7A Circuit Description

The R-F amplifier is a 6J4 grounded grid stage. The dynamic input impedance of this tube provides about one-half the required load on the input cable while a resistor provides the additional amount needed. The R-F stage is coupled to a 6AK5 pentode-connected mixer through a double-tuned, capacitive-coupled network. This configuration produces a high I-F rejection. A 6AB4 triode oscillator is used and is capacitively coupled to the mixer grid circuit.

The I-F attenuator is the conventional capacity divider type connected to the output of the first I-F transformer. Additional attenuator steps are provided ahead of the first R-F stage.

The main I-F amplifier consists of four 6BH6 tubes with double-tuned, transformer-coupling elements. Overall gain adjustment is made by a bias control on the first and third stages. "Log" compression is obtained by supplying a portion of the output rectified signal as bias to the second stage. FM detection is obtained in a 6AL5 Foster-Seely discriminator driven by a 6BH6 limiter. A 12AU7 twin triode is used to supply audio power to the "Phones" jack. The signal amplitude detector is a type 1N34A crystal and a 12AU7 is provided in a voltmeter bridge. Measurements may be read on the average value or "Peak of Sync" on the logarithmic scale indicating instrument or on a recorder through the 6SN7 recorder amplifier.

The dual input power supply employs a selenium bridge rectifier to improve efficiency and reduce the size and weight of the supply. Voltage regulation is obtained with an OA2.

#### BW3A for UHF Television

The RCA BW-3A for the UHF frequency range from 470 mc to 900 mc provides essentially the same operating features as the BW-7A. The preproduction models have passed all tests with flying colors and early deliveries will soon be announced.

SPECIFICATIONS OF TYPE BW-7A R-F TEST SET	
FREQUENCY RANGE:	54 mc to 240 mc.
TYPE OF TUNING:	Continuous. No band changing necessary in either the receiver or the signal generator.
I-F FREQUENCY:	21.4 mc.
IMAGE REJECTION:	Not less than 37 db anywhere in the tuning range. Typical values are 49 db at 60 mc and 37 db at 240 mc.
SIGNAL GENERATOR:	Output metered and continuously variable from 1.0 uv to 100,000 uv.
FIELD INTENSITY RANGE:	1.5 uv/m to 10 v/m at 54 mc; 6.0 uv/m to 10 v/m at 220 mc.
WEIGHT:	Test Set, 47.5 lbs. Accessories and case, 20 lbs.
DIMENSIONS:	Width, 20 inches; height, 15 inches; depth, 11 inches.

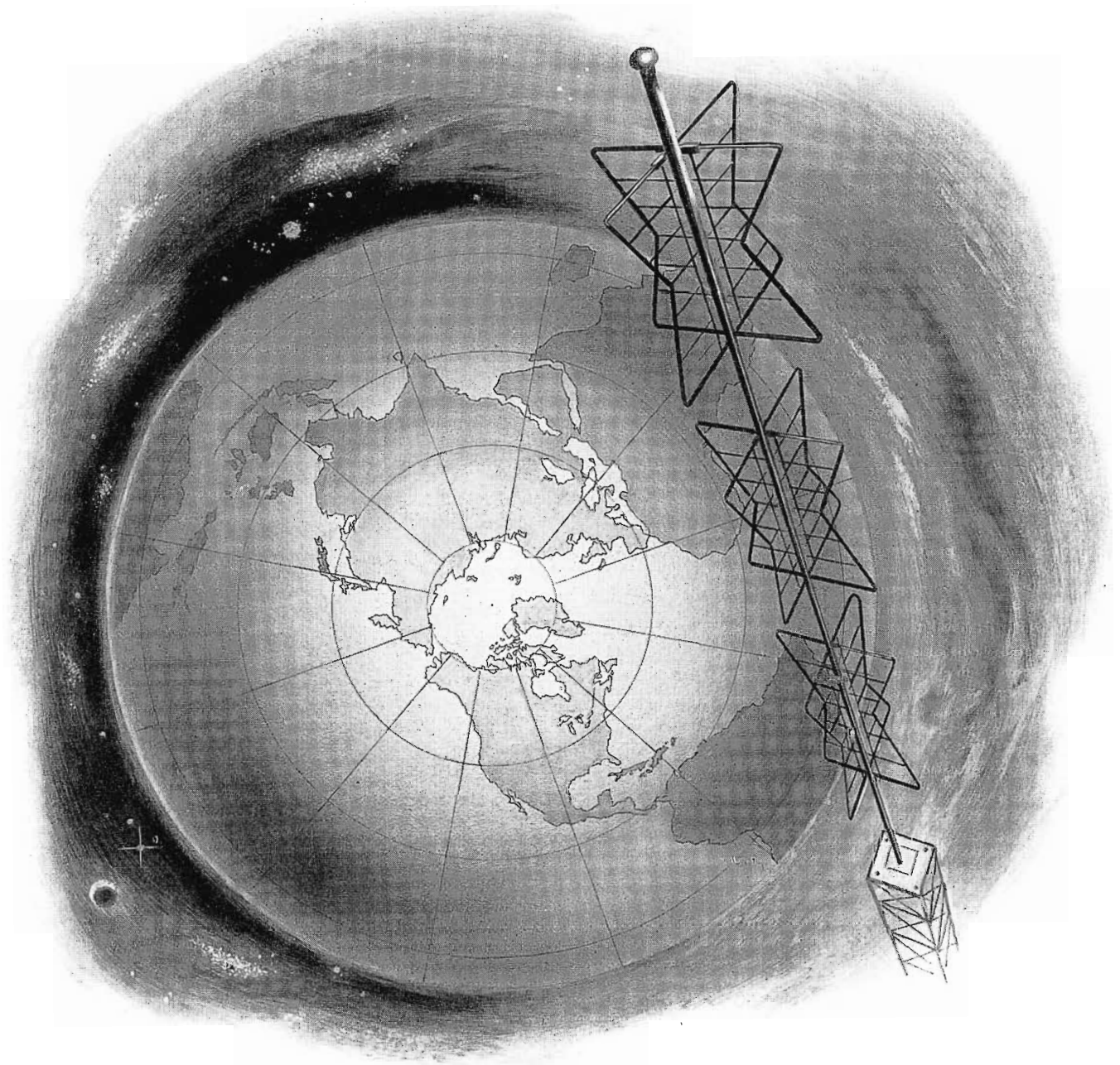

## RCA Television Systems *now serve the world!*

TELEVISION TOWERS are rising round the world. They are symbols of a new era in education and understanding. Increasing numbers of RCA equipped TV stations are on the air or planned for early operation in Brazil, Canada, Cuba, Dominican Republic, Italy, Japan, Mexico, The Philippines and Venezuela.

More and more countries plan for video, the great new teacher. A world

network of TV stations emerges, tapping the reservoirs of culture, improving markets, creating better understanding.

Abroad, as in the U.S.A., RCA has everything for television . . . from camera tube to antenna, from transmitter to receiver . . . and the service of distributors and companies long versed in the electronic needs of their countries.

Only RCA manufactures everything

. . . from TV cameras, through studio and remote facilities which send clear, steady pictures out over the air from RCA transmitters, to the bright, sharp pictures and sound in homes, schools and many other locations.

\* \* \*

Your RCA Distributor or company will be glad to offer information on RCA Television; or write to RCA International Division for the booklet, "World Experience" . . . a stimulating review of TV around the world today.

*World Leader in Radio  
First in Recorded Music  
First in Television*



RCA INTERNATIONAL DIVISION

**RADIO CORPORATION of AMERICA**

RCA BUILDING

30 ROCKEFELLER PLAZA, NEW YORK, N.Y., U.S.A.



New RCA Fleetfone Station Console

# Announcing...

## RCA's new 2-way radio *Fleetfone* "DESK STATION"

Now . . . a 60-watt transmitter plus receiver in a single case. Saves space. Simplifies operation. Makes maintenance easier. Read how . . .

Good news for 2-way radio users! A "desk station" you can install 'most anywhere . . . on a desk, a table, or even on a shelf against the wall.

### 60-watt transmitter exceeds FCC and RTMA requirements

Precision controlled by RCA ovenless crystal unit, with spurious emission reduced to minimum. Two-frequency or three-frequency transmission possible. Very economical to operate. Most tubes work at less than 70%

capacity. Result: longer tube life, less maintenance. Uses standard tubes.

### Receiver gives adjacent channel selectivity

Exceptionally sharp selectivity. Circuits specially designed to give clear reception from mobile transmitters, even in high-interference areas. Two-frequency reception possible by adding another frequency kit. Receiver uses only 5 tube types. Allows minimum spare-tube stock.

### Console built for easy operation and servicing

Sloping front panel, easy access to controls. Built-in direct reading electric clock. Transmitter-receiver chassis

slides out at the top for ready access.

### Get full details . . . mail coupon today

Find out all about this great new "desk station" that gives you full-power performance from a single package. All backed up by RCA . . . world leader in radio. Service available from RCA Service Company if desired.

### FREE BOOKLET . . .

### MAIL COUPON

Dept. 129, RCA Engineering Products,  
Camden, New Jersey

Please send me full information on your  
new RCA Fleetfone Station Console.

Name \_\_\_\_\_

Title \_\_\_\_\_

Company \_\_\_\_\_

Address \_\_\_\_\_

City \_\_\_\_\_ State \_\_\_\_\_

Also, please send me information on use of  
2-way radio in industry checked below:

- General Industry (Utilities, Construction,  
Petroleum, Lumber, Mining, etc.)
- Transportation (Truck, Bus, Taxi, etc.)
- Public Safety (Police, Fire, Ranger, etc.)



**RADIO CORPORATION of AMERICA**



## The tube with the "built-in cash register"



If you operate a 50-kw AM transmitter using high-level modulation . . . if you still use older-type, pure-tungsten filament tubes . . . then this high-power triode can literally save you thousands.

**Take tube cost per hour, for instance:** In a number of 50-kw "AM's", RCA-5671's are still operating after serving over 30,000 hours. Here, as a result of the longer life of the RCA-5671,

actual tube cost runs about 4 cents an hour per tube!

**Take filament-power cost, for instance:** The thoriated-tungsten filament of the RCA-5671 takes 60% less power than pure-tungsten filaments of comparable older tube types—can save you \$1300 or more a year. Take advantage of these major savings. For details, write RCA, Section PI37, Harrison, N. J.

**For tube service in a hurry, call your local RCA Tube Distributor.**



**RADIO CORPORATION of AMERICA**  
ELECTRON TUBES  
HARRISON, N. J.





TYPE TM-2C

*Low-cost, high-quality*

## **TV Picture Monitor**

*—with a dozen uses*

Here is a professional 12½-inch picture monitor you can set up any place in your station—control rooms—announcers' booths—clients' viewing rooms—offices. It is completely self-contained with power supply. It is readily adaptable for portable service. Picture quality meets the requirements of the most critical director.

In the TM-2C, 6-Mc bandwidth permits use of closed-circuit signals—such as the signal from a control room. High-impedance video input makes it possible to terminate the signal in the monitor—or to “loop” the

signal through several monitors. Vertical scanning can be switched for “mirror viewing.” Removable controls make it easy to operate the unit “remote-control” (from a program console, for example).

A special version of the TM-2C . . . using a 10-inch picture tube . . . is available for rack-mounting, or as a monitor in a program console.

One of the handiest video units a station can own. Order yours from your RCA TV Equipment Representative. Or from Dept. 19LA, RCA Engineering Products, Camden, N. J.

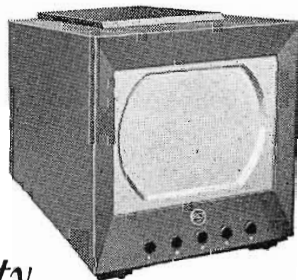

**TELEVISION BROADCAST EQUIPMENT**  
**RADIO CORPORATION of AMERICA**  
**ENGINEERING PRODUCTS DEPARTMENT, CAMDEN, N. J.**

In Canada: RCA VICTOR Company Limited, Montreal

## **PROTECT YOUR BROADCAST INVESTMENT WITH RCA CONTRACT SERVICE**

### **RCA SERVICE INCLUDES:**

- Complete inside proof-of-performance measurements and preparation of data.
- Complete checkup of antenna and transmission line system.
- Instruction on latest engineering and adjustment techniques for your equipment.
- Complete checks of transmitted signal quality with preventive maintenance recommendations.

Find out how RCA Contract Service minimizes equipment breakdowns. Call WOODLAWN 3-8000, Ext. PG-327, or write Broadcast Service Section, RCA Service Company, Inc., Camden, New Jersey.



**RCA SERVICE CO., INC.**  
 A Radio Corp. of America Subsidiary  
 Camden 2, New Jersey

## **RCA Makes Old Cameras Perform Like New!**

### **RCA CAMERA OVERHAUL INCLUDES:**

- Modification of circuits on RCA cameras, models TK-10 and TK-30 so that they are completely up to date—original picture quality restored.
- A complete check of all mechanical parts and their replacement where necessary.
- Refinishing of exteriors of camera and viewfinder cases.
- Thorough circuit and performance checks to insure original picture quality.

To schedule your studio or field camera for reconditioning, call WOODLAWN 3-8000, Ext. PG-327, or write Broadcast Service Section, RCA Service Company, Inc., Camden, N. J.



**RCA SERVICE CO., INC.**  
 A Radio Corp. of America Subsidiary  
 Camden 2, New Jersey

# EVERYTHING FOR

1. RCA Film Camera  
Type TK-20C

2. RCA 16mm Television Film  
Projector Type TP-16D

3. RCA 35mm Television Film  
Projector Type TP-35C

4. RCA Film Multiplexer  
Type TP-9B

Film Projection Room, complete with new RCA film camera, two new film projectors, and multiplexer. Can be remote-controlled from your audio/video console.



# CO-ORDINATED

# FILM SYSTEMS

**1. New Film Camera Type TK-20C** produces clear pictures approaching the quality of studio pick-ups. Low noise level. No image "sticking." No constant shading needed. It looks equally well with the 16mm projectors, and 3" x 4" opaque slide projectors.

**2. The 16mm TV Film Projector Type TP-16D** makes film programming practical, economical. It's entirely self-contained. It's designed and built only by RCA.

**3. The 35mm TV Film Projector TP-35C** uses a highly efficient pulsed light source. The projector operates without a shutter mechanism, is completely self-enclosed (including film mechanism) . . . and it's designed and built by RCA!

**4. Type TP-9B Film Multipler** enables you to use two projectors with one film camera for maximum program flexibility.

**5. TK-3A Flying Spot Camera** produces high-quality video signals from 2" x 2" transparencies. Dual channel increases flexibility, provides for lap dissolve and switching between channels. Ideal for titles, spots, commercial inserts (spots), test patterns. Special Effects Amplifier TA-15A is an ideal accessory.

RCA is your headquarters for a complete line of television film equipment. If you need 16mm or 35mm television projection equipment, RCA has the finest. If you want a revolutionary film camera, RCA has it. Kinescope recording equipment, automatic slide projectors, flying spot cameras, automatic processors, and miscellaneous accessories such as rewinders, reels, slide viewers, and film cleaning equipment, also are available.

RCA equipment can be used in many different combinations to fit your

planning and budget. For example, you can start with a complete film projection setup as illustrated here. Or you can start simply with a film projector, and add facilities as your program service grows. Note this fact, too: *RCA Service Company engineers are available on a nationwide basis to keep your RCA film equipment in top condition!*

Film systems planning is another RCA television service available to you through your RCA Broadcast Sales Representative. Take advantage of his broad experience.

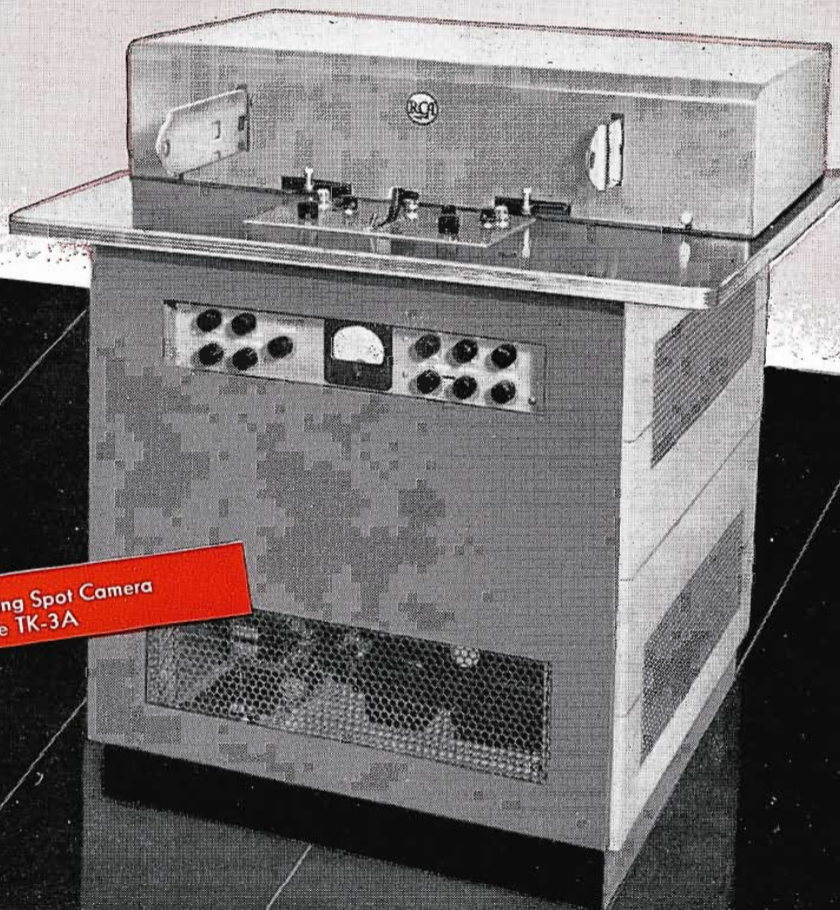

5. RCA Flying Spot Camera  
Type TK-3A



**RADIO CORPORATION of AMERICA**  
ENGINEERING PRODUCTS DEPARTMENT

CAMDEN, N.J.

# Completely

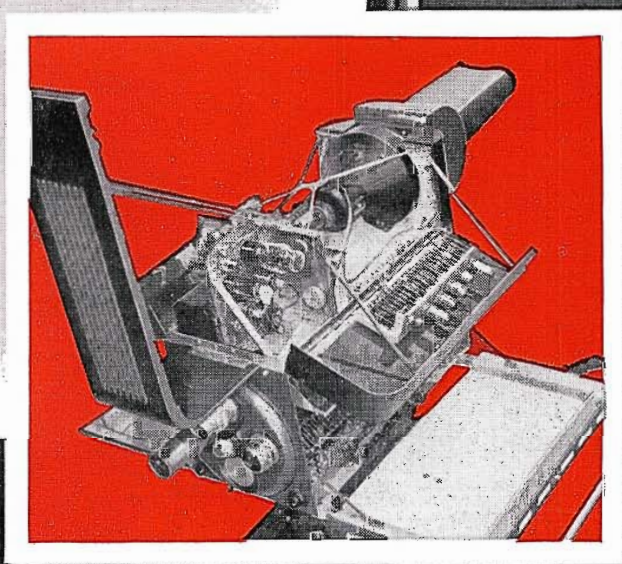
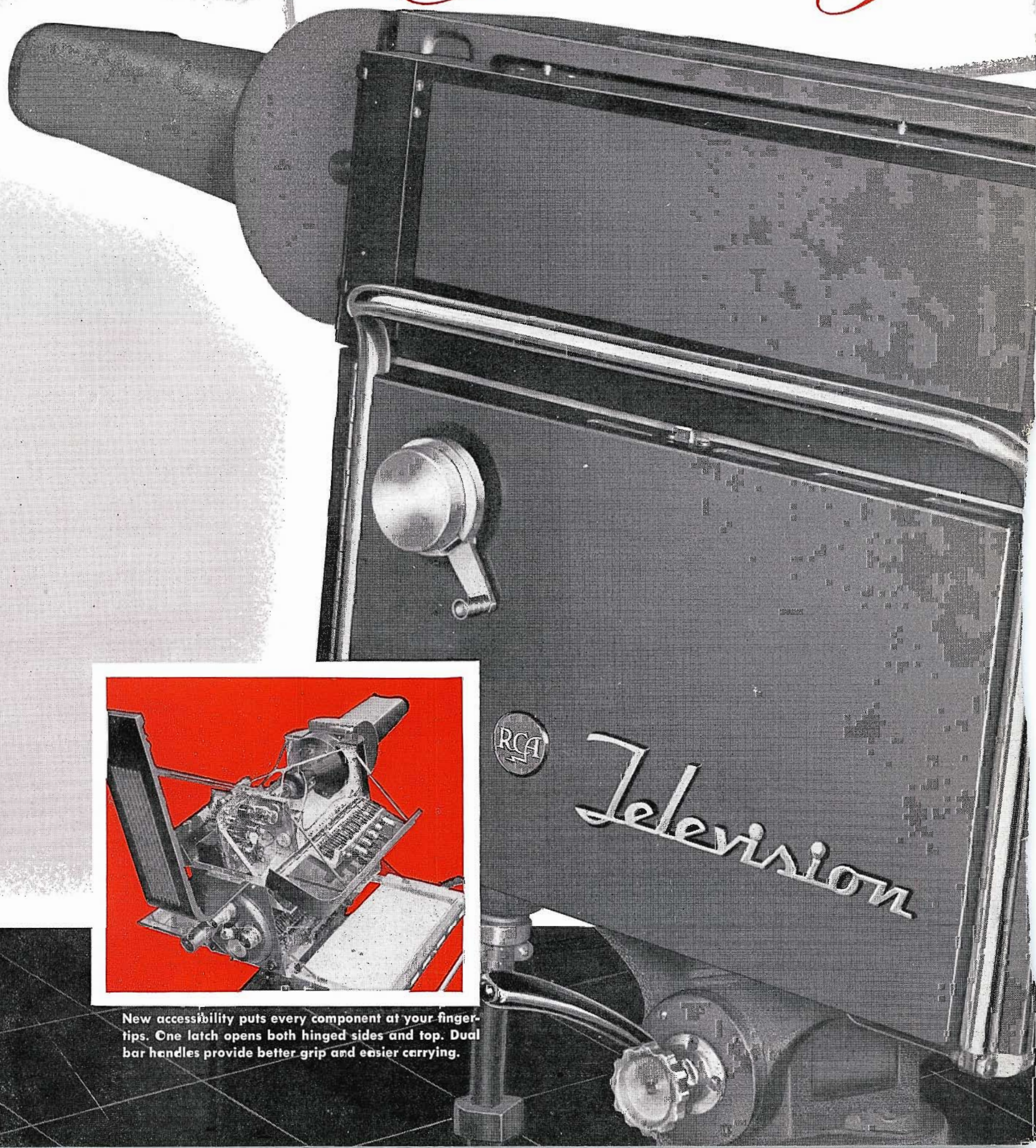

New accessibility puts every component at your fingertips. One latch opens both hinged sides and top. Dual bar handles provide better grip and easier carrying.

# New!

## RCA TV CAMERA

**TYPE TK-11A**

Here is the all-new TV camera the industry is talking about. The camera the leading networks are planning to use in their new Hollywood studios! The camera which will be used in most of the new stations this year—and next!

Leading network engineers (after

**NEW** 7-inch viewfinder picture tube produces larger, brighter, and sharper pictures to help the cameraman.

**NEW** plug-in, high-stability video amplifier—with frequency response uniform to 8.5 Mc.!

**NEW** fixed-position alignment coil for the Image Orthicon. Electrical control of coil eliminates all mechanical adjustments!

careful tests) have proclaimed the TK-11A the finest camera ever produced, easiest in the world to handle, and the simplest one to get at.

The TK-11A has all the proven performance of the world-renowned RCA TK-10—plus these new features:

**NEW** plug-in blower for cooling the deflection coil and the Image Orthicon!

**NEW** electronic-protection system guards your Image Orthicon against deflection failure, or loss of driving signals.

**NEW** "overscan" control takes burden off Image Orthicon during warm-ups and rehearsals; new vertical reverse switch for film pick-ups.

For complete information on the TK-11A,  
call your RCA Broadcast Sales Representative.



**RADIO CORPORATION of AMERICA**  
ENGINEERING PRODUCTS DEPARTMENT  
CAMDEN, N. J.

# New Pressure Microphone

*TV style!*



**BK-1A**  
All-New  
Pressure Microphone  
AM, FM and TV

THIS IS THE NEW MICROPHONE that made broadcast and television history at the political conventions. It includes every outstanding characteristic of the RCA 88-A, which it replaces, plus new advantages found in no other microphone in its price range or class. Check the facts!

- Type BK-1A is unobtrusive, even in the "close-ups." New styling, non-reflecting finish blends right into the TV picture
- Type BK-1A is absolutely insensitive to air blast and vibration—ideal for "close-ups"
- Type BK-1A has a frequency characteristic that is independent of distance from the sound source
- Type BK-1A has uniform response over the essential audio range
- Type BK-1A can be used in any kind of weather
- Type BK-1A detaches from base for hand-announcing (it can also be mounted on floor stands)
- Type BK-1A is equipped with a ball-and-swivel mount—can be turned in any direction
- Type BK-1A is only 8 inches high; weighs just 19 oz. (less base and cable)

For details and delivery information on this new remarkable semi-directional microphone, call your RCA Broadcast Sales Representative

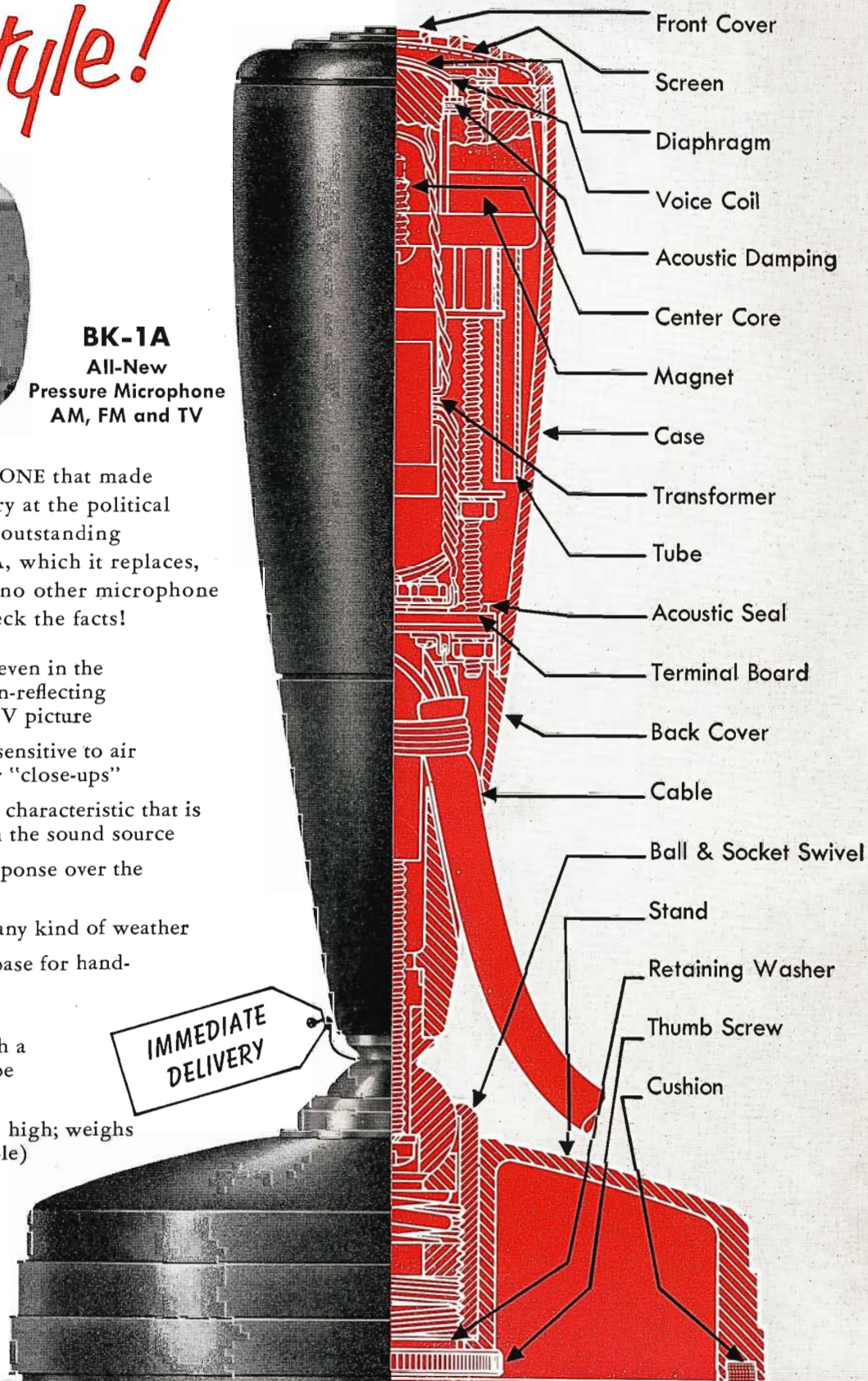

**RADIO CORPORATION of AMERICA**  
ENGINEERING PRODUCTS DEPARTMENT  
CAMDEN, N.J.